



Radio and television interference

“Warning — This equipment has been verified to comply with the limits for a Class B computing device, pursuant to Subpart J, of Part 15, of FCC rules. Operation with non-certified or non-verified equipment is likely to result in interference to radio and TV reception.”

The equipment described in this manual generates and uses radio-frequency energy. If it is not installed and used properly, that is, in strict accordance with our instructions, it may cause interference with radio and television reception.

This equipment has been tested and found to comply with the limits for a Class B computing device in accordance with the specifications in Subpart J, of Part 15, of FCC Rules. These rules are designed to provide reasonable protection against such an interference in a residential installation.

However, there is no guarantee that the interference will not occur in a particular installation. If this equipment does cause interference to radio or television reception, which can be determined by turning the equipment on and off, the user is encouraged to try to correct the interference by the following measure:

- Disconnect other devices and their input/output cables one at a time. If the interference stops, it is caused by either the other device or its I/O cable.

These devices usually require Roland designated shielded I/O cables. For Roland devices, you can obtain the proper shielded cable from your dealer. For non Roland devices, contact the manufacturer or dealer for assistance.

If your equipment does cause interference to radio or television reception, you can try to correct the interference by using one or more of the following measures:

- Turn the TV or radio antenna until the interference stops.
- Move the equipment to one side or the other of the TV or radio.
- Move the equipment farther away from the TV or radio.
- Plug the equipment into an outlet that is on a different circuit than the TV or radio. (That is, make certain the equipment and the radio or television set are on circuits controlled by different circuit breakers or fuses.)
- Consider installing a rooftop television antenna with coaxial cable lead-in between the antenna and TV.

If necessary, you should consult your dealer or an experienced radio/television technician for additional suggestions. You may find helpful the following booklet prepared by the Federal Communications Commission:

“How to Identify and Resolve Radio-TV Interference Problems”

This booklet is available from the U.S. Government Printing Office, Washington, D.C., 20402, Stock No. 004-000-00345-4.

Bescheinigung des Herstellers /Importeurs

Hiermit wird bescheinigt, daß der/die/das

ROLAND SUPER QUARTET MKS-7

.....
(Gerät, Typ. Bezeichnung)

in Übereinstimmung mit den Bestimmungen der

Amtsbl. Vfg 1046 / 1984

.....
(Amtsblattverfügung)

funk-entstört ist.

Der Deutschen Bundespost wurde das Inverkehrbringen dieses Gerätes angezeigt und die Berechtigung zur Überprüfung der Serie auf Einhaltung der Bestimmungen eingeräumt.

Roland Corporation Osaka / Japan

.....
Name des Herstellers/Importeurs

1 PANEL DESCRIPTION

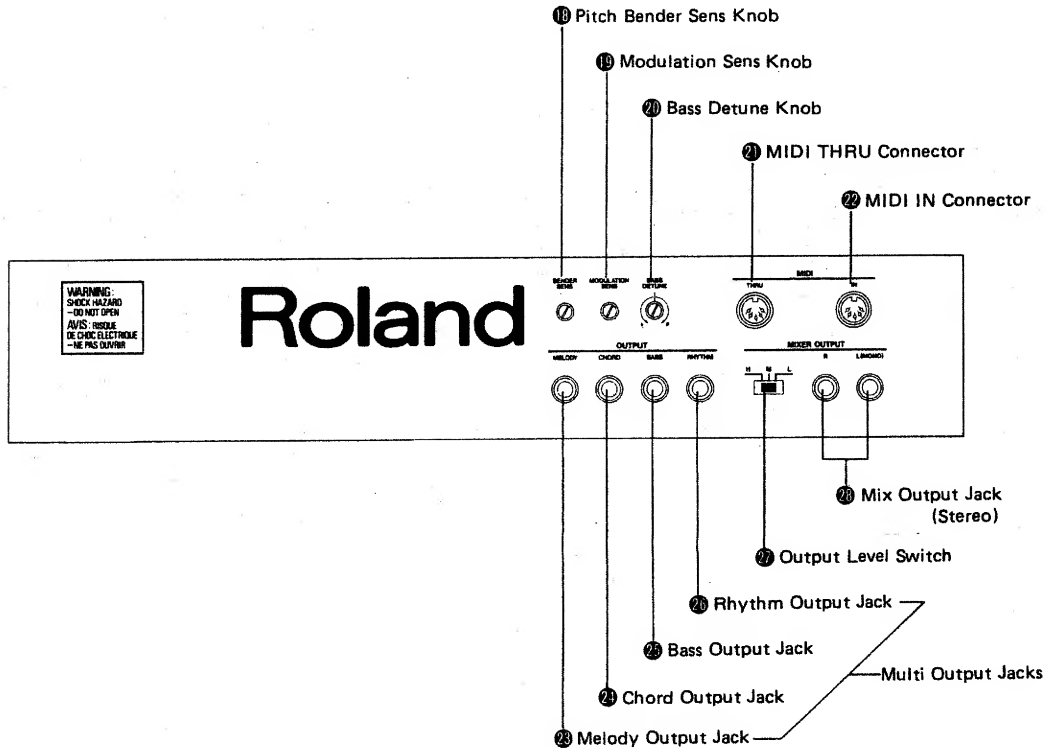
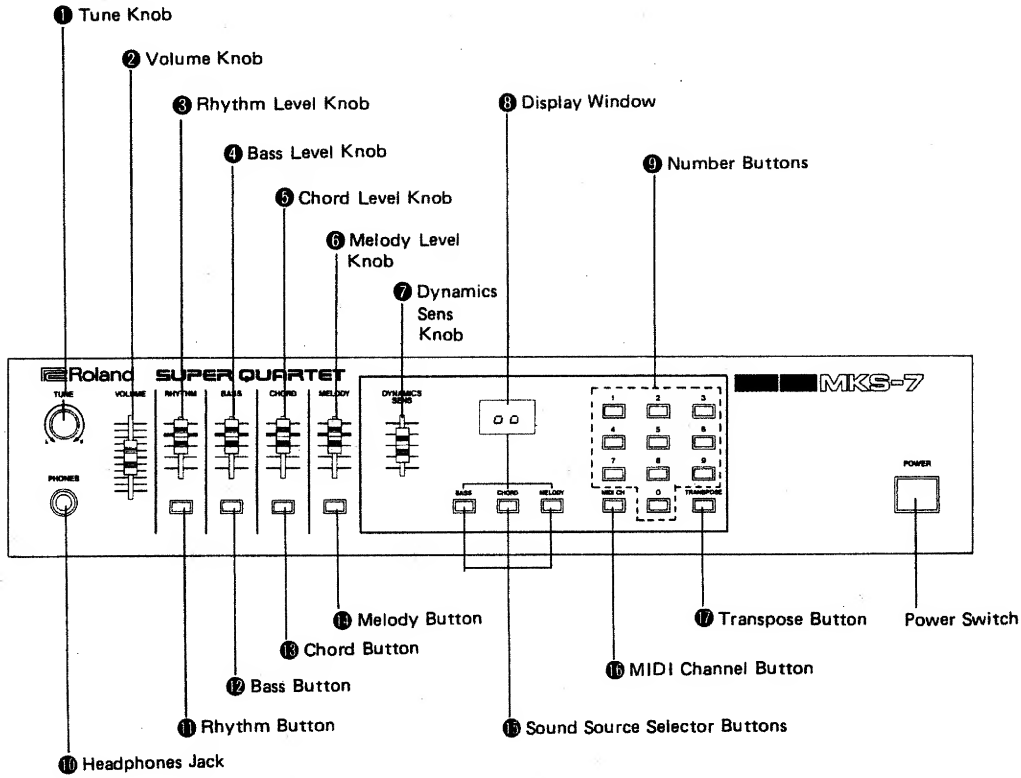

IMPORTANT NOTES

Power Supply

- The appropriate voltage to be used is shown on the name plate of the rear panel. Be sure that it meets the line voltage system in your country.
- Do not use the same socket that is used for any noise generating device, such as a motor, or variable lighting system.
- When setting up the MKS-7, be sure that all the units are turned off.
- This unit might not work properly if turned on immediately after turned off, or if the power cable is plugged in with the unit turned on. If this happens, simply turn the unit off, and turn it on again after a few seconds.
- This unit might get hot while operating, but there is nothing to worry about it.

Cleaning

- Use a soft cloth and clean only with a mild detergent.
- Do not use solvent such as paint thinner.

Location

- Operating the MKS-7 near a neon or fluorescent lamp may cause noise interference. If so, change the angle or position of the MKS-7.
- Avoid using the MKS-7 in extreme heat or humidity or where it may be affected by dust.

CONTENTS

1	PANEL DESCRIPTION	3	4	APPLICATIONS	18
2	CONNECTIONS	6	1.	MIDI Functions	18
3	OPERATION	7	2.	Whole Mode	19
1.	MIDI Channel Setting	7	3.	Tone Color Selection (2)	21
2.	Tone Color Selection (1)	9	4.	System Examples	22
3.	Tuning	12	5	SPECIFICATIONS	24
4.	Level Setting	12			
5.	Setting Dynamics Sensitivity	13			
6.	Key Transpose	14			
7.	Pitch Bender and Modulation Sensitivity	15			
8.	Other Useful Information	16			

OUTLINE

The Roland Super Quartet MKS-7 is a versatile sound module designed for MIDI devices.

The MKS-7 consists of 4 Blocks, Melody, Chord, Bass and Rhythm. Each block can operate in a different MIDI channel.

The Melody block is a 2 voice polyphonic synthesizer, the Chord is 4 voices, the Bass is monophonic, and the Rhythm, which is P C M sound module, is 11 voices.

The MKS-7 has 100 different preset tone colors for Melody and Chord Blocks and another 20 for Bass. You can select any of these just by flick of a switch.

System Setup

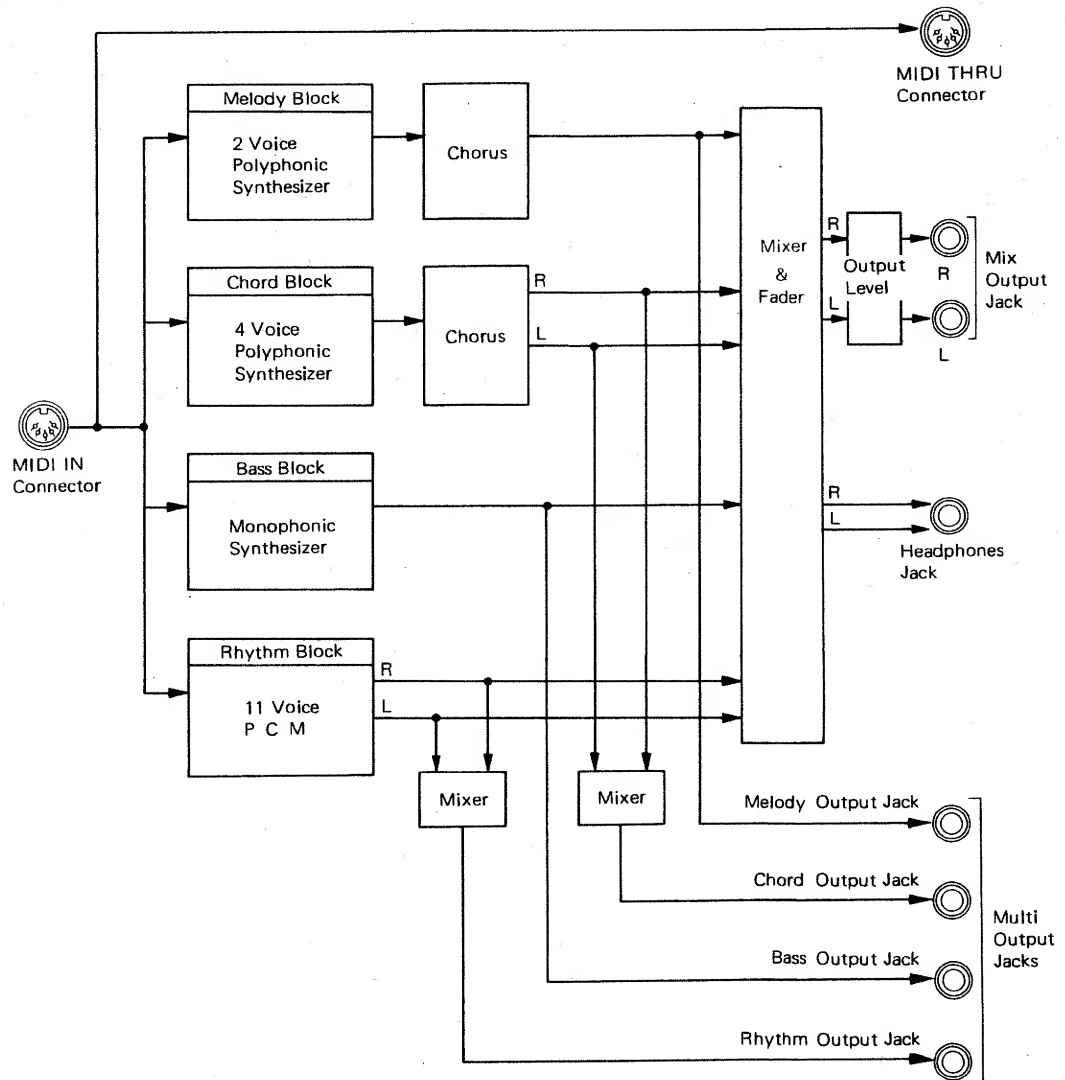

2 CONNECTIONS

* Do not connect more than three devices through MIDI THRU's. For connecting more devices, use the MIDI THRU BOX MM-4 (optional).

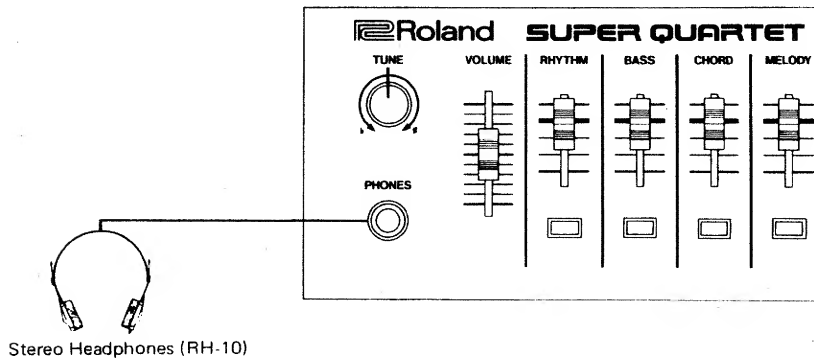
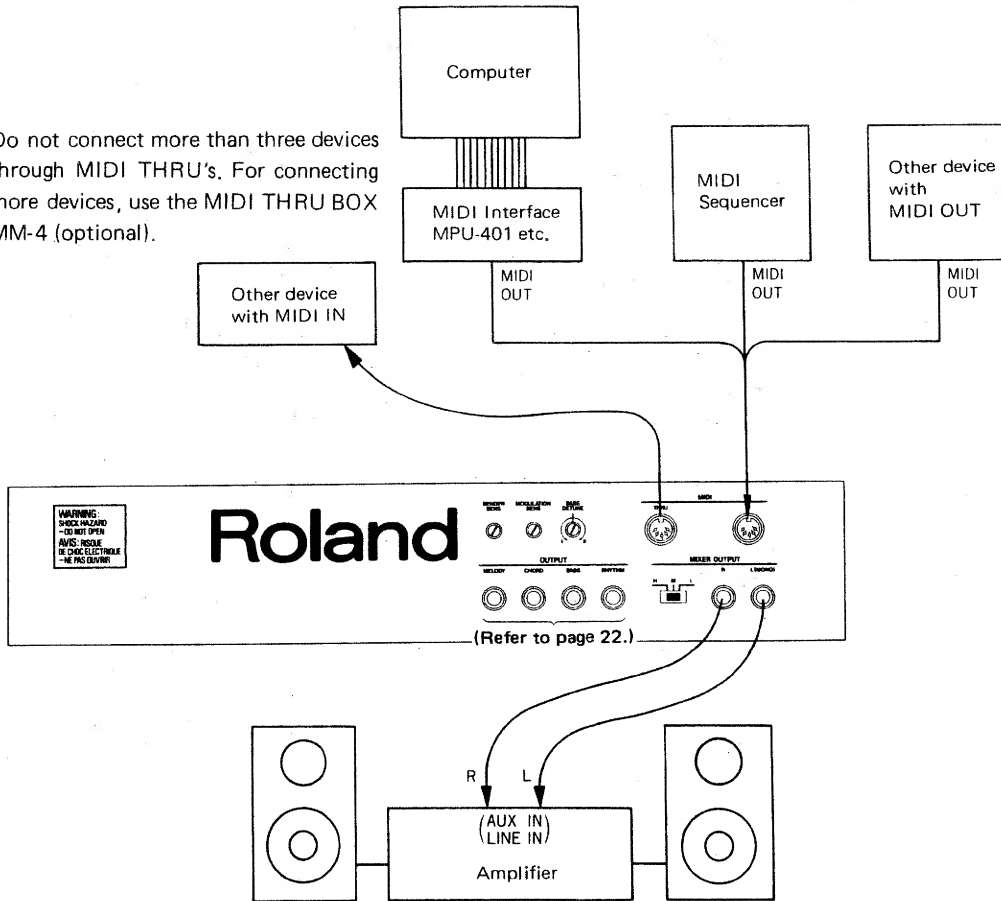

3 OPERATION

1. MIDI Channel Setting

Each block can select a MIDI Channel of 1 to 16. To operate the MKS-7, it is essential to match the channel number of each block to that of the MIDI signal coming in the MKS-7.

When the power is applied, the MKS-7 defaults to the MIDI Channel numbers as shown in the right table.

Block	MIDI Channel
Melody	1
Chord	3
Bass	2
Rhythm	10

Operation

- 1 Push the MIDI Channel Button 16.

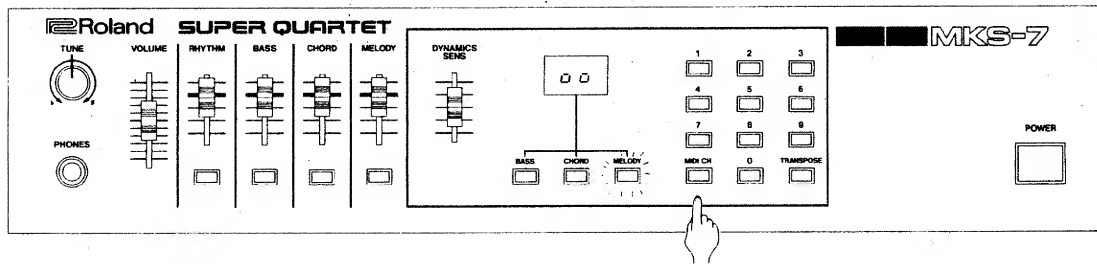

The Display Window 8 shows --, and the Rhythm Button 11, Bass Button 12, Chord Button 13, and the Melody Button 14 flash.

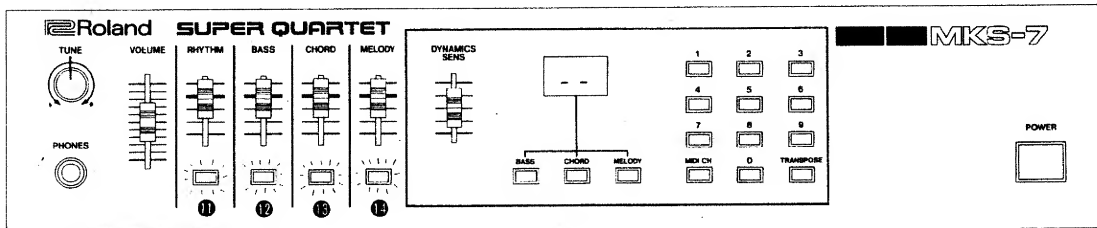

- ② Select the Block you like by pressing the corresponding button.

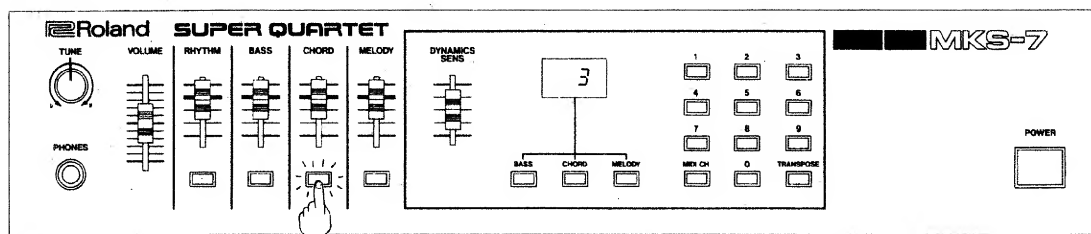

(e.g. To change the MIDI Channel of the Chord Block to 16)

The Display ❸ shows the current MIDI Channel number of the selected block.

- ③ While still holding the corresponding Button down, set the MIDI Channel you want by using the Number Buttons ❹.

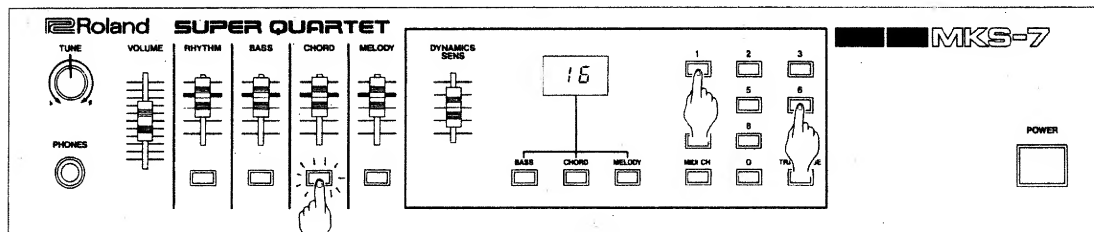

(While holding the button down)

The Display ❸ shows the MIDI Channel number you have set.

- ④ Press the MIDI Channel Button ❻.

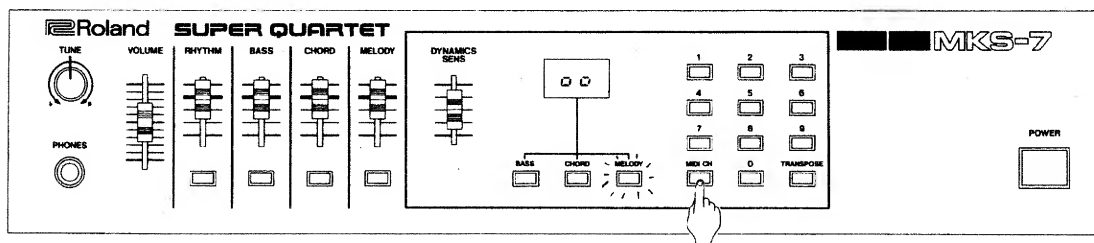

2. Tone Color Selection (1)

The MKS-7 has 100 different tone colors (00 to 99) for the Melody and Chord, and 20 (00 to 19) for the Bass. Any of these tone colors can be called easily by pushing buttons or externally with MIDI. (Refer to page 21.)

When power is applied, the MKS-7 defaults to the tone colors as shown in the right table.

Block	Tone Color Number
Melody	00
Chord	00
Bass	00

- * The Melody and the Chord can take on a vibrato effect by using MIDI Control Change message (= Modulation message).

Operation

- Call the Block that contains the tone color you want, by pressing a Sound Source Selector Button (Bass, Chord or Melody).

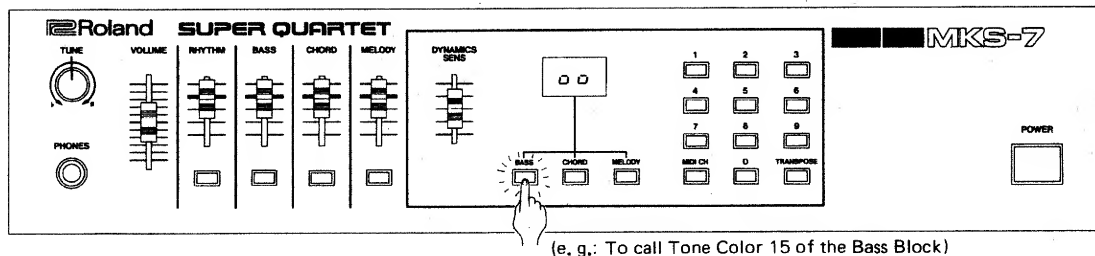

The pressed button lights up, and the Display (8) shows the current tone color number.

- Call the tone color you like by using the Number Buttons (9).

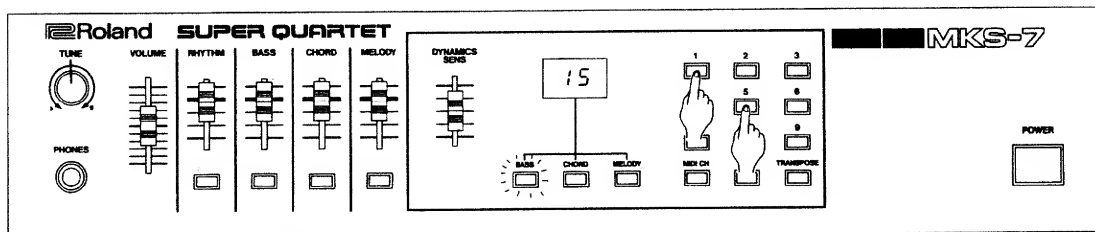

The Display (8) now shows the tone color number you have called.

3. Tuning

The MKS-7 has the Bass Detune Knob ⑭ as well as a usual Tune Knob ①.

a. Tune Knob ①

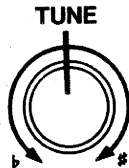

Use this knob to tune the MKS-7 with other musical instrument. (This knob can simultaneously tune all the Blocks: Melody, Chord and Bass.)

* The Chord Block is set to 2 cent lower than the Melody, except when in the Whole mode (see page 19).

b. Base Detune Knob ⑭



This knob can detune the pitch of the Bass Block by ± 50 cent from the Chord and Melody.

* The pitch does not change while adjusting the Bass Detune Knob. First adjust the knob then play a key, and now the pitch of the sound is altered. You may need to repeat this procedure quite a few times to successfully complete tuning.

4. Level Setting

The MKS-7 has a separate level control for each Block of Melody, Chord, Bass and Rhythm enabling individual level setting.

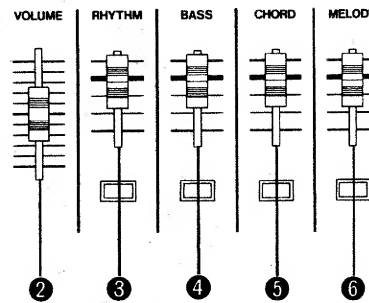

a. Volume Knob ②

This adjusts the overall volume of the MKS-7.

b. Rhythm Level Knob ③

This adjusts the volume of Rhythm Block.

c. Bass Level Knob ④

This adjusts the volume of Bass Block.

d. Chord Level Knob ⑤

This adjusts the volume of Chord Block.

e. Melody Level Knob ⑥

This adjusts the volume of Melody Block.

f. Output Level Switch ⑯

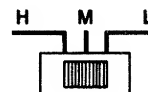

Select H (high), M (medium) or L (low) depending on the rated input level of the amplifier (or mixer) you use.

KEYBOARD AMP	M/H
AUDIO AMP	H
P.A. MIXER	L/M/H
GUITAR AMP	L/M
	etc.

5. Setting the Dynamics Sensitivity

“Dynamics sensitivity” is the function that can alter the volume or tone color depending on how hard the key is attacked.

Each block of the Melody, Chord and Bass can be individually set the sensitivity of Dynamics effect.

When the MKS-7 is turned on, the Dynamics sensitivity of each block is automatically set to a standard value.

Operation

- ① By pressing the Sound Source Selector Button **⑥**, call the Block whose Dynamics sensitivity you want to change from the standard value.

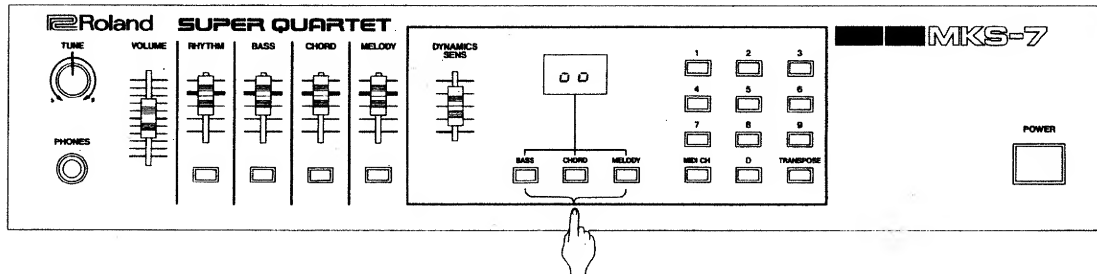

- ② Set the Dynamics Sens Knob **⑦** to your taste. When the knob is moved even slightly, the previous setting will be deleted, and replaced with the current knob position.

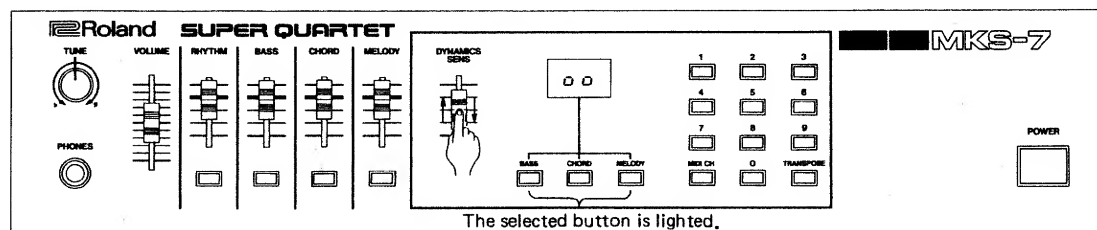

* Lowering the knob too low may decrease the volume.

6. Key Transpose

The MKS-7 features the Key Transpose function that allows transposition in semi-tone steps up to ± 1 octave.

Operation

- 1 Press the Transpose Button **17**.

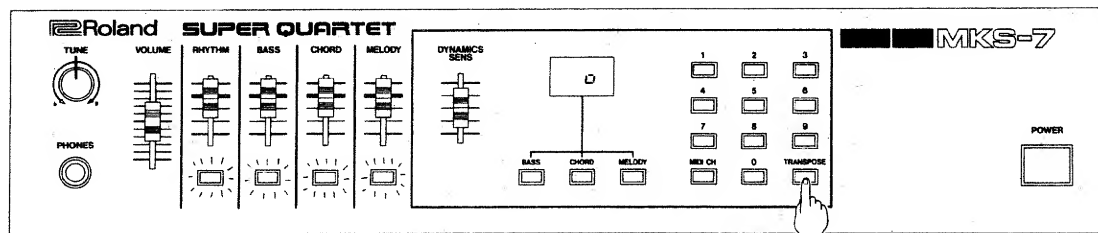

The Display **8** shows the number that represents how many semi-tones are currently transposed from the C key.

- 2 By using the Number Buttons **9** and/or the MIDI Channel Button **10**, enter a new number.

Transpose value 1 means a semi-tone transposition from the C key. To transpose to the key higher than C key, simply enter the appropriate number, but to transpose to lower than C, press the MIDI Channel Button first. For example, to transpose to the lower G, press the MIDI Channel Button **10**, the Number Button 0, then 5.

- 3 Press the Transpose Button **17**.

The Transpose function does not apply to the Rhythm Block.

Key Transpose

Display 8	Transpose Value
12	+ 12
11	+ 11
10	+ 10
9	+ 9
8	+ 8
7	+ 7
6	+ 6
5	+ 5
4	+ 4
3	+ 3
2	+ 2
1	+ 1
0	0
1	- 1
2	- 2
3	- 3
4	- 4
5	- 5
6	- 6
7	- 7
8	- 8
9	- 9
10	- 10
11	- 11
12	- 12

b. Rhythm and Note Number

The Rhythm Block of the MKS-7 operates by Note ON/OFF message. The relation between the keys and drum voices is shown below.

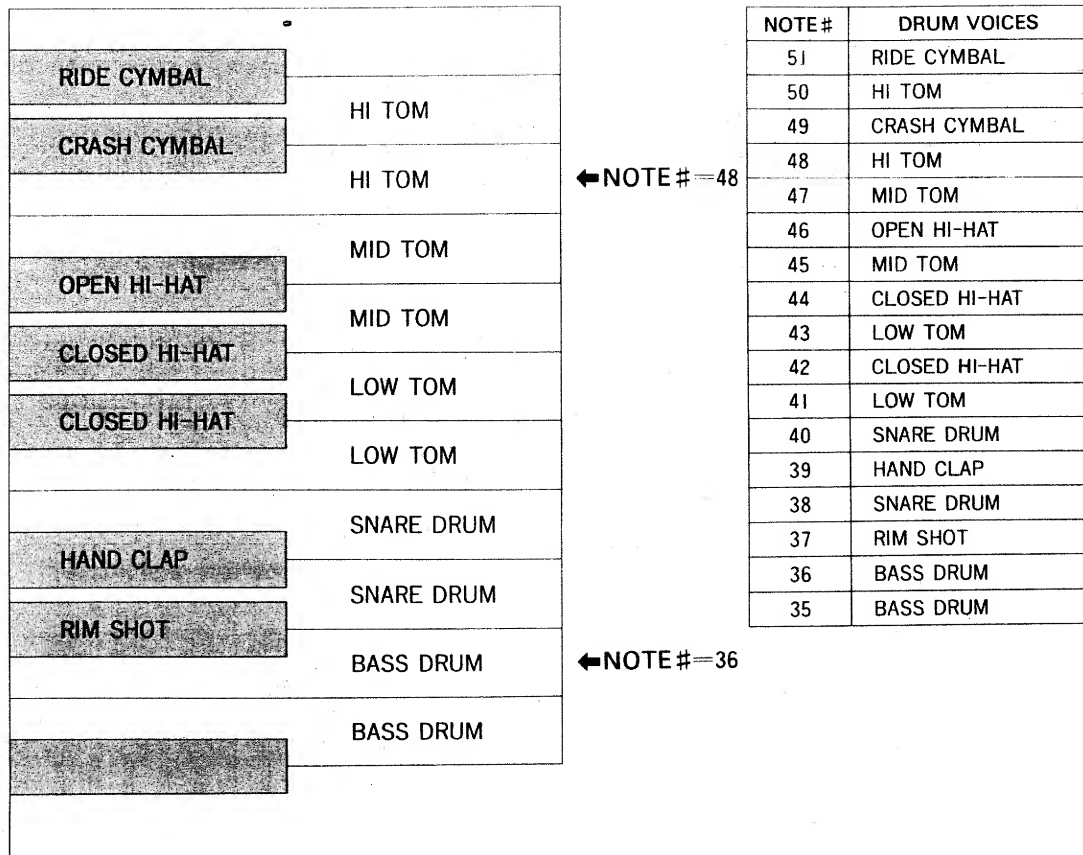

c. The Display reaction at receiving Exclusive message

“Exclusive” is a kind of MIDI message. (Refer to the different volume “MIDI”.) The MKS-7 uses this for editing the parameters of a tone color.

When the MKS-7 receives the Exclusive message, dots will be indicated in the Display ⑧ as shown right.

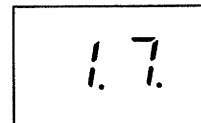

4 APPLICATIONS

1. MIDI Functions





The MKS-7 can reject one or more than one of the following MIDI messages.

- 1 **Hold**
- 2 **Program Change** (Patch Selection message)
- 3 **Pitch Bender, Modulation**
- 4 **Exclusive** (used for editing the parameters of tone color)

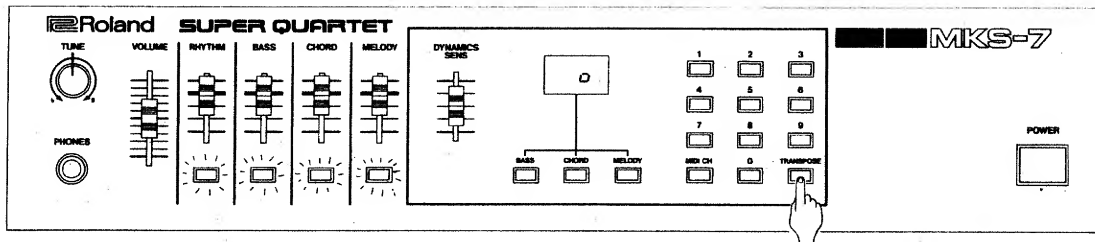
Operation

- ① Push the Transpose Button .



The Rhythm Button , Bass Button , Chord Button  and Melody Button  will all light up. These four buttons now serve as On/Off switches of the above 4 MIDI messages as shown right. When the button is lighted, the corresponding message will be received.

- ② Push the button that corresponds to the MIDI message that you want the MKS-7 to ignore.

The pushed button goes out.

- ③ Push the Transpose Button .

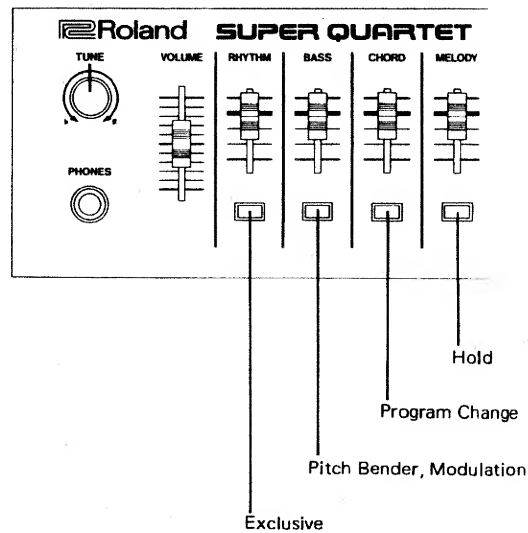

2. Whole Mode

With the MKS-7 set to the Whole mode, the Melody and Chord Blocks are united and act as a six voice synthesizer. That is, the Chord Block becomes six voices, and there is no sound from the Melody Block. To turn the MKS-7 to the Whole mode, take the following operation.

Operation

- 1 Press the MIDI Channel Button **1b**.

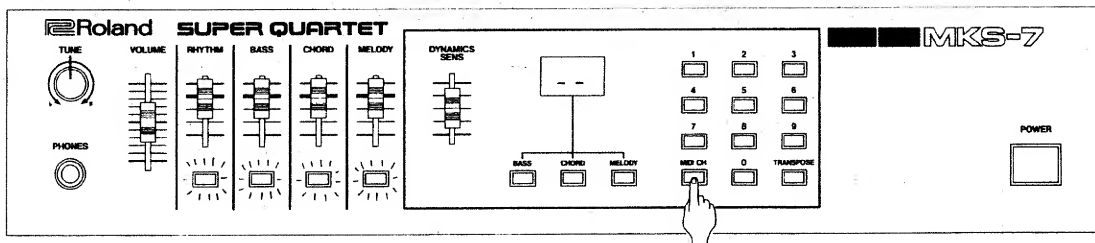

The Display **8** shows and the Rhythm Button **1a**, Bass Button **1c**, Chord Button **1d** and Melody Button **1e** flash.

- 2 While holding the Chord Button **1d**, press the Melody Button **1e**.

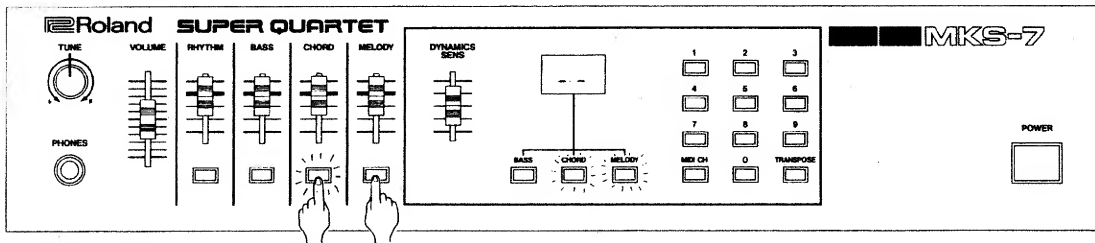

(While holding this button down.)

The both CHORD and MELODY of the Sound Selector Buttons **1d** light, which shows that the MKS-7 is now in the Whole mode.

- 3 Press the MIDI Channel Button **1b**.

< Cancelling the Whole Mode >

Operation

- ① Press the MIDI Channel Button **16**.

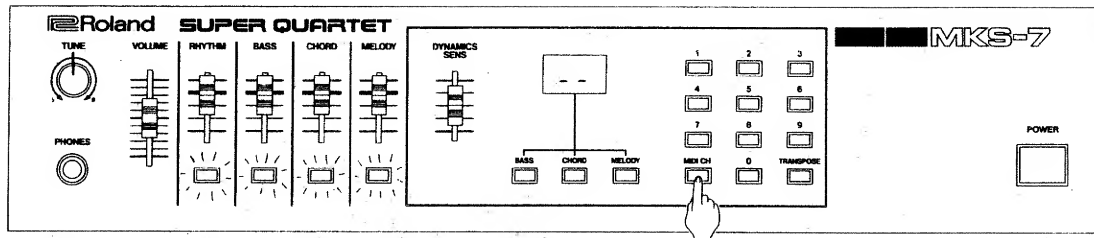

- ② Press the Melody Button **17**.

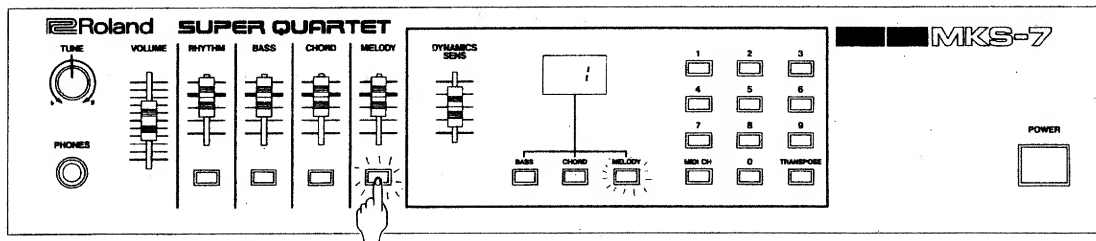

The MELODY of the Sound Selector Button **17** lights up.

- ③ Press the MIDI Channel Button **16**.

* It is also possible to turn the MKS-7 to the Whole mode or cancel it externally by using MIDI. (Refer to "MIDI Implementation Chart".)

* The MIDI Channel set in the Chord Block will be used in the Whole mode. So, when you want to change the Channel number in the Whole mode, change that of the Chord Block.

4. System Examples

a. Using the Multiple Outputs

The MKS-7 has a separate output jack (Multi Out) for each Block. The Multi Out Jack can be effectively used for attaining separate effect in each block.

(e.g.) Delay Machine to Melody Block,
Equalizer to Bass

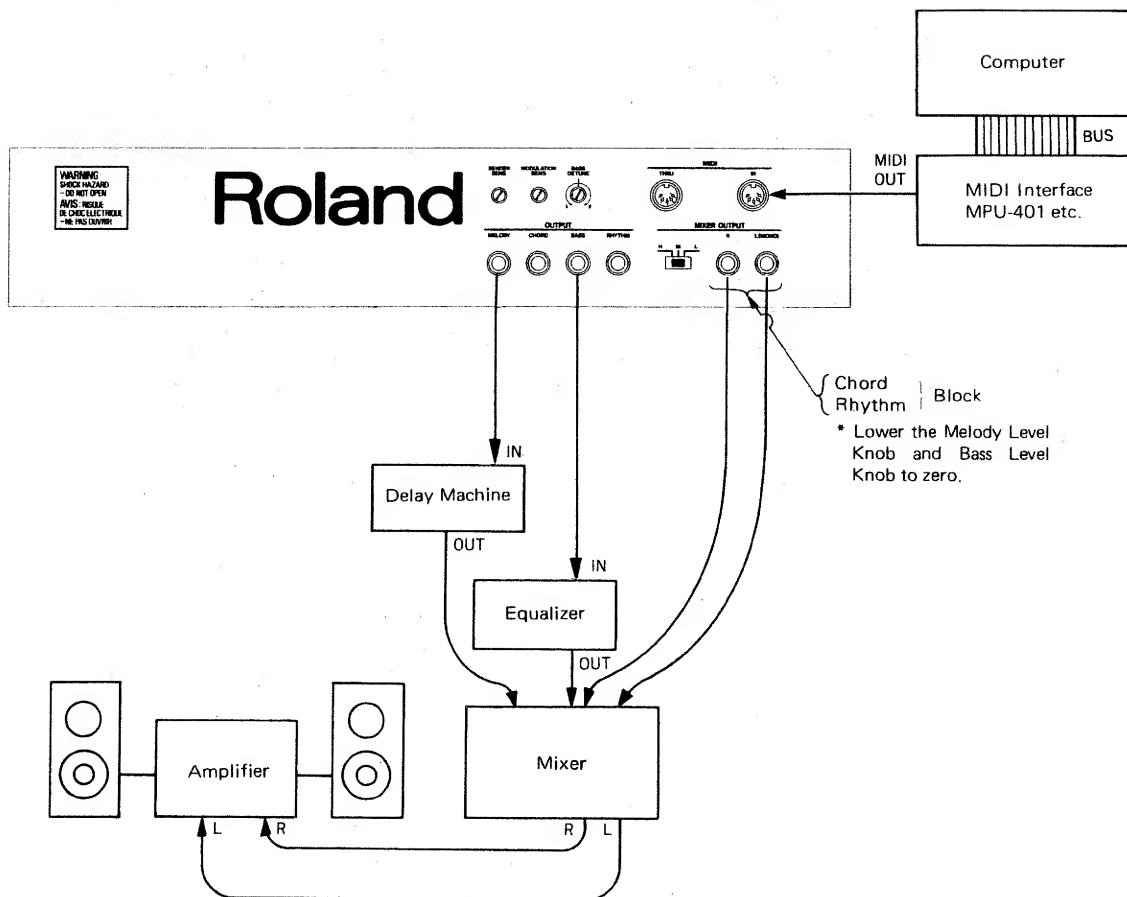

* The signal sent through the Multi Out Jack is not affected at all by the position of the Level Knob or Volume Knob, that is, a signal of a certain level is always sent out.

* Using the Multi Output does not affect the total output of the Mix Out. If you do not want to subtract the output of a certain block, lower the corresponding Level Knob to zero.

* The output from the Multi Output has a phase of exact inversion of the Mix Out.

b. Using a Keyboard Recorder

The MKS-7 can be controlled by the keyboard recorder such as MSQ-100 or MSQ-700.

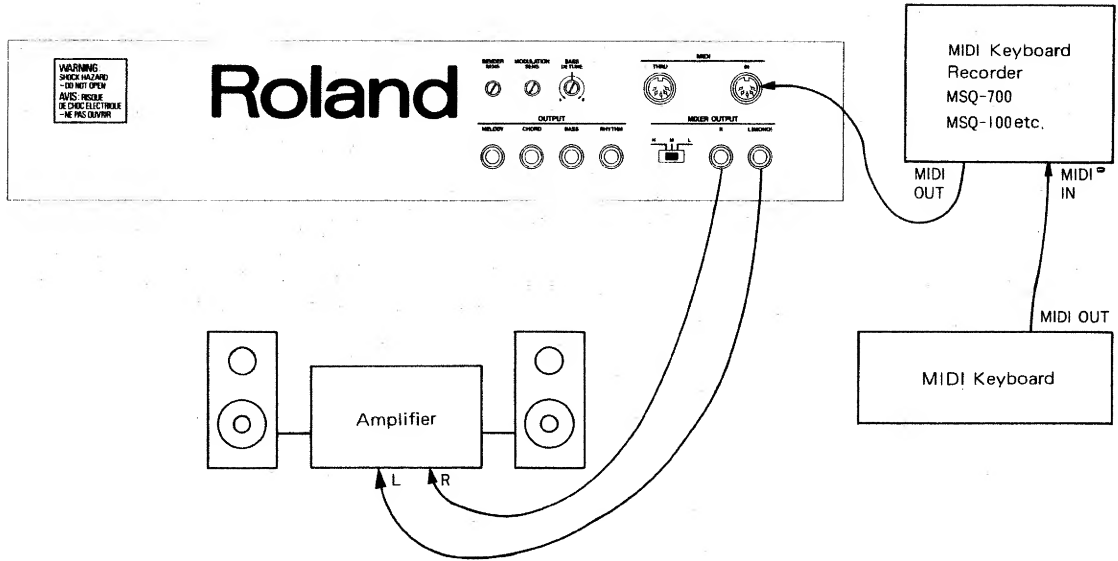

c. As a Minus-one Music

The MKS-7 plays accompaniment, with the Key Transpose function available and the tempo changeable.

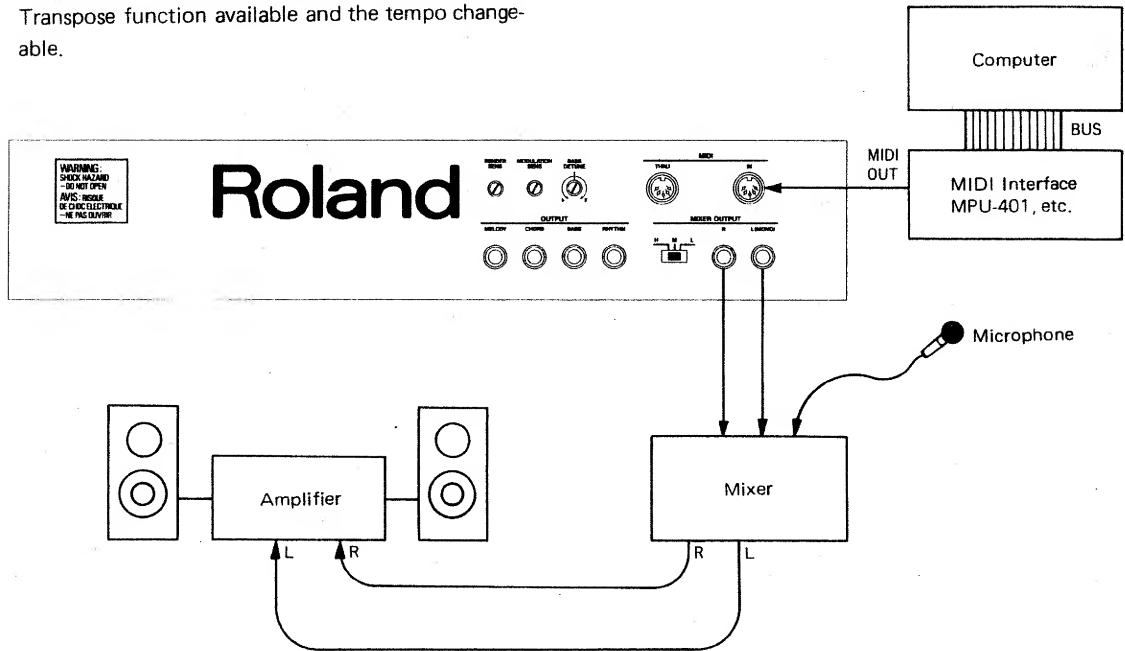

5 SPECIFICATIONS

MKS-7: Sound Module

Preset

- Melody: } 100 Tone Colors
- Chord: }
- Bass: 20 Tone Colors
- Rhythm: 11 Drum Voices
 - Bass Drum
 - Snare Drum
 - Hi-Tom
 - Mid-Tom
 - Low-Tom
 - Open/Closed Hi-Hat's
 - Hand Clap
 - Rim Shot
 - Ride Cymbal
 - Clash Cymbal

Front Panel

- Tune Knob
- Volume Knob
- Rhythm Level Knob
- Bass Level Knob
- Chord Level Knob
- Melody Level Knob
- Dynamics Sens Knob
- Display Window
- Rhythm Button
- Bass Button
- Chord Button
- Melody Button
- Sound Source Selector Buttons
(Bass, Chord, Melody)
- Number Button (0 to 9)
- MIDI Channel Button
- Transpose Button
- Headphones Jack
- Power Switch

Rear Panel

- Pitch Bender Sens Knob
- Modulation Sens Knob
- Bass Detune Knob
- Output Level Switch
- MIDI IN Connector
- MIDI THRU Connector
- Melody Output Jack
- Chord Output Jack
- Bass Output Jack
- Rhythm Output Jack
- Mix Output Jacks (L, R)

Consumption 25W

Dimensions Black:
482(W) x 400(D) x 88(H) mm
18-15/16" x 15-3/4" x 3-7/16"
Ivory:
430(W) x 400(D) x 88(H) mm
16-15/16" x 15-3/4" x 3-7/16"

Weights Black:
7 kg / 15 lb 7 oz
Ivory:
7.5 kg / 16 lb 9 oz

Accessories MIDI Cable (1m) x 1
Connection Cord (2.5m) x 2

OPTIONS

- **Carrying Case** TB-2U
- **MIDI SYNC Cable** MSC-25/50

Sound module

MODEL **MKS-7** MIDI Implementation Chart

Melody Block

Function.....		Transmitted	Recognized	Remarks
Basic Channel	Default	×	1	
	Changed	×	1 - 16	
Mode	Default	×	Mode 3	
	Messages	×	×	
	Altered	*****	×	
Note Number	True voice	×	0 - 127	
		*****	24 - 108	
Velocity	Note ON	×	○	
	Note OFF	×	×	
After Touch	Key's	×	×	
	Ch's	×	×	
Pitch Bender		×	○	
Control Change	1	×	○	Modulation Hold
	64	×	○	
Prog Change	True #	×	○ (0-127)	
		*****	0 - 99	
System Exclusive		×	○	Tone parameters
System Common	Song Pos	×	×	
	Song Sel	×	×	
	Tune	×	×	
System Real Time	Clock	×	×	
	Commands	×	×	
Aux Messages	Local ON / OFF	×	×	(123-127)
	All Notes OFF	×	○	
Messages	Active Sense	×	○	
	Reset	×	×	
Notes		When the CHORD block is in 6 voice mode, the MELODY block cannot sound.		

Mode 1 : OMNI ON, POLY
 Mode 3 : OMNI OFF, POLY

Mode 2 : OMNI ON, MONO
 Mode 4 : OMNI OFF, MONO

○ : Yes
 × : No

Chord Block

Function.....		Transmitted	Recognized	Remarks
Basic Channel	Default Changed	× ×	3 1 - 16	
Mode	Default Messages Altered	× × *****	Mode 3 × ×	
Note Number	True voice	× *****	0 - 127 24 - 108	
Velocity	Note ON Note OFF	× ×	○ ×	
After Touch	Key's Ch's	× ×	× ×	
Pitch Bender		×	○	
Control Change	1 64 121	× × ×	○ ○ ○	Modulation Hold Voice select (6/4 voices)
Prog Change	True #	× *****	○ (0-127) 0-99	
System Exclusive		×	○	Tone parameters
System Common	Song Pos Song Sel Tune	× × ×	× × ×	
System Real Time	Clock Commands	× ×	× ×	
Aux Messages	Local ON OFF All Notes OFF Active Sense Reset	× × × ×	× ○ (123-127) ○ ×	
Notes				

Mode 1 : OMNI ON, POLY
Mode 3 : OMNI OFF, POLY

Mode 2 : OMNI ON, MONO
Mode 4 : OMNI OFF, MONO

○ : Yes
× : No

Bass Block

Function.....		Transmitted	Recognized	Remarks
Basic Channel	Default Changed	× ×	2 1 - 16	
Mode	Default Messages Altered	× × *****	Mode 4 × ×	
Note Number	True voice	× *****	0 - 127 31 - 96	The actual keys are 1 octave lower.
Velocity	Note ON Note OFF	× ×	○ ×	
After Touch	Key's Ch's	× ×	× ×	
Pitch Bender		×	×	
Control Change				
Prog Change	True #	× *****	○ (0-127) 0-19	
System Exclusive		×	○	Tone parameters
System Common	Song Pos Song Sel Tune	× × ×	× × ×	
System Real Time	Clock Commands	× ×	× ×	
Aux Messages	Local ON OFF All Notes OFF Active Sense Reset	× × × ×	× ○ (123-127) ○ ×	
Notes				

Mode 1 : OMNI ON, POLY
Mode 3 : OMNI OFF, POLY

Mode 2 : OMNI ON, MONO
Mode 4 : OMNI OFF, MONO

○ : Yes
× : No

Rhythm Block

Function.....		Transmitted	Recognized	Remarks
Basic Channel	Default Changed	× ×	10 1 - 16	
Mode	Default Messages Altered	× × *****	Mode 3 × ×	
Note Number	True voice	× *****	35 - 51 35 - 51	
Velocity	Note ON Note OFF	× ×	 ×	
After Touch	Key's Ch's	× ×	× ×	
Pitch Bender		×	×	
Control Change				
Prog Change	True #	× *****	×	
System Exclusive		×	×	
System Common	Song Pos Song Sel Tune	× × ×	× × ×	
System Real Time	Clock Commands	× ×	× ×	
Aux Messages	Local ON OFF All Notes OFF Active Sense Reset	× × × ×	× × × ×	
Notes	Note # to instruments assignment. 35,36 - Bass Dr 48,50 - Hi Tom 46 - Opn HH 38,40 - Snr Dr 37 - Rim Sht 49 - Crsh Cym 41,43 - Low Tom 39 - Hnd Clp 51 - Ride Cym 45,47 - Mid Tom 42,44 - Cls HH			

Mode 1 : OMNI ON, POLY
 Mode 3 : OMNI OFF, POLY

Mode 2 : OMNI ON, MONO
 Mode 4 : OMNI OFF, MONO

○ : Yes
 × : No

