

AKAI SERVICE MANUAL



MIDI PRODUCTION CENTER

MODEL **MPC2000**

★ SAFETY INSTRUCTIONS

PRECAUTIONS DURING SERVICING

1. Parts identified by the Δ (*) symbol are critical for safety. Replace them only with the parts number specified.
2. In addition to safety, other parts and assemblies are specified for conformance with such regulations as those applying to spurious radiation. These must also be replaced only with the specified replacements.
Examples: RF converters, tuner units, antenna selector switches, RF cables, noise blocking capacitors, noise blocking filters, etc.
3. Use specified internal wiring. Note especially:
 - 1) Wires covered with PVC tubing
 - 2) Double insulated wires
 - 3) High voltage leads
4. Use specified insulating materials for hazardous live parts.
Note especially:
 - 1) Insulation Tape
 - 2) PVC tubing
 - 3) Spacers (insulating barriers)
 - 4) Insulation sheets for transistors
 - 5) Plastic screws for fixing micro switches
5. When replacing AC primary side components (transformers, power cords, noise blocking capacitors, etc.), wrap the ends of the wires securely around the terminals before soldering.

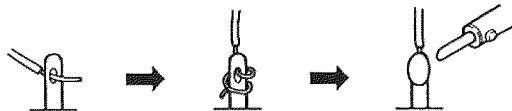

6. Make sure that wires do not contact heat producing parts (heat sinks, oxide metal film resistors, fusible resistors, etc.).
7. Check that replaced wires do not contact sharp edged or pointed parts.
8. Also check areas surrounding repaired locations.
9. Make sure that foreign objects (screws, solder droplets, etc.) do not remain inside the set.

SAFETY CHECK AFTER SERVICING

After servicing, make measurements of leakage-current or resistance in order to determine that exposed parts are acceptably insulated from the supply circuit.

The leakage-current measurement should be done between accessible metal parts (such as chassis, ground terminal, microphone jacks, signal input/output connectors, etc.) and the earth ground through a resistor of 1500 ohms paralleled with a 0.15 μ F capacitor, under the unit's normal working conditions. The leakage-current should be less than 0.5 mA rms AC.

The resistance measurement should be done between accessible exposed metal parts and power cord plug prongs with the power switch (if included) "ON". The resistance should be more than 2.2 M ohms.

★ INFORMATIONS

SYMBOLS FOR PRIMARY DESTINATION

Unit destinations are indicated with letters as shown below.

Symbols	Principal Destinations
A	U.S.A
B	U.K
C	Canada
E	Europe (except U.K)
J	Japan
S	Australia
V	Germany
U	Universal Area
Y*	Custom version

★ SPECIFICATIONS

<p>Sound generator</p> <p>Sampling rate 44.1 kHz (20 Hz to 20 kHz)</p> <p>Sampling capacity 2 MB standard (expandable to 32 MB) (21.9 second/monaural or 10.9 second/stereo)</p> <p>Data format 16 bit linear</p> <p>Dynamic filtering 12 dB/oct dynamic resonant low pass filter per voice</p> <p>Maximum sounds in memory 128</p> <p>Number of sound program 24</p> <p>Sound assignments per program 64</p> <p>Simultaneous voices 32</p> <p>Sequencer</p> <p>Maximum notes 100,000</p> <p>Resolution 96 parts per 1/4-note (ppq)</p> <p>Sequence 99</p> <p>Tracks per sequence 64</p> <p>MIDI output channels 32 (16 channels x 2 output ports)</p> <p>Song mode 20 songs, 250 steps per song</p> <p>Drum pads 16 (with velocity & pressure sensitive)</p> <p>Drum pad banks 4</p> <p>Sync mode MIDI clock with S.P.P., MTC, MMC, SMPTE (option). SMPTE frame rates supported are 24, 25, 30 and 30 drops (29.97)</p> <p>Rear panel IN/OUT</p> <p>Record input 1/4 inch stereo phone jack x 2, balanced</p> <p>Sensitivity -40 dBu/39 kohms (REC VR max.)</p> <p>Maximum input level +10 dBu</p> <p>Digital sampling input RCA-pin jack x1, S/PDIF (option)</p> <p>Digital master output RCA-pin jack x1, S/PDIF (option)</p>	<p>Stereo output 1/4 inch stereo phone jack x 2, unbalanced</p> <p>Output level +11 dBu/100 ohms level</p> <p>Maximum output level +17 dBu/100 ohms</p> <p>Assignable mix out (option) 1/4 inch stereo phone jack x 8, unbalanced</p> <p>Output level +11 dBu/100 ohms</p> <p>Maximum output level +17 dBu/100 ohms</p> <p>Headphone output 1/4 inch stereo phone jack x 1, Output level 200 mW/32 ohms</p> <p>MIDI inputs 5 pin-DIN x 2 (mergeable)</p> <p>MIDI outputs 5 pin-DIN x 2 (independent)</p> <p>SCSI port 1 (25-pin D-sub connector)</p> <p>General</p> <p>Display 248 x 64 dots graphic LCD</p> <p>Disk drive 3.5 inch 2HD/2DD</p> <p>Expansion</p> <p>memory slots 2 (72 pin SIMM, 70 ns)</p> <p>Dimensions 405 (W) x 126 (H) x 328 (D) mm</p> <p>Weight 6.3 kg</p> <p>Power requirements AC 100 V, 50/60 Hz for Japan AC 120 V, 60 Hz for U.S.A and Canada AC 220-240 V, 50 Hz for Europe</p> <p>Power consumption 23 W 13 W (without optional board)</p> <p>Optional boards</p> <p>EB16 Multi effect processor board</p> <p>FMX008M 8 MB flash ROM board</p> <p>IB-M208P 8 PARA out & digital I/O board</p> <p>IB-M20T SMPTE board</p> <p>Standard accessories</p> <p>Power cable 1</p> <p>Floppy disk 1 (OS disk) 3 (Sound library disk)</p> <p>Operator's manual 1</p>
---	--

0 dBu=0.775 VRMS

* For improvement purposes, specifications and design are subject to change without notice.

This document was cleaned, restored and made available as free download by synfo.nl

I. DISASSEMBLY

In case of trouble, etc., necessitating dismantling, please dismantle in the order shown in the illustrations. Reassemble in the reverse order.

1. Remove the 4 screws on both the left and right sides and 3 screws on the back.

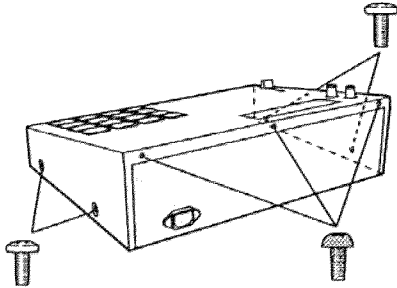

3. Remove the 3 screws which secure the UPPER PANEL. Next, extract the NOTE VARIATION knob and remove the UPPER PANEL.

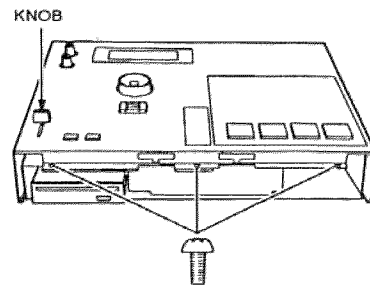

2. Remove the 3 screws on the bottom. Remove the FRONT PANEL by pulling it in the forward direction.

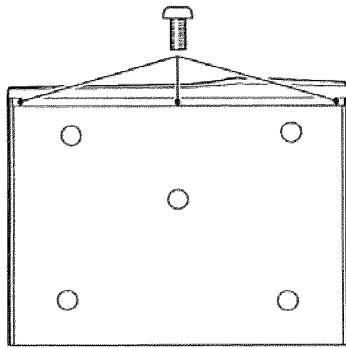

4. Remove the 4 screws on both the left and right sides and 2 screws on the sub chassis.

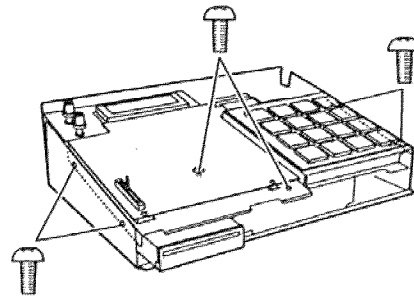

Disconnect the P2 connector on the CPU PCB then remove the sub chassis with the OPERATION PCB and PAD block attached.

II. PRINCIPAL PARTS LOCATION

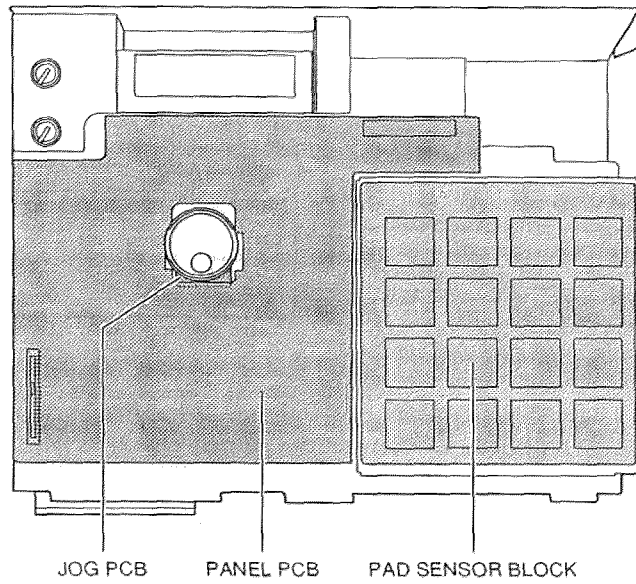

Fig. 2-1 Upper view (1)

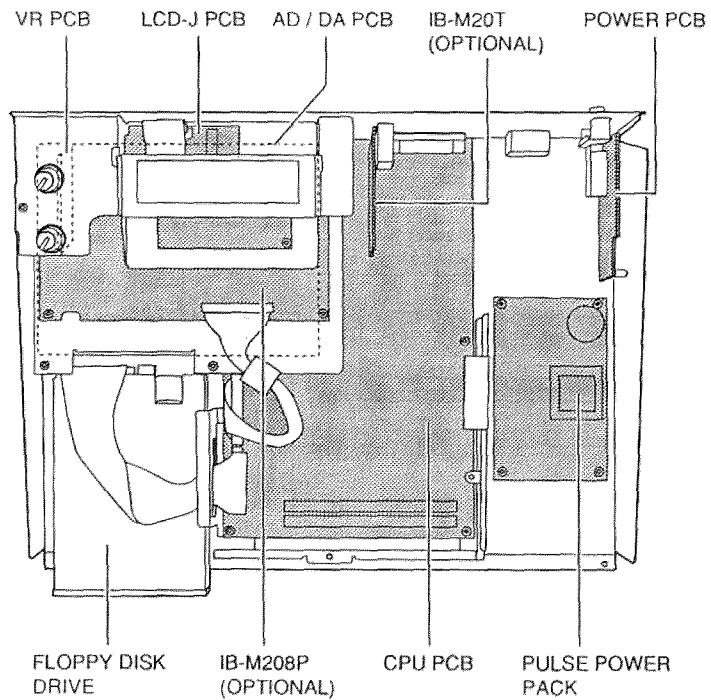

Fig. 2-2 Upper view (2)

III. SUPPLEMENTARY INFORMATION

TEST MODE

※ This test mode is used for the inspection of the unit. To check the unit, proceed as follows.

Engaging the test mode.

- 1) Turn the power on and insert the OS disk according to the LCD indication. After the system is bootup, press the "MIXER (7)" button while pressing the "SHIFT" button.
- 2) Press the "OPEN WINDOW" button.
- 3) Press the "0" button while pressing the "SHIFT" button. The "flash file memory test" screen appears when the test mode is engaged.
- 4) To disengage the test mode, press the "MAIN SCREEN" button or turn the power of the unit off.

NOTE: Only the [WAVE MEMORY TEST] and [FLASH FILE MEMORY TEST] modes can be proceed sequentially.

Once you engage the [PAD TEST] [REC OUT (8 PARA)] or [SMPTE TEST] mode in the test mode, it is not possible to go to the other test mode directly. In this case, press the "MAIN SCREEN" button and re-engage the test mode again to go to the other test modes.

※ The test mode may be different according to the version of the software.

3-1. Wave memory test

- 1) Engage the test mode and press the "F1" button. The following messages will be displayed.

NOTE: All wave memory (DRAM) will be lost when the "F1" button is pressed.

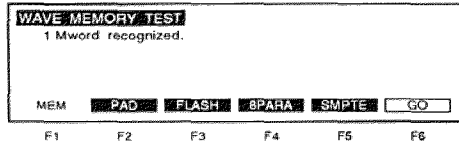

- 2) Press the "F6" (GO) button. The following messages will be displayed after the display stops incrementing.

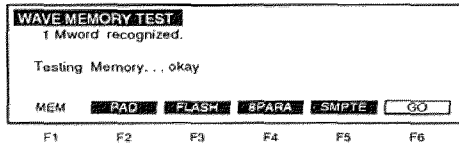

This means the function of the unit is operating properly.

3-2. Pad test

- 1) Engage the test mode and press the "F2" button. The following messages will be displayed.

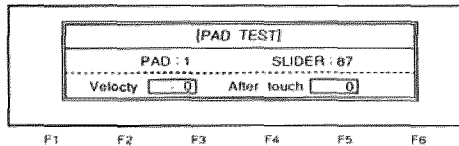

- 2) Press any of the 16 pad buttons. The pad number that you pressed will be shown in the display as well as the velocity and after touch conditions are displayed momentarily.

3-3. Flash file memory test

- 1) Engage the test mode and press the "F3" button. The following messages will be displayed.

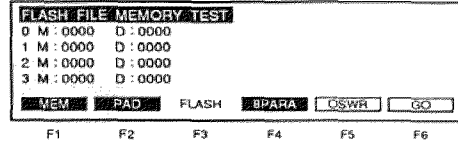

- 2) Press the "F6" (GO) button. The following messages will be displayed if the flash memory is not installed.

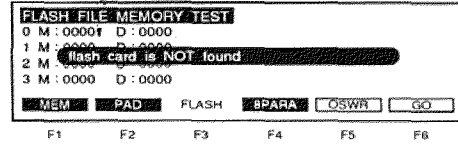

NOTE: All flash file memory (F-ROM) will be lost when this memory test is performed.

3-4. REC out (8PARA)

- 1) Engage the test mode and press the "F4" button. The following messages will be displayed.

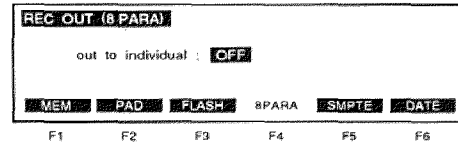

- 2) If the IB-M208P (optional 8PARA/ DIO PCB) is connected, "out to individual:" turns on when the "DATA" knob is turned.

3-5. SMPTE test

- 1) Engage the test mode and press the "F1" button then press the "F5" button. The following messages will be displayed.

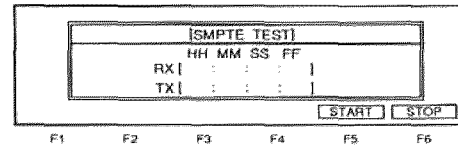

- 2) Press the "F5" (START) button if the IB-M20T (optional SMPTE PCB) is connected. TX starts incrementing and count up the time until the F6 (STOP) button is pressed.

IV. PARTS LIST

ATTENTION

1. When placing an order for parts, be sure to list the Part No., Model No. and the description of each part. Otherwise, the non-delivery of the part or the delivery of a wrong part may result.
2. Please make sure that Part No. is correct when ordering. If not, a part different from the one you ordered may be delivered.
3. Since the parts shown in Parts List or Preliminary Service Manual may have been the subject of changes, please use this Parts List for all future reference.

HOW TO USE THIS PARTS LIST

1. This Parts List lists those parts which are considered necessary for repairs. Other common parts, such as resistors and capacitors, are listed in the "Common List for Service Parts" from which these parts should be selected and stocked.
2. The Recommended Spare Parts List shows those parts in the Parts List which are considered particularly important for service.
3. Parts not shown in the Parts List and "Common List for Service Parts" will not in principle be supplied.
4. How to read the Parts List.

a) Mechanism Block

2. HEAD BASE BLOCK

Ref. No.	Part. No.	Description
1	BH-T2023A320A	HEAD BASE BLOCK
2	HP-H2206A010A	HEAD R/P PR4-8FU C
3	ZS-477876	PAN20x03STL CMT
4	ZS-536488	BID20x08STL CMT
5	ZG-402895	SP CS ANGLE ADJUST

SP (Service Parts) Classification

This number corresponds with the individual parts index number in the figure.

b) PC Board

2. MAIN PC BOARD

Ref. No.	Part. No.	Description
IC1	EI-324536	IC HD14049BP
IC2	EI-336801	IC MB8841-564M
C1A	EC-338399	C MMY V 223M 250AC [U,E,B,S]
C1B	EC-350949	C MMY V 223M 250DC [J]
C1C	EC-338397	C MMY V 223M 125AC [C,A]
X1	EI-318384	OSC XTAL NC-18C

Symbols for primary destination

[A] : AAL (U.S.A) [S] : SAA (Australia)
 [B] : BEAB (England)[U] : U/T (Universal Area)
 [C] : CSA (Canada)
 [E] : CEE (Europe) [V] : VDE (Germany)
 [J] : JPN (Japan) [Y] : Custom

SP (Service Parts) Classification

These reference symbols correspond with component symbols in the Schematic Diagrams.

The available PC Board Blocks are listed separately.

5. When Part No. is known, Parts Index at end of Parts List can be used to locate where that part is shown in Parts List by its Reference No. listed at right of Part No.

WARNING

⚠ INDICATES SAFETY CRITICAL COMPONENTS. FOR CONTINUED SAFETY, REPLACE SAFETY CRITICAL COMPONENTS ONLY WITH MANUFACTURER'S RECOMMENDED PARTS.

AVERTISSEMENT

⚠ IL INDIQUE LES COMPOSANTS CRITIQUES DE SÉCURITÉ. POUR MAINTENIR LE DEGRÉ DE SÉCURITÉ DE L'APPAREIL, NE REMPLACER QUE DES PIÈCES RECOMMANDÉES PAR LE FABRICANT.

1. RECOMMENDED SPARE PARTS

We suggest you to stock the following Recommended Spare Part items listed below since they can cover most of the routine service.

Ref. No.	Part No.	Description
1	BB-810498J	FDD FD-235HF-7549
2	ED-388539J	D LED GL-3HD43
3	ED-810393J	D LED GL-3KG8
4	ED-428162N	D SCHOTTKY 1S30-E T26
5	ED-388934J	D SILICON DS135E-FB2 F12 100/1
6	ED-344280	D SILICON H GMA-01-FY2 F05
7	ED-412105N	D ZENER H HZS581 T26
8	Δ EF-346890	FUSE ICP-F15 50V 0.6A
9	Δ EF-376821	FUSE ICP-N15 50V 0.6A
10	Δ EF-373142	FUSE ICP-N25 50V 1.0A
11	Δ EF-373143	FUSE ICP-N38 50V 1.5A
12	EI-810412J	ICAKS340-V5
13	EI-429988J	ICAV9173-01-CN8 T
14	EI-410414J1	IC CS8402A-CP
15	EI-432815J	IC E28F016SA-100
16	EI-810380J	IC HD74AC09FP
17	EI-430936J	IC HD74AC04FP
18	EI-396536J	IC HD74AC138P
19	EI-430943J	IC HD74AC74FP
20	EI-387934J	IC HD74HC04P
21	EI-394832J	IC HD74HC123AP
22	EI-386289J	IC HD74HC138P
23	EI-393895J	IC HD74HC154P
24	EI-810386J	IC HD74HC174FP
25	EI-388707J	IC HD74HC244P
26	EI-810382J	IC HD74HC259FP
27	EI-810268J	IC HD74HC273FP
28	EI-401217J	IC HD74HC32FP
29	EI-810383J	IC HD74HC4060FP
30	EI-388567J	IC HD74HC573P
31	EI-810269J	IC HD74HC595FP
32	EI-393696J	IC HD74HC86P
33	EI-810385J	IC HM5118160ALTT-7
34	EI-810153J	IC HM51269CLTT-7
35	EI-430810J	IC CS2008V
36	EI-413120J	IC L7A1045 L6028 DSP-A
37	EI-810047J	IC MB89352A-PFQ OFTY
38	EI-401213J	IC MB89371A-PF-G-BND QF
39	EI-810328J	IC MC74AC257M
40	EI-810646J	IC MC74HC04AN
41	EI-430680J	IC M51957AL
42	EI-430681J	IC M51958AL
43	EI-353227	IC M5216L
44	EI-393325N	IC M5218AP
45	EI-348785	IC M5220L
46	EI-360043	IC M5220P
47	EI-377047	IC M5223FP
48	EI-362587J1	IC M5298AL
49	EI-377191	IC NJM5532D-D
50	EI-810613J	IC PALCE16V8Q-15PC L4013C
51	EI-810379J	IC PALCE20V8Q-15PC L4013A
52	EI-810384J	IC PALCE20V8Q-15PC L4013B
53	EI-430673J	IC PALCE20V8Q-15PC L6039A
54	EI-412279J1	IC PCM69AP-4
55	EI-410389J	IC PQ30RV1
56	EI-376741J1	IC TC74HC244AF
57	EI-381290J1	IC TC74HC245AF
58	EI-377101	IC UPC7805HF
59	EI-430684J	IC UPD70236AGD-16-5BB
60	EI-396531J	IC UPD72068GF-3B9
61	EI-406572J	IC UPD78C10AGQ-36
62	EI-379997J	ICYM3623B
63	EI-354123	OSC CE CSA120MTZ 12.000000MHZ
64	EI-414859J	OSC X'TALAT-51 11.289600MHZ
65	EI-374176	OSC X'TALAT-51 16.9344MHZ
66	EI-396541J	OSC X'TAL HC-49U 32.000000MHZ
67	EJ-357159	PHONE J 2P HJ0520-110 W/NUT
68	EJ-354105	PHONE J 2P HJ0520-110 6.3
69	EJ-810705J	PHONE J 3P HJ0544-010W/N.W6.3

Ref. No.	Part No.	Description
70	EJ-810706J	PHONE J 3P HJ0544-110W/N.W6.3
71	EJ-810624J	PHONE J 3P HTJ-06411D 6.3
72	EQ-345990N	COIL FIX 1 EL0606RA T05 470J
73	EQ-414952J	TRANS PULSE CIT0705D-35101
74	EQ-348929	RELAY SIG G5A-237P 2TR 12V
75	ES-403377J	SW ROTARY ENCODER SRGPHJ
76	ES-411887N	SW TACT EVQ PAE 05R
77	ES-415015J	SW TACT SKQEAD
78	ET-430926J	DETECTOR PC400
79	ET-366763N	TR DTA114ES T05
80	ET-386938N	TR DTC123ES T05
81	ET-349593	TR 2SA1348 F05
82	ET-370013	TR 2SA874 Q,R
83	EV-810416J	VR ROTARY RK0971220 L25 B103X2
84	EV-810417J	VR ROTARY RK0971220 L25 C500X2
85	EV-810633J	VR SLIDE RS45112 L15 B103X2

2. P.C. BOARD BLOCK

Ref. No.	Part No.	Description
1	BA-L4013A020	PC CPU BLK
2	BA-L4013A030	PC(8) MULTI BLK
3	BA-L4013A040	PC(8) ADA BLK

PC (#) ADA BLK CONSISTS OF FOLLOWING P.C. BOARDS.

- ADA P.C. BOARD
- VR P.C. BOARD
- LCD-J P.C. BOARD

PC (#) MULTI BLK CONSISTS OF FOLLOWING P.C. BOARDS.

- PANEL P.C. BOARD
- JOG P.C. BOARD
- POWER P.C. BOARD

3. CPU P.C. BOARD

Ref. No.	Part No.	Description
D1	ED-344280	D SILICON H GMA-01-FY2 F05
D2	ED-428162N	D SCHOTTKY 1S30-E T26
D3	ED-344280	D SILICON H GMA-01-FY2 F05
D4	ED-388934J	D SILICON DS135E-FB2 F12 100/1
FL1	EH-410420J	FILTER EMI DSS306-93B101MT05
FL2	EH-410420J	FILTER EMI DSS306-93B101MT05
FL3	EH-410420J	FILTER EMI DSS306-93B101MT05
FL4	EH-410420J	FILTER EMI DSS306-93B101MT05
FL5	EH-410420J	FILTER EMI DSS306-93B101MT05
FL6	EH-410420J	FILTER EMI DSS306-93B101MT05
FL7	EH-410420J	FILTER EMI DSS306-93B101MT05
FL8	EH-410420J	FILTER EMI DSS306-93B101MT05
FL11	EH-410420J	FILTER EMI DSS306-93B101MT05
FL12	EH-413150J	FILTER EMI BL03RN2-R62T4 T05
FL13	EH-413150J	FILTER EMI BL03RN2-R62T4 T05
FL14	EH-413150J	FILTER EMI BL03RN2-R62T4 T05
FL15	EH-410420J	FILTER EMI DSS306-93B101MT05
FL16	EH-364254	FERRITE BEAD BL02RN2-R62
FL17	EH-413150J	FILTER EMI BL03RN2-R62T4 T05
FL18	EH-413150J	FILTER EMI BL03RN2-R62T4 T05
FL19	EH-413150J	FILTER EMI BL03RN2-R62T4 T05
FL20	EH-413150J	FILTER EMI BL03RN2-R62T4 T05
FL21	EH-413150J	FILTER EMI BL03RN2-R62T4 T05
FL22	EH-413150J	FILTER EMI BL03RN2-R62T4 T05
FL23	EH-413150J	FILTER EMI BL03RN2-R62T4 T05
FL24	EH-413150J	FILTER EMI BL03RN2-R62T4 T05
FL25	EH-413150J	FILTER EMI BL03RN2-R62T4 T05
FL26	EH-413150J	FILTER EMI BL03RN2-R62T4 T05
FL27	EH-413150J	FILTER EMI BL03RN2-R62T4 T05
FL28	EH-413150J	FILTER EMI BL03RN2-R62T4 T05

PARTS LIST

Ref. No.	Part No.	Description
FL29	EH-413150J	FILTER EMI BL03RN2-R62T4 T05
FL30	EH-413150J	FILTER EMI BL03RN2-R62T4 T05
FS1	Δ EF-373142	FUSE ICP-N25 50V 1.0A
IB1	EH-357538	COMP R RKC1/8B5 103J
IB2	EH-384817J	COMP R RKC1/8B8 102J
IB3	EH-408860J	COMP R RKC1/8B9 111J
IB4	EH-408860J	COMP R RKC1/8B9 111J
IB5	EH-810378J	COMP R RGS10L503G 503G
IC1	EI-430684J	IC UPD70236AGD-16-5BB
IC2	EI-430680J	IC M51957AL
IC3	EI-381290J1	IC TC74HC245AF
IC4	EI-810379J	IC PALCE20V8Q-15PC L4013A
IC5	EI-810328J	IC MC74AC257M
IC6	EI-810328J	IC MC74AC257M
IC7	EI-810380J	IC HD74AC00FF
IC8	EI-401217J	IC HD74HC32FP
IC9	EI-810153J	IC HM514260CLTT-7
IC10	EI-810153J	IC HM514260CLTT-7
IC11	EI-393695J	IC HD74HC154P
IC12-A	EI-810381J	ICAM27C256-150DC MPC2000V1.00 [PROGRAM ROM]
IC12-B	EI-397343J	ICAM27C256x150DC [BLANK ROM]
IC13	EI-401213J	IC MB89371A-PF-G-BND OF
IC14	EI-401217J	IC HD74HC32FP
IC15	EI-810382J	IC HD74HC259FP
IC16	EI-430943J	IC HD74AC74FP
IC17	EI-396531J	IC UPD72068GF-3B9
IC18	EI-810047J	IC MB89352A-PFQ OFTY
IC19	EI-410389J	IC PC30RV1
IC20	EI-413120J	IC L7A1045 L6028 DSP-A
IC21	EI-429988J	IC AV9173-01-CN8 T
IC22	EI-376741J1	IC TC74HC244AF
IC23	EI-810383J	IC HD74HC4060FP
IC24	EI-430673J	IC PALCE20V8Q-15PC L6039A
IC25	EI-810613J	IC PALCE16V8Q-15PC L4013C
IC26	EI-810268J	IC HD74HC273FP
IC27	EI-810269J	IC HD74HC595FP
IC28	EI-810269J	IC HD74HC595FP
IC29	EI-430943J	IC HD74AC74FP
IC30	EI-810384J	IC PALCE20V8Q-15PC L4013B
IC31	EI-810385J	IC HM5118180ALTT-7
IC32	EI-377047	IC M5223FP
IC33	EI-810382J	IC HD74HC259FP
IC34	EI-810386J	IC HD74HC174FP
IC35	EI-430936J	IC HD74AC04FP
J1	EJ-430956J	DIN J YKF51-5058 2X5P
J2	EJ-428182J	SOCKET DBLC-J25SAF-20L9 25P
J3	EJ-430956J	DIN J YKF51-5058 2X5P
J4	EJ-430687J	SOCKET 128A-044S2A-S14N 44P
J5	EJ-424423J	SOCKET 6-176438-7 72P
J6	EJ-424423J	SOCKET 6-176438-7 72P
J7	EJ-810388J	SOCKET 225D-10018E2-2314 18P
PH1	ET-430926J	DETECTOR PC400
PH2	ET-430926J	DETECTOR PC400
P2	EJ-810389J	PLUG RA-H201TD-1190 20P
P3	EJ-430689J	PLUG 128A-060P3C-S14N 60P
P5	EJ-429927J	PLUG 302-20GSB 20P
P6	EJ-429927J	PLUG 302-20GSB 20P
P7	EJ-429929J	PLUG 302-34GSB 34P
W101	EW-810390J	WIRE ASSY L4013 W101 34P
X1	EI-396541J	OSC X TAL HC-49/U 32.000000MHZ
X2	EI-414959J	OSC X TALAT-51 11.289600MHZ

4. ADA P.C. BOARD

Ref. No.	Part No.	Description
D5	ED-344280	D SILICON H GMA-01-FY2 F05
D6	ED-389934J	D SILICON DS135E-FB2 F12 100/1
FL4	EH-410426J	FILTER EMI DSS306-93B101MT05
FL5	EH-410426J	FILTER EMI DSS306-93B101MT05
FL6	EH-410420J	FILTER EMI DSS306-93B101MT05
FR1	ER-200746	R FUSE H ERD2FC 1/4W 1000G
FR2	ER-200746	R FUSE H ERD2FC 1/4W 1000G
FR3	ER-403339N	R FUSE V T05 ERD2FCV 1/4W10R0G

Ref. No.	Part No.	Description
FS1	Δ EF-346880	FUSE ICP-F15 50V 0.6A
FS2	Δ EF-346880	FUSE ICP-F15 50V 0.6A
IC1	EI-377191	IC NJM5532D-D
IC2	EI-377191	IC NJM5532D-D
IC3	EI-360043	IC M5220P
IC4	EI-360043	IC M5220P
IC5	EI-810412J	ICAK5340-VS
IC6	EI-377101	IC UPC7805HF
IC8	EI-412279J1	IC PCM69AP-4
IC9	EI-377101	IC UPC7805HF
IC10	EI-360043	IC M5220P
IC11	EI-360043	IC M5220P
IC12	EI-393325N	IC M5218AP
IC13	EI-393325N	IC M5218AP
IC14	EI-353227	IC M5216L
IC15	EI-430681J	IC M51958AL
J201	EJ-810624J	PHONE J 3P HTJ-06411D 6.3
J202	EJ-810624J	PHONE J 3P HTJ-06411D 6.3
J203	EJ-354105	PHONE J 2P HLJ0520-110 6.3
J204	EJ-354105	PHONE J 2P HLJ0520-110 6.3
J205	EJ-810624J	PHONE J 3P HTJ-06411D 6.3
L1	EO-345990N	COIL FIX 1 EL0606RA T05 470J
RL1	EO-348929	RELAY SIG G5A-237P 2TR 12V
R67	ER-430691N	R OMF H S12 FS RSS1 1W 101J
R68	ER-430691N	R OMF H S12 FS RSS1 1W 101J
TR1	ET-366753N	TR DTA114EST05
W203	EW-810415J	WIRE ASSY L4013 W203 20P

5. VR P.C. BOARD

Ref. No.	Part No.	Description
VR201	EV-810416J	VR ROTARY RK0971220 L25 B103X2
VR202	EV-810417J	VR ROTARY RK0971220 L25 C503X2

6. LCD-J P.C. BOARD

Ref. No.	Part No.	Description
P3	EJ-810418J	SOCKET SLD19S-1 19P
W204	EW-810419J	WIRE ASSY L4013 W204 20P

7. PANEL P.C. BOARD

Ref. No.	Part No.	Description
D1	ED-810393J	D LED GL-3KG8
D2	ED-388539J	D LED GL-3HD43
D3	ED-388539J	D LED GL-3HD43
D4	ED-810393J	D LED GL-3KG8
D5	ED-388539J	D LED GL-3HD43
D6	ED-810393J	D LED GL-3KG8
D7	ED-810393J	D LED GL-3KG8
D8	ED-810393J	D LED GL-3KG8
D9	ED-810393J	D LED GL-3KG8
D10	ED-810393J	D LED GL-3KG8
D11	ED-810393J	D LED GL-3KG8
D12	ED-344280	D SILICON H GMA-01-FY2 F05
D13	ED-344280	D SILICON H GMA-01-FY2 F05
D14	ED-344280	D SILICON H GMA-01-FY2 F05
D15	ED-344280	D SILICON H GMA-01-FY2 F05
D16	ED-344280	D SILICON H GMA-01-FY2 F05
D17	ED-344280	D SILICON H GMA-01-FY2 F05
D18	ED-412105N	D ZENER H HZS5B1 T26
D19	ED-344280	D SILICON H GMA-01-FY2 F05
D20	ED-412105N	D ZENER H HZS5B1 T26
D21	ED-344280	D SILICON H GMA-01-FY2 F05
D22	ED-412105N	D ZENER H HZS5B1 T26
D23	ED-344280	D SILICON H GMA-01-FY2 F05
D24	ED-412105N	D ZENER H HZS5B1 T26
D25	ED-344280	D SILICON H GMA-01-FY2 F05
D26	ED-344280	D SILICON H GMA-01-FY2 F05
D27	ED-344280	D SILICON H GMA-01-FY2 F05

Ref. No.	Part No.	Description
D28	ED-344280	D SILICON H GMA-01-FY2 F05
D29	ED-344280	D SILICON H GMA-01-FY2 F05
D30	ED-344280	D SILICON H GMA-01-FY2 F05
D31	ED-344280	D SILICON H GMA-01-FY2 F05
D32	ED-344280	D SILICON H GMA-01-FY2 F05
D33	ED-344280	D SILICON H GMA-01-FY2 F05
D34	ED-344280	D SILICON H GMA-01-FY2 F05
D35	ED-344280	D SILICON H GMA-01-FY2 F05
D36	ED-344280	D SILICON H GMA-01-FY2 F05
D37	ED-344280	D SILICON H GMA-01-FY2 F05
D38	ED-344280	D SILICON H GMA-01-FY2 F05
D39	ED-344280	D SILICON H GMA-01-FY2 F05
D40	ED-344280	D SILICON H GMA-01-FY2 F05
D41	ED-344280	D SILICON H GMA-01-FY2 F05
IB1	EH-349374	COMP R RKC1/8B8 472J
IB2	EH-349374	COMP R RKC1/8B8 472J
IC1	EI-405672J	IC UPD78C10AGQ-36
IC2	EI-388567J	IC HD74HC138P
IC3	EI-388567J	IC HD74HC573P
IC4-A	EI-810630J	ICAM27C256 MPC2000 V1.0-OP [PROGRAM ROM]
IC4-B	EI-397343J	ICAM27C256-150DC [BLANK ROM]
IC5	EI-387934J	IC HD74HC04P
IC6	EI-362587J1	IC M5238AL
IC7	EI-362587J1	IC M5238AL
P905	EJ-379603	PLUG 20FR-ST
SW1	ES-411687N	SW TACT EVQ PAE 05R
SW2	ES-411687N	SW TACT EVQ PAE 05R
SW3	ES-411687N	SW TACT EVQ PAE 05R
SW4	ES-411687N	SW TACT EVQ PAE 05R
SW5	ES-411687N	SW TACT EVQ PAE 05R
SW6	ES-411687N	SW TACT EVQ PAE 05R
SW7	ES-411687N	SW TACT EVQ PAE 05R
SW8	ES-411687N	SW TACT EVQ PAE 05R
SW9	ES-411687N	SW TACT EVQ PAE 05R
SW10	ES-411687N	SW TACT EVQ PAE 05R
SW11	ES-411687N	SW TACT EVQ PAE 05R
SW12	ES-411687N	SW TACT EVQ PAE 05R
SW13	ES-411687N	SW TACT EVQ PAE 05R
SW14	ES-411687N	SW TACT EVQ PAE 05R
SW15	ES-411687N	SW TACT EVQ PAE 05R
SW16	ES-411687N	SW TACT EVQ PAE 05R
SW17	ES-411687N	SW TACT EVQ PAE 05R
SW18	ES-411687N	SW TACT EVQ PAE 05R
SW19	ES-411687N	SW TACT EVQ PAE 05R
SW20	ES-411687N	SW TACT EVQ PAE 05R
SW21	ES-411687N	SW TACT EVQ PAE 05R
SW22	ES-415015J	SW TACT SKQEAD
SW23	ES-411687N	SW TACT EVQ PAE 05R
SW24	ES-411687N	SW TACT EVQ PAE 05R
SW25	ES-411687N	SW TACT EVQ PAE 05R
SW26	ES-411687N	SW TACT EVQ PAE 05R
SW27	ES-411687N	SW TACT EVQ PAE 05R
SW28	ES-415015J	SW TACT SKQEAD
SW29	ES-415015J	SW TACT SKQEAD
SW30	ES-415015J	SW TACT SKQEAD
SW31	ES-415015J	SW TACT SKQEAD
SW32	ES-411687N	SW TACT EVQ PAE 05R
SW33	ES-411687N	SW TACT EVQ PAE 05R
SW34	ES-411687N	SW TACT EVQ PAE 05R
SW35	ES-411687N	SW TACT EVQ PAE 05R
SW36	ES-411687N	SW TACT EVQ PAE 05R
SW37	ES-411687N	SW TACT EVQ PAE 05R
SW38	ES-411687N	SW TACT EVQ PAE 05R
SW39	ES-411687N	SW TACT EVQ PAE 05R
SW40	ES-411687N	SW TACT EVQ PAE 05R
SW41	ES-415015J	SW TACT SKQEAD
VR1	EV-810633J	VR SLIDE RS45112 L15 B103X2
W304	EW-810396J	WIRE ASSY L4013 W304 20P
X1	EI-354123	OSC CE CSA120MTZ 12.000000MHZ

8. JOG P.C. BOARD

Ref. No.	Part No.	Description
SW302	ES-403377J	SW ROTARY ENCODER SRGPHJ

9. POWER P.C. BOARD

Ref. No.	Part No.	Description
C301	Δ.EC-427562J	C MMY V CUT MKP3362 103M 275AC
C302	Δ.EC-425606J	C MMY V CUT MMRC 683M 275AC
C307	Δ.EC-427562J	C MMY V CUT MKP3362 103M 275AC
FL301	Δ.EO-389172J	COIL LF LF-4N 502
SW301	Δ.ES-430685J1	SW PUSH SDDF3A 02-1

10. FINAL ASSEMBLY BLOCK

Ref. No.	Part No.	Description
1	SA-810344J	FOOT
2	ZS-379405N	BID30X06STL CMT (SG)
3	ZS-320906	ST BR30X06STL CMT
4	BB-810408J	FDD FD-235HF-7549
5	ZS-322570	ST BID40X08STL N13
6	ZS-376875	BT CTS30X08STL BNI
7	ZW-413267	N FRANGE 40STL CMT
8	Δ.BP-810446J	SW REGULATOR SNP-9541
9	Δ.EJ-358632J2	SOCKET INLET SOT-16 3P
10	ZS-428277J	PAN30X06STL CMT POLY WAVE
11	ZS-345272	ST BR30X06STL BNI
12	ZS-350934	PT BR30X06STL BNI
13	EM-810407J	IND LCD GMV24160AFTW
14	ZW-810347J	SPACER LCD
15	ZS-810640J	BT PAN17X05STL CMT PS3
16	BA-810408J	INVERSEUR 13585A-CFL-INV
17	ZW-810346J	PLASTIC SPACER
18	ZS-400878J	ST BR30X15STL CMT
19	SB-810525J	BUTTON POWER
20	SE-376331	PAD
21	BA-379695J1	PC PAD SENSOR
22	SB-429685J	BUTTON PUSH(B)
		[WHITE]
23	SB-810362J	BUTTON PUSH(B)-2
		[BLUE]
24	SB-430327J	BUTTON PUSH B(2)
		[RED]
25	SB-810359J	BUTTON PUSH B(3)
		[WHITE]
26	SB-810360J	BUTTON PUSH C-3
		[WHITE]
27	SB-413601J1	BUTTON CURSOR
28	SE-810673J	SPACER BUTTONPUSH A
29	SE-810674J	SPACER BUTTONPUSH B
30	SP-810424J	PANEL TOP MPC2000
31	ZS-331182	BT BID30X08STL BNI
32	SK-810361J	KNOB SLIDE (B)
33	SK-810363J	KNOB SHUTTLE(F)
34	SK-810364J	KNOB JOG(F)
35	SK-411144J	KNOB VOL PART(1)
		[WHITE]
36	SK-411147J	KNOB VOL PART(2)
		[RED]
37	BD-810348J	PANEL FRONT
38	ZS-348375	ST BR30X08STL CMT
39	ZS-322570	ST BID40X08STL N13
40	SE-810353J	LENS LED
41-A	Δ.EW-380905J	AC CORD 250S KP300 KS16A H B J
		[J]
41-B	Δ.EW-368420J1	AC CORD200SKP30KS16 BAC
		[A]
41-C	Δ.EW-410608J	AC CORD 250S KP4819D KS31A B E
		[E,V]
41-D	Δ.EW-419170J	AC CORD200S KP610 KS31A B
		[B]
42	Δ.EJ-405424J	PLUG ADAPTOR KPR-25
		[J]

NOTE :

Parts will not be supplied if they are not listed in the parts list, even if they appear on the assembling illustrations with reference No.

PARTS LIST

FINAL ASSEMBLY BLOCK

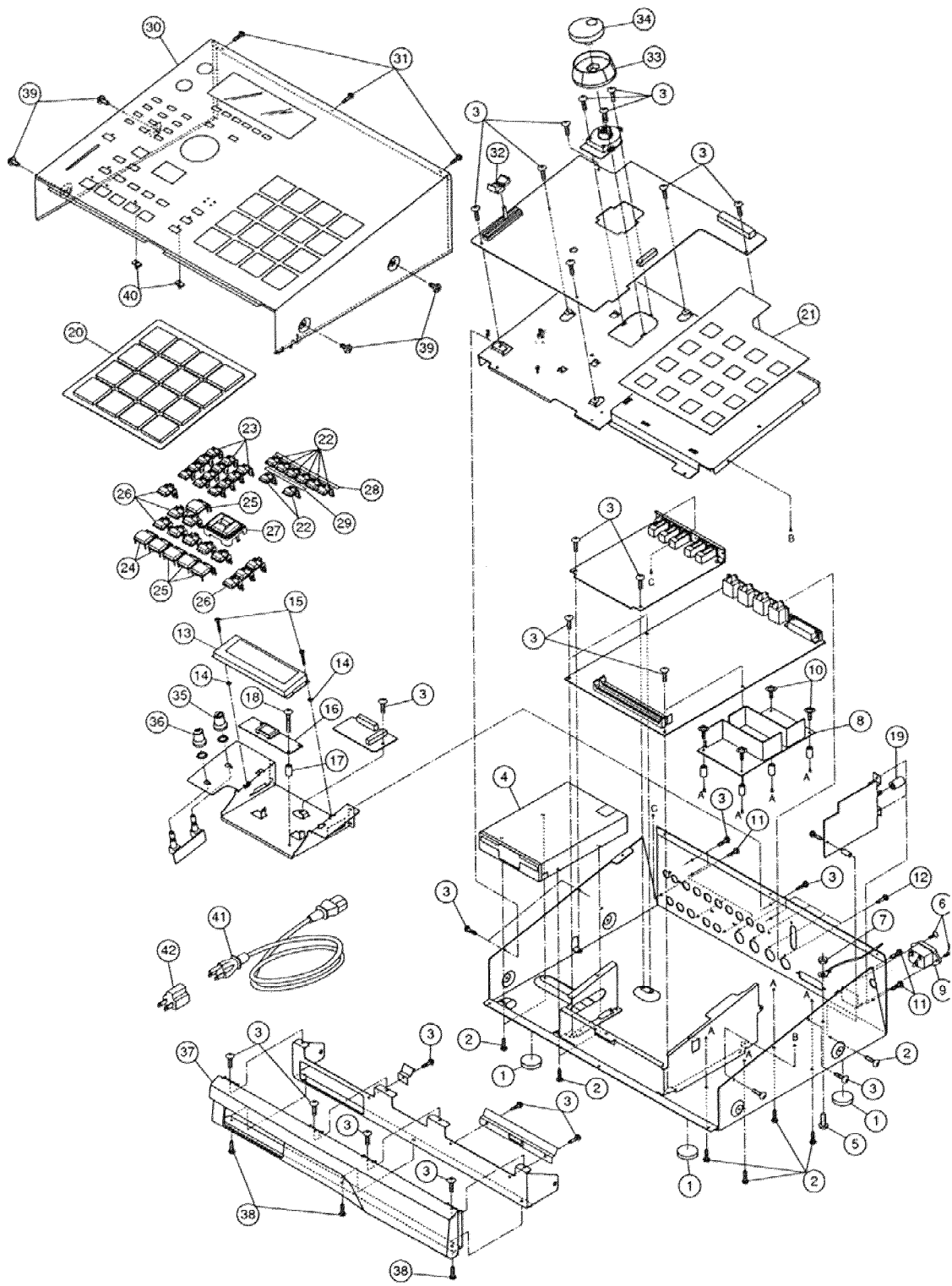

PARTS LIST

11. 8PARA/DIO (IB-M208P OPTIONAL P.C. BOARD)

Ref.No.	Part No.	Description
FL501	EH-410420J	FILTER EMI DSS306-93B101MT05
FL506	EH-410420J	FILTER EMI DSS306-93B101MT05
FL507	EH-410420J	FILTER EMI DSS306-93B101MT05
FL508	EH-410420J	FILTER EMI DSS306-93B101MT05
FL509	EH-410420J	FILTER EMI DSS306-93B101MT05
FL511	EH-404248J	FILTER EMI DSS310-54B 101M CUT
FL512	EH-404248J	FILTER EMI DSS310-54B 101M CUT
FSS01	Δ EF-376821	FUSE ICP-N15 50V 0.8A
FSS02	Δ EF-373143	FUSE ICP-N38 50V 1.5A
IC501	EI-388707J	IC HD74HC244P
IC502	EI-393696J	IC HD74HC86P
IC503	EI-412279J1	IC PCM69AP-4
IC504	EI-412279J1	IC PCM69AP-4
IC505	EI-412279J1	IC PCM69AP-4
IC506	EI-412279J1	IC PCM69AP-4
IC507	EI-348785	IC M5220L
IC508	EI-348785	IC M5220L
IC509	EI-348785	IC M5220L
IC510	EI-348785	IC M5220L
IC511	EI-348785	IC M5220L
IC512	EI-348785	IC M5220L
IC513	EI-348785	IC M5220L
IC514	EI-348785	IC M5220L
IC515	EI-393325N	IC M5218AP
IC516	EI-393325N	IC M5218AP
IC517	EI-393325N	IC M5218AP
IC518	EI-393325N	IC M5218AP
IC519	EI-379997J	IC YM3623B
IC521	EI-410414J1	IC CS8402A-CP
IC522	EI-377101	IC UPC7805HF
IC524	EI-810646J	IC MC74HC04AN
IC525	EI-394832J	IC HD74HC123AP
J501	EJ-357159	PHONE J 2P HLJ0520-110 W/NUT
J502	EJ-357159	PHONE J 2P HLJ0520-110 W/NUT
J503	EJ-357159	PHONE J 2P HLJ0520-110 W/NUT
J504	EJ-357159	PHONE J 2P HLJ0520-110 W/NUT
J505	EJ-357159	PHONE J 2P HLJ0520-110 W/NUT
J506	EJ-357159	PHONE J 2P HLJ0520-110 W/NUT
J507	EJ-357159	PHONE J 2P HLJ0520-110 W/NUT
J508	EJ-357159	PHONE J 2P HLJ0520-110 W/NUT
J509	EJ-430794J	PIN J YKC21-3045 2P
R565	ER-324480	R CB H S10 FS RDS 1/4W 470J
R566	ER-324480	R CB H S10 FS RDS 1/4W 470J
R567	ER-324480	R CB H S10 FS RDS 1/4W 470J
R568	ER-324480	R CB H S10 FS RDS 1/4W 470J
R569	ER-324480	R CB H S10 FS RDS 1/4W 470J
R570	ER-324480	R CB H S10 FS RDS 1/4W 470J
R571	ER-324480	R CB H S10 FS RDS 1/4W 470J
R572	ER-324480	R CB H S10 FS RDS 1/4W 470J
T501	EO-414952J	TRANS PULSE CIT0705D-35101
W501	EW-810423J	WIRE ASSY L4013 W401 34P
X501	EI-374176	OSC XTAL AT-51 16.9344MHZ
FL1	EH-810632J	FILTER EMI TFC-16- 8-16

12. SMPTE (IB-M20T OPTIONAL P.C. BOARD)

Ref.No.	Part No.	Description
D801	ED-344280	D SILICON H GMA-01-FY2 F05
D802	ED-344280	D SILICON H GMA-01-FY2 F05
D803	ED-344280	D SILICON H GMA-01-FY2 F05
D804	ED-344280	D SILICON H GMA-01-FY2 F05
FL801	EH-429990J	FILTER EMI STB101KBA F05
FL802	EH-429990J	FILTER EMI STB101KBA F05
FL803	EH-429990J	FILTER EMI STB101KBA F05
IC801	EI-430810J	IC ICS2008V
J801	EJ-810705J	PHONE J 3P HLJ0544-010W/N,W6.3
J802	EJ-810706J	PHONE J 3P HLJ0544-110W/N,W6.3
TR801	ET-349593	TR 2SA1348 F05

13. FLASH MEMORY (FMX008M OPTIONAL P.C. BOARD)

Ref.No.	Part No.	Description
IC1	EI-396536J	IC HD74AC138P
IC6	EI-432815J	IC E28F016SA-100
IC7	EI-432815J	IC E28F016SA-100
IC8	EI-432815J	IC E28F016SA-100
IC9	EI-432815J	IC E28F016SA-100
J1	EJ-432816J	SOCKET 128A-060S3B-L14N 60P
TR1	ET-370013	TR 2SA874 O,R
TR2	ET-386938N	TR DTC123ES T05

INDEX

Part No.	Ref. No.	Part No.	Ref. No.	Part No.	Ref. No.	Part No.	Ref. No.
BAL4013A020	2-1	EH364254	3-FL16	EI377191	4-IC2	EJ357159	11-J501
BAL4013A030	2-2	EH384817J	3-IB2	EI379997J	11-IC519	EJ357159	11-J502
BAL4013A040	2-3	EH404248J	11-FL511	EI381290J1	3-IC3	EJ357159	11-J503
BA379695J1	10-21	EH404248J	11-FL512	EI386289J	7-IC2	EJ357159	11-J504
BA810408J	10-16	EH408860J	3-IB3	EI387934J	7-IC5	EJ357159	11-J505
BB810498J	10-4	EH408860J	3-IB4	EI388567J	7-IC3	EJ357159	11-J506
BD810348J	10-37	EH410420J	3-FL1	EI388707J	11-IC501	EJ357159	11-J507
BP810446J	10-8	EH410420J	3-FL2	EI393325N	4-IC12	EJ357159	11-J508
EC425606J	9-C302	EH410420J	3-FL3	EI393325N	4-IC13	EJ358632J2	10-9
EC427562J	9-C301	EH410420J	3-FL4	EI393325N	11-IC515	EJ379603	7-P305
EC427562J	9-C307	EH410420J	3-FL5	EI393325N	11-IC516	EJ405424J	10-42
ED344280	3-D1	EH410420J	3-FL6	EI393325N	11-IC517	EJ424423J	3-J5
ED344280	3-D3	EH410420J	3-FL7	EI393325N	11-IC518	EJ424423J	3-J6
ED344280	4-D5	EH410420J	3-FL8	EI393695J	3-IC11	EJ428182J	3-J2
ED344280	7-D12	EH410420J	3-FL11	EI393696J	11-IC502	EJ429927J	3-P5
ED344280	7-D13	EH410420J	3-FL15	EI394832J	11-IC525	EJ429927J	3-P6
ED344280	7-D14	EH410420J	4-FL4	EI396531J	3-IC17	EJ429929J	3-P7
ED344280	7-D15	EH410420J	4-FL5	EI396536J	13-IC1	EJ430687J	3-J4
ED344280	7-D16	EH410420J	4-FL6	EI396541J	3-X1	EJ430689J	3-P3
ED344280	7-D17	EH410420J	11-FL501	EI397343J	3-IC12-B	EJ430794J	11-J509
ED344280	7-D19	EH410420J	11-FL506	EI397346J	7-IC4-B	EJ430956J	3-J1
ED344280	7-D21	EH410420J	11-FL507	EI401213J	3-IC13	EJ430956J	3-J3
ED344280	7-D23	EH410420J	11-FL508	EI401217J	3-IC8	EJ432816J	13-J1
ED344280	7-D25	EH410420J	11-FL509	EI401217J	3-IC14	EJ810389J	3-J7
ED344280	7-D26	EH413150J	3-FL12	EI405572J	7-IC1	EJ810389J	3-P2
ED344280	7-D27	EH413150J	3-FL13	EI410389J	3-IC19	EJ810418J	6-P3
ED344280	7-D28	EH413150J	3-FL14	EI410414J1	11-IC521	EJ810624J	4-J201
ED344280	7-D29	EH413150J	3-FL17	EI412279J1	4-IC8	EJ810624J	4-J202
ED344280	7-D30	EH413150J	3-FL18	EI412279J1	11-IC503	EJ810624J	4-J205
ED344280	7-D31	EH413150J	3-FL19	EI412279J1	11-IC504	EJ810705J	12-J801
ED344280	7-D32	EH413150J	3-FL20	EI412279J1	11-IC505	EJ810706J	12-J802
ED344280	7-D33	EH413150J	3-FL21	EI412279J1	11-IC506	EM810407J	10-13
ED344280	7-D34	EH413150J	3-FL22	EI413120J	3-IC20	EQ345990N	4-L1
ED344280	7-D35	EH413150J	3-FL23	EI414959J	3-X2	EQ380172J	9-FL301
ED344280	7-D36	EH413150J	3-FL24	EI426988J	3-IC21	EO414952J	11-T501
ED344280	7-D37	EH413150J	3-FL25	EI430673J	3-IC24	EQ348929	4-RL1
ED344280	7-D38	EH413150J	3-FL25	EI430680J	3-IC2	ER200746	4-FR1
ED344280	7-D39	EH413150J	3-FL26	EI430681J	4-IC15	ER200746	4-FR2
ED344280	7-D40	EH413150J	3-FL27	EI430684J	3-IC1	ER324480	11-R565
ED344280	7-D41	EH413150J	3-FL28	EI430810J	12-IC801	ER324480	11-R566
ED344280	12-D801	EH413150J	3-FL29	EI430936J	3-IC35	ER324480	11-R567
ED344280	12-D802	EH413150J	3-FL30	EI430943J	3-IC16	ER324480	11-R568
ED344280	12-D803	EH429990J	12-FL801	EI430943J	3-IC29	ER324480	11-R569
ED344280	12-D804	EH429990J	12-FL802	EI432815J	13-IC6	ER324480	11-R570
ED388539J	7-D2	EH429990J	12-FL803	EI432815J	13-IC7	ER324480	11-R571
ED388539J	7-D3	EH810378J	3-IB5	EI432815J	13-IC8	ER324480	11-R572
ED388539J	7-D5	EH810632J	11-FL1	EI432815J	13-IC9	ER403339N	4-FR3
ED389834J	3-D4	EI348785	11-IC507	EI810047J	3-IC18	ER430691N	4-R67
ED389834J	4-D6	EI348785	11-IC508	EI810153J	3-IC9	ER430691N	4-R68
ED412105N	7-D18	EI348785	11-IC509	EI810153J	3-IC10	ES403377J	8-SW302
ED412105N	7-D20	EI348785	11-IC510	EI810268J	3-IC26	ES411687N	7-SW1
ED412105N	7-D22	EI348785	11-IC511	EI810269J	3-IC27	ES411687N	7-SW2
ED412105N	7-D24	EI348785	11-IC512	EI810269J	3-IC28	ES411687N	7-SW3
ED428162N	3-D2	EI348785	11-IC513	EI810328J	3-IC5	ES411687N	7-SW4
ED810393J	7-D1	EI348785	11-IC514	EI810328J	3-IC6	ES411687N	7-SW5
ED810393J	7-D4	EI353227	4-IC14	EI810379J	3-IC4	ES411687N	7-SW6
ED810393J	7-D6	EI354123	7-X1	EI810380J	3-IC7	ES411687N	7-SW7
ED810393J	7-D7	EI360043	4-IC3	EI810381J	3-IC12-A	ES411687N	7-SW8
ED810393J	7-D8	EI360043	4-IC4	EI810382J	3-IC15	ES411687N	7-SW9
ED810393J	7-D9	EI360043	4-IC10	EI810382J	3-IC33	ES411687N	7-SW10
ED810393J	7-D10	EI360043	4-IC11	EI810383J	3-IC23	ES411687N	7-SW11
ED810393J	7-D11	EI362587J1	7-IC6	EI810384J	3-IC30	ES411687N	7-SW12
EF346880	4-FS1	EI362587J1	7-IC7	EI810385J	3-IC31	ES411687N	7-SW13
EF346880	4-FS2	EI374176	11-X501	EI810386J	3-IC34	ES411687N	7-SW14
EF373142	3-FS1	EI376741J1	3-IC22	EI810412J	4-IC5	ES411687N	7-SW15
EF373143	11-FS502	EI377047	3-IC32	EI810613J	3-IC25	ES411687N	7-SW16
EF376821	11-FS501	EI377101	4-IC6	EI810630J	7-IC4-A	ES411687N	7-SW17
EH349374	7-IB1	EI377101	4-IC9	EI810646J	11-IC524	ES411687N	7-SW18
EH349374	7-IB2	EI377101	11-IC522	EJ354105	4-J203	ES411687N	7-SW19
EH357538	3-IB1	EI377191	4-IC1	EJ354105	4-J204	ES411687N	7-SW20

Part No.	Ref. No.	Part No.	Ref. No.	Part No.	Ref. No.	Part No.	Ref. No.
ES411687N	7-SW21	ZW413267	10-7				
ES411687N	7-SW23	ZW810346J	10-17				
ES411687N	7-SW24	ZW810347J	10-14				
ES411687N	7-SW25						
ES411687N	7-SW26						
ES411687N	7-SW27						
ES411687N	7-SW32						
ES411687N	7-SW33						
ES411687N	7-SW34						
ES411687N	7-SW35						
ES411687N	7-SW36						
ES411687N	7-SW37						
ES411687N	7-SW38						
ES411687N	7-SW39						
ES411687N	7-SW40						
ES415015J	7-SW22						
ES415015J	7-SW28						
ES415015J	7-SW29						
ES415015J	7-SW30						
ES415015J	7-SW31						
ES415015J	7-SW41						
ES430685J1	9-SW301						
ET349593	12-TR801						
ET366753N	4-TR1						
ET370013	13-TR1						
ET386938N	13-TR2						
ET430926J	3-PH1						
ET430926J	3-PH2						
EV810416J	5-VR201						
EV810417J	5-VR202						
EV810633J	7-VR1						
EW368420J1	10-41-B						
EW380905J	10-41-A						
EW410608J	10-41-C						
EW419170J	10-41-D						
EW810390J	3-W101						
EW810396J	7-W304						
EW810415J	4-W203						
EW810419J	6-W204						
EW810423J	11-W501						
SA810344J	10-1						
SB413601J1	10-27						
SB429685J	10-22						
SB430327J	10-24						
SB810359J	10-25						
SB810360J	10-26						
SB810362J	10-23						
SB810525J	10-19						
SE376331	10-20						
SE810353J	10-40						
SE810673J	10-28						
SE810674J	10-29						
SK411144J	10-35						
SK411147J	10-36						
SK810361J	10-32						
SK810363J	10-33						
SK810364J	10-34						
SP810424J	10-30						
ZS320906	10-3						
ZS322570	10-5						
ZS322570	10-39						
ZS331182	10-31						
ZS345272	10-11						
ZS348375	10-38						
ZS350934	10-12						
ZS376875	10-6						
ZS379405N	10-2						
ZS400878J	10-18						
ZS428277J	10-10 ⁷						
ZS810640J	10-15						

PARTS LIST

ABBREVIATION	EXPLANATION	ABBREVIATION	EXPLANATION
AMP (Amp)	AMPlifier	MINI	MINimum
BBD	Backet Brigade Diode	MIX	MIXer
BCD	Binary Code Decimal	MOD	MODulation / MODulator
B.DOWN	Brake DOWN	M.WHEEL	Modulation WHEEL
B.UP	Back UP	OSC	OSCillator
CE	Chip Enable	PLD	Programmable Logic Device
CH	CHannel	RAM	Random Access Memory
COMP	COMParator	RD	ReaD
CONT	CONTRol	REG	REGulator
CV	Control Voltage	RESO	RESOnance
D/A	Digital to Analogue	RL	ReLay
DIR	DIRectory	ROM	Read Only Memory
DMA	Direct Memory Access	SCSI	Small Computer System Interface
DSP	Digital Signal Processor	S/H	Sample and Hold
EG	Envelope Generator	SIMM	Single Inline Memory Module
EXT	EXTernal	SMPTE	Society of Motion Picture & Television Engineers
FREQ	FREQuency	SW	SWitch
HPF	High Pass Filter	THRU	THRUgh
INH	INHibit	TRANS	TRANSpose
INT	INTerrupt	U	Upper
INV	INVerter	VA	Voltage Analog
L	Lower	VCA	Voltage Controlled Amplifier
LAN	Local Area Network	VCF	Voltage Controlled Filter
LFO	Low Frequency Oscillator	VR	Variable Resistor
MAX	MAXimum	VREF	REFerence Voltage
MEMO	MEMOry	WR	WRite
MIDI	Musical Instrument Digital Interface		

AKAI ELECTRIC CO., LTD.

ELECTRONIC MUSICAL INSTRUMENT DIV.

12-14, 2-Chome, Higashi-Kojiya, Ohta-ku, Tokyo, Japan
SERVICE SECT. TEL:Tokyo (3745) 9621 FAX:Tokyo (3745) 9633

Printed No. 961122-A1-300 Printed Date December 27, 1996

Printed in Japan