

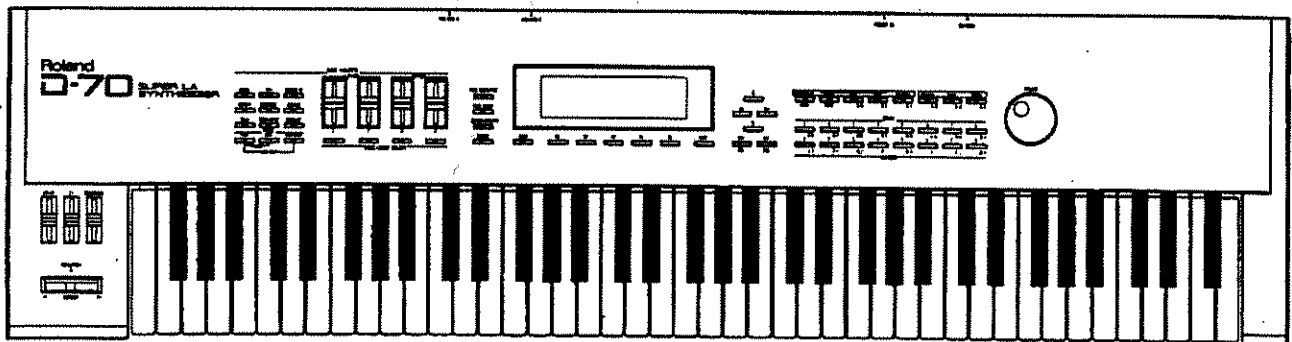

Roland

SUPER LA SYNTHESIZER

D-70

OWNER'S MANUAL



	CAUTION RISK OF ELECTRIC SHOCK DO NOT OPEN	
ATTENTION : RISQUE DE CHOC ELECTRIQUE NE PAS OUVRIR		
CAUTION: TO REDUCE THE RISK OF ELECTRIC SHOCK, DO NOT REMOVE COVER (OR BACK). NO USER-SERVICEABLE PARTS INSIDE. REFER SERVICING TO QUALIFIED SERVICE PERSONNEL.		



The lightning flash with arrowhead symbol, within an equilateral triangle, is intended to alert the user to the presence of un-insulated "dangerous voltage" within the product's enclosure that may be of sufficient magnitude to constitute a risk of electric shock to persons.



The exclamation point within an equilateral triangle is intended to alert the user to the presence of important operating and maintenance (servicing) instructions in the literature accompanying the product.

INSTRUCTIONS PERTAINING TO A RISK OF FIRE, ELECTRIC SHOCK, OR INJURY TO PERSONS.

IMPORTANT SAFETY INSTRUCTIONS

WARNING — When using electric products, basic precautions should always be followed, including the following:

1. Read all the instructions before using the product.
2. Do not use this product near water — for example, near a bathtub, washbowl, kitchen sink, in a wet basement, or near a swimming pool, or the like.
3. This product should be used only with a cart or stand that is recommended by the manufacturer.
4. This product, either alone or in combination with an amplifier and headphones or speakers, may be capable of producing sound levels that could cause permanent hearing loss. Do not operate for a long period of time at a high volume level or at a level that is uncomfortable. If you experience any hearing loss or ringing in the ears, you should consult an audiologist.
5. The product should be located so that its location or position does not interfere with its proper ventilation.
6. The product should be located away from heat sources such as radiators, heat registers, or other products that produce heat.
7. Avoid using the product where it may be effected by dust.
8. The product should be connected to a power supply only of the type described in the operating instructions or as marked on the product.
9. The power-supply cord of the product should be unplugged from the outlet when left unused for a long period of time.
10. Do not tread on the power-supply cord.
11. Do not pull the cord but hold the plug when unplugging.
12. When setting up with any other instruments, the procedure should be followed in accordance with instruction manual.
13. Care should be taken so that objects do not fall and liquids are not spilled into the enclosure through openings.
14. The product should be serviced by qualified service personnel when:
 - A. The power-supply cord or the plug has been damaged; or
 - B. Objects have fallen, or liquid has been spilled into the product; or
 - C. The product has been exposed to rain; or
 - D. The product does not appear to operate normally or exhibits a marked change in performance; or
 - E. The product has been dropped, or the enclosure damaged.
15. Do not attempt to service the product beyond that described in the user-maintenance instructions. All other servicing should be referred to qualified service personnel.

SAVE THESE INSTRUCTIONS

WARNING: THIS APPARATUS MUST BE EARTHED

IMPORTANT: THE WIRES IN THIS MAINS LEAD ARE COLOURED IN ACCORDANCE WITH THE FOLLOWING CODE.
GREEN-AND-YELLOW: EARTH, BLUE: NEUTRAL, BROWN: LIVE

As the colours of the wires in the mains lead of this apparatus may not correspond with the coloured markings identifying the terminals in your plug proceed as follows:

The wire which is coloured GREEN-AND-YELLOW must be connected to the terminal in the plug which is marked by the letter E or by the safety earth symbol  or coloured GREEN or GREEN-AND-YELLOW.

The wire which is coloured BLUE must be connected to the terminal which is marked with the letter N or coloured BLACK.

The wire which is coloured BROWN must be connected to the terminal which is marked with the letter L or coloured RED.

For the U.K.

The product which is equipped with a THREE WIRE GROUNDING TYPE AC PLUG must be grounded.

SUPER LA SYNTHESIZER **D-70**

Owner's Manual

INTRODUCTION

Thank you for purchasing the Roland D-70 Super LA Synthesizer. To take full advantage of the D-70's functions and enjoy long and trouble-free use, please read this owner's manual carefully.

Copyright © 1990 by ROLAND CORPORATION

All rights reserved. No part of this publication may be reproduced in any form without the permission of ROLAND CORPORATION.

HOW TO USE THIS MANUAL

■ The modes of the D - 70

The functions of the D - 70 are organized into four modes; PLAY, EDIT, PCM CARD, and ROM PLAY.

● Play mode

You will normally play the D - 70 in this mode. Data can be adjusted even while playing.

● Edit mode

This mode allows you to edit and transfer data.

● PCM Card mode

This mode allows you to check the sounds of a PCM Card (sold separately).

*PCM Card mode can be selected while in Play mode.

● ROM Play mode

This mode allows you to hear the demo song built into the D - 70.

■ How to select a mode

To select a mode, press a button on the front panel.

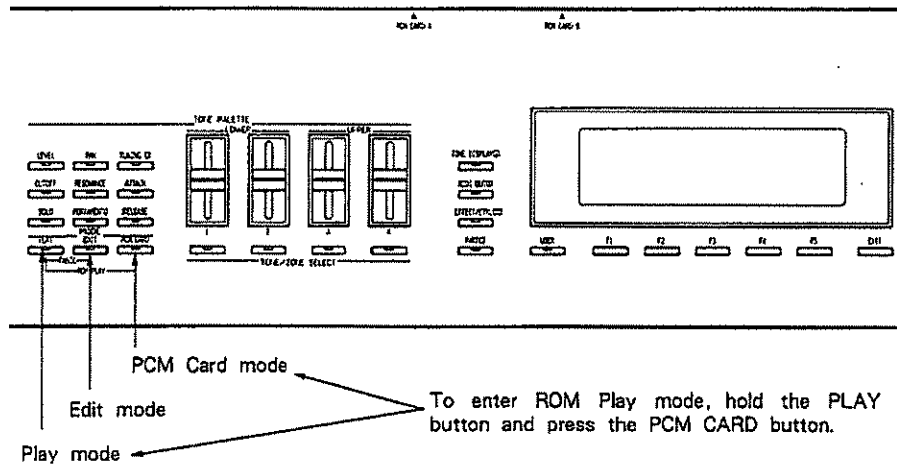

The indicator of the selected button will light.

* Do not switch the unit off when the ROM Play mode is being selected.



Mode Chart

■ Play Mode

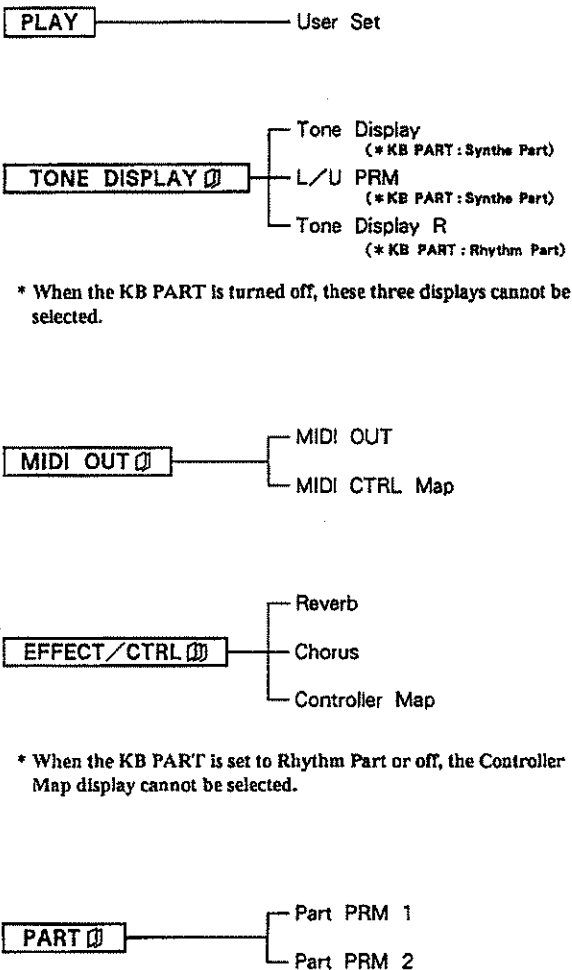

■ PCM Card Mode

* You can move to the PCM Card mode from the Play mode.



■ ROM Play Mode



■ Edit Mode

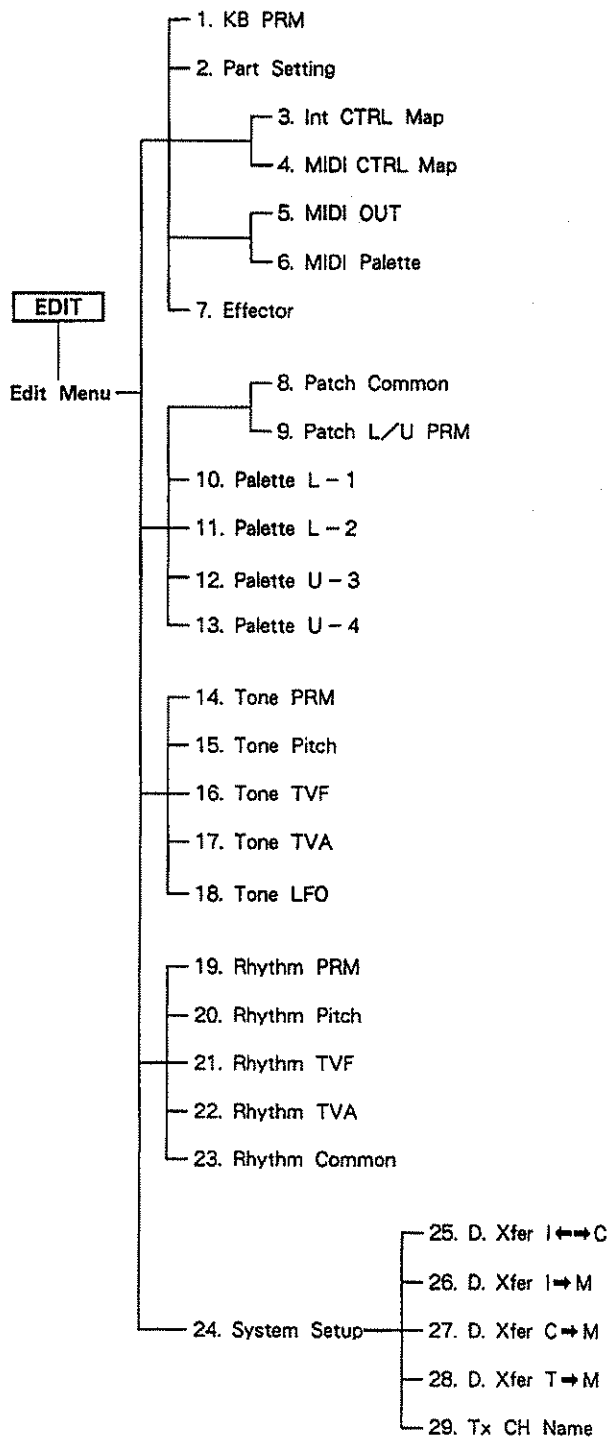

Cut off at the perforated line.

Performance

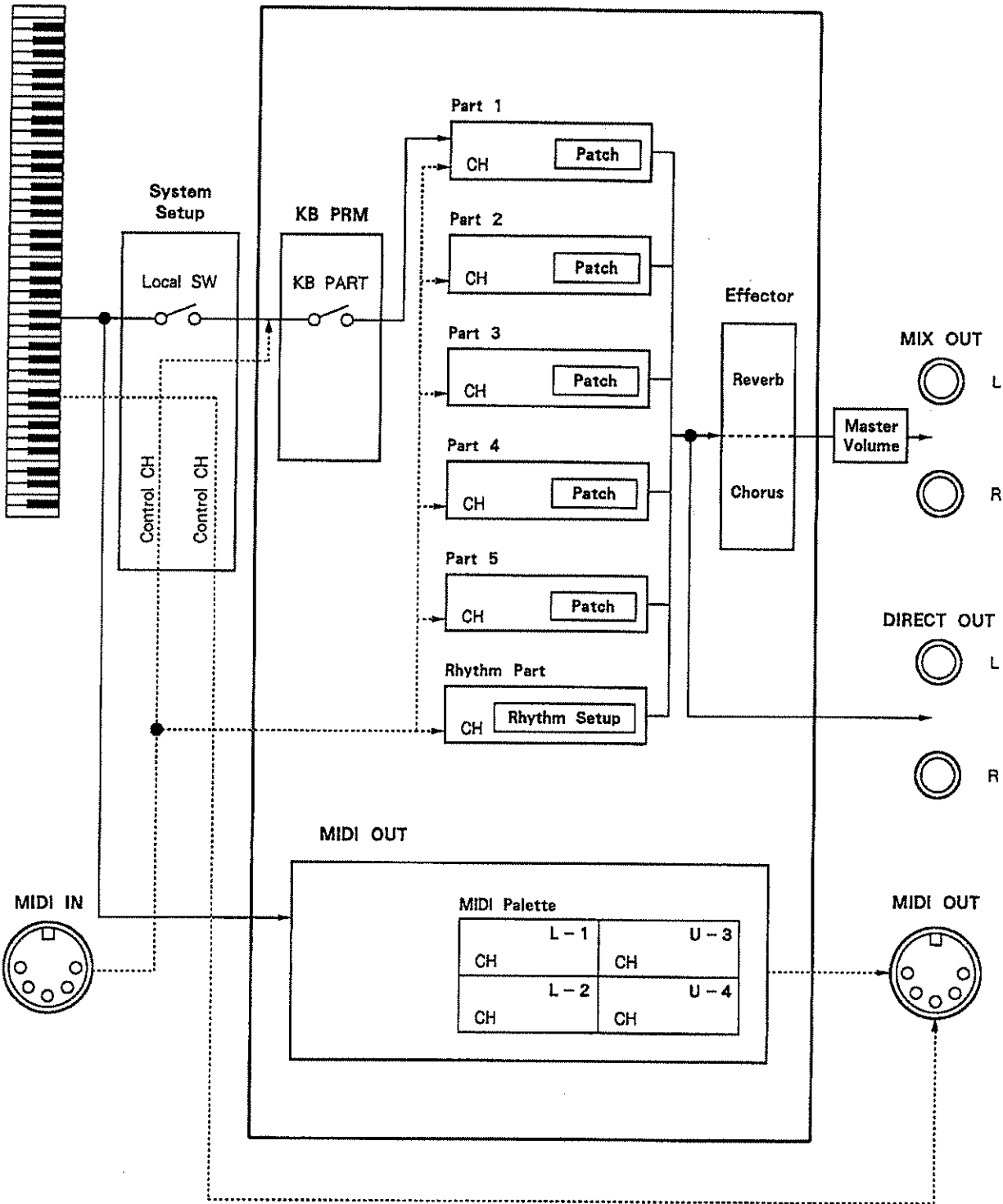

* -----> MIDI Signal

■ How to read this manual

This manual is organized according to the modes of the D - 70, as follows. Read each chapter when necessary.

Chapter 1 Getting started

This chapter explains how to get the D - 70 ready to play, select Performances, connect the D - 70 with external devices, and try out the sounds.

Chapter 2 Play

This chapter explains basic knowledge you will need to use Play mode; how the D - 70 is organized, how to perform various operations, and the meaning of the display screens in Play mode.

Chapter 3 Edit

This chapter explains how to edit, how a Tone is organized, how memory is organized, editing procedures, and the meaning of the display screens in Edit mode. PCM Card mode is also covered in this chapter.

Chapter 4 Write/Command





This chapter explains how to save (Write) edited data, and other functions (Commands) useful for managing data.

Chapter 5 Appendix





This contains error messages, troubleshooting, a list of parameters, and other information.

■ Conventions used in this manual

D - 70 panel buttons you must press will be indicated in this manual as follows.

(Example) PLAY button → 
 cursor buttons →  /  /  / 

When you are required to hold one button and press another button, this will be indicated as follows.

(Example) while holding  press 
 →  + 

Controllers other than buttons are indicated as 

(Example) value dial → 

● About the display

Various display screens are printed and referred to in this manual, but the displayed data (sound names, etc.) does not necessarily correspond to the factory set data.

CONTENTS

MAIN FEATURES	9
IMPORTANT NOTES	10
FRONT AND REAR PANEL	11

Chapter 1 Getting started

① PREPARATIONS BEFORE PLAYING	14
1. Connections	14
2. Turn the Power On	15
② ROM PLAY	16
③ PLAY THE D - 70	17
1. To Select a Performance	17
■ Selecting a Performance from the User Set display ..	17
■ Selecting a Performance from the Performance List ..	19
2. Try Out the Playing Functions	20
■ Velocity	20
■ Aftertouch	20
■ Bender/Modulation Lever	20
3. Master Tune	21
4. Adjust the Tone	22

Chapter 2 Play

① GENERAL OVERVIEW	24
1. How the D - 70 is organized	24
2. Patches	26
■ How a Tone Palette is organized	26
● Output Assign	26
■ Patch parameters	27
● Key Mode	27
● Velocity Mode and Threshold Sensitivity	27
● Key Assign and Solo Legato	28
● Portamento	28
3. Performance	29
■ How a MIDI Palette is organized	29
■ Performance parameters	30
● Key Mode	30
● Velocity Mode and Threshold Sensitivity	30
4. Key Mode and Zone	31
■ Each Part has a Zone	31
■ Key Mode and Zone	32
5. Controllers	33
■ Types of controller	33
■ The Controller Map	34
● Internal Controller settings	34
● Controller settings for MIDI OUT	34
6. Signal Flow	35
■ Keyboard data flow	35
■ MIDI data flow	35
7. RAM Card Data	36

② BASIC OPERATION (PLAY MODE)	37
1. How to View the Screen	37
■ The function buttons	37
2. How to Select Displays	38
3. How to Modify Settings	39
■ Basic procedure to modify settings	39
■ To use the Tone Palette Sliders	39
● To edit Tone Palette parameters	40
● To edit MIDI Palette parameters	41
● To edit the Effect parameters	42
■ To use TONE/ZONE SELECT	43
● To mute a Tone	43
● To select a Tone	43
● Zone settings for a Tone	43
● Output Assign settings	43
● To mute a MIDI Channel	44
● To output a Program Change message	44
● Zone settings for a MIDI Channel	44
■ To select a Performance, Patch, or Tone	44
● To select a Performance	44
● To select a Patch	45
● To select a Tone	45
■ To transmit a Program Change message	46
■ How to use SOLO and PORTAMENTO	47
4. RAM Card	48
■ How to insert a RAM Card	48
■ The RAM Card protect switch	48
5. Using MIDI to Select Performances or Patches	49
■ To select Performances	49
■ To select Patches	50
■ About Program Change Numbers	50
6. The Panic Function	51
■ Transmitted data	51

③ FUNCTIONS OF EACH DISPLAY (PLAY MODE)	52
1. User Set	52
■ To select a User Set Group	52
■ To select a Performance	52
2. Tone Display	53
■ To set Key Assign	53
■ To set Output Assign	53
■ To set Patch Level	53
■ To set Key Mode	54
■ To set the Split Point	54
■ To use the Tone Palette Sliders to edit	54
3. L/U PRM	56
■ To specify how sounds will be produced	56
■ To set the Key Mode	57
■ To set the Split Point	57

4. Tone Display R	58
■ To check the settings of the Rhythm Setup	58
■ To set the level of the Rhythm Part	58
5. Reverb	59
■ To make Reverb settings using the Tone Palette Sliders	59
■ To make Output Assign settings	60
6. Chorus	61
■ To make Chorus settings using the Tone Palette Sliders	61
■ To make Chorus settings using the cursor	62
■ To make Output Assign settings	63
7. Controller Map	64
■ To set the Controller Map	64
● To select a Controller	64
● To specify the functions of a Controller	64
● To specify the keyboard range to which the effect will apply	65
8. Part PRM 1/2	66
■ Part settings	66
■ To select the KB PART	67
9. MIDI OUT	68
■ To set MIDI Channels	68
■ To set Velocity Mode/Threshold Sensitivity	68
■ To check Program Change Numbers	68
■ To set the Key Mode	69
■ To set the Split Point	69
■ To edit using the Tone Palette Sliders	69
10. MIDI CTRL Map	71
■ To set the Controller Map	71
● To select a Controller	71
● To specify the functions of a Controller	71
● To specify the keyboard range to which the effect will apply	72

Chapter 3 Edit

1 OVERVIEW OF EDITING	74
1. Tones	74
■ Maximum simultaneous notes	75
■ Keyboard range	75
2. PCM and DLM	76
■ If the WG is set to PCM	76
■ If the WG is set to DLM	76
3. How Memory is organized	78
■ About data in the Temporary area	80
● When you Edit or Write	80
● When you change Modes or execute the Panic function	81
● When you execute a command	81
4. Rhythm Setup	82

2 BASIC PROCEDURES (EDIT MODE)	83
1. How to View the Display	83
■ About the Function buttons	83
2. How to Select Displays	84
■ Use the Menu to select a display	85
■ Use the Direct Jump function to select a display	85
● Direct Jump	85
● How to set a Jump Destination	86
■ To return to the previous higher level press EXIT	86
■ To return to the Edit menu press EDIT	86
3. How to Modify Settings	87
■ Basic procedure to modify settings	87
● How to enter characters	87
■ Edit using the Tone Palette Sliders	88
● To assign a slider	88
● To cancel a slider assignment	88
■ Using TONE/ZONE SELECT	89
● To mute a Tone	89
● To select a Tone	89
● To change Sections	89
● To change Key Numbers	89
■ How to select Performances, Patches, and Tones	90
● To select Performances	90
● To select Patches	90
● To select Tones	91
■ How to use SOLO and PORTAMENTO	92
4. PCM Cards	93
■ How to insert a PCM Card	93
5. Selecting an Original Tone	94
6. Points to Remember While Editing	95
■ Editing a Part	95
■ Editing a Tone	95
■ Using Write or Command	95

3 FUNCTIONS OF EACH DISPLAY (EDIT MODE)	96
■ Performance Edit	96
1. KB PRM	96
2. Part Setting	98
3. Int CTRL Map	99
4. MIDI CTRL Map	101
5. MIDI OUT	102
6. MIDI Palette	104
7. Effector	105
■ Patch Edit	107
8. Patch Common	107
9. Patch L/U PRM	108
10. Palette L-1	111
■ Tone Edit	114
14. Tone PRM	114
15. Tone Pitch	115

16. Tone TVF	118
17. Tone TVA	124
18. Tone LFO	127
■ Rhythm Setup	129
19. Rhythm PRM	129
20. Rhythm Pitch	132
21. Rhythm TVF	133
22. Rhythm TVA	134
23. Rhythm Common	136
■ System Setup	137
24. System Setup	137
25. D.Xfer I ↔ C	139
26. D.Xfer I → M	141
27. D.Xfer C → M	143
28. D.Xfer T → M	144
29. Tx CH Name	146

④ PCM CARD MODE	147
■ To select an Original Tone	147

Chapter 4 Write/Command

① WRITE	150
1. Different Types of Write Operation	150
2. Caution When Writing Data	151
3. Procedures	152
■ Select the Write display	152
■ Select the Write destination	152
● When writing a Performance or Patch	152
● When writing a Tone	152
■ Execute the Write operation	153
4. How to Assign a Performance to a User Set	154
■ Specify the Performance to assign	154
■ Select the Write display	155
■ Select the writing destination	155
■ Execute the Write operation	155
② COMMAND	156
1. Types of Command	156
2. Command Functions	157
● Copy	157
● Initialize	157
● Exchange	157
■ Special Commands	157
● CH Setting	157
● Orig. Tone PRM	158
● Store All	158
● Name Delete	158
3. Notes When Executing a Command	159
4. Procedures	160
■ To execute Copy, Initialize, or Exchange	160

■ To modify the CH Setting	162
■ To execute Orig. Tone PRM	163
■ To execute Store All	164
■ To execute Name Delete	166

Chapter 5 Appendix

① ERROR MESSAGES	168
② TROUBLESHOOTING	170
③ PARAMETER LIST	174
④ INITIALIZE DATA	182
⑤ ORIGINAL TONE	186
⑥ DLM	187
⑦ FACTORY PRESET	188
⑧ ABOUT MIDI	195
Roland Exclusive Messages	198
MIDI Implementation	202
MIDI Implementation Chart	211
SPECIFICATIONS	213
INDEX	215

MAIN FEATURES

The D-70 is a multi-timbral synthesizer using an Advanced LA Synthesis sound source which contains a large number of high-quality sounds and a TVF to modify these sounds. It also acts as a full-function MIDI keyboard controller, and is the perfect choice for use on stage or in the studio.

● High - quality PCM Wave and DLM

The D - 70 contains PCM waves (fragments of sound) such as white noise, sawtooth wave, and short PCM loops. These can be processed by the TVF to create a wide variety of sounds. In addition to these, a wide range of high quality PCM Waves are provided, ranging from realistic acoustic sounds to synthesizer sounds. These PCM Waves can also be processed by the TVF to create your own original sounds. In addition, DLM (Differential Loop Modulation) takes a section of this PCM Wave, and adds loop modulation to it, creating inharmonic partials which were not present in the original PCM Wave. This can be further processed through the TVF to create completely new sounds. In addition to the internal PCM Waves, separately sold PCM Cards (SN - SPLA series, SN - U110 series) can also be used, for even greater sound-creating possibilities.

● Sound creation using PCM + TVF

The D - 70 is the first of the D-series to offer sound creation using PCM+TVF. The newly developed TVF (Time Variant Filter) provides three modes (low pass, high pass and band pass) and Resonance as well. This allows you to go beyond simple PCM Wave playback, and to create new and expressive sounds.

● Digital effect unit

The D - 70 has a built-in reverb/chorus digital effects unit, creating a spacious stereo depth.

● Performance keyboard

The D - 70 is designed to be an especially powerful live performance instrument. For example, a function can be assigned to the four Tone Palette sliders, allowing you to operate the sliders to modify the sound in realtime while playing.

● Easy to use

The big display provides you with a large amount of information at a glance. In addition, frequently used displays have their own dedicated button, allowing you to recall the display instantly. Also, the Direct Jump function lets you move quickly to a desired editing display.

● Three key modes

The D - 70 has three Key modes; Layer, Split, and Zone. You can use the mode most suitable for your musical needs, and switch between Key modes at the press of a button.

● User set

Any desired Performance (sound) can be assigned to one of the five function buttons (User Set). Ten groups of User Sets are provided, so a total of 50 Performances can be selected using the function buttons.

● Flexible controllers

Each controller can be assigned two different functions, allowing a single controller operation to have two different effects.

● 76 - note keyboard

The velocity- and aftertouch-sensitivity keyboard of the D - 70 allows playing dynamics or key pressure to control the tone or volume. The 76-note keyboard allows you to take full advantage of the various Key modes.

● Multi - timbral operation

The multi-timbral sound source of the D - 70 can simultaneously produce five parts and a rhythm part. When used in conjunction with a MIDI sequencer, a single D - 70 can produce the sound for an entire ensemble.

● Panic function

The Panic function allows instant recovery from "stuck" or "hanging" notes on external sound sources or the D - 70 itself.

● Memory Card

A separately sold RAM Card (M - 256E) can store all settings of the D - 70. While playing, you can instantly recall Performances etc. from a RAM Card.

IMPORTANT NOTES

In addition to the items listed under Safety Precautions on page 2, please read and adhere to the following:

Power Supply

- When making any connections with other devices, always turn off the power to all equipment first; this will help prevent damage or malfunction.
- Do not use this unit on the same power circuit with any device that will generate line noise, such as a motor or variable lighting system.

Placement

- This unit may interfere with radio and television reception. Do not use this unit in the vicinity of such receivers.
- Do not expose this unit to temperature extremes (eg. direct sunlight in an enclosed vehicle can deform or discolor the unit) or install it near devices that radiate heat.

Maintenance

- For everyday cleaning wipe the unit with a soft, dry cloth (or one that has been slightly dampened with water). To remove stubborn dirt, use a mild neutral detergent. Afterwards, be sure to wipe the unit thoroughly with a soft, dry cloth.
- Never use benzine, thinners, alcohol or solvents of any kind, to avoid the risk of discoloration and/or deformation.

Additional Precautions

- Protect the unit from strong impact.
- Never strike or apply strong pressure to the display.
- A small amount of heat will radiate from the unit, and thus should be considered normal.
- Before using the unit in a foreign country, consult with qualified service personnel.

Memory Backup

- The unit contains a battery which maintains the contents of memory while the main power is off. The expected life of this battery is 5 years or more. However, to avoid the unexpected loss of memory data, it is strongly recommended that you change the battery every 5 years.
Please be aware that the actual life of the battery will depend on the physical environment (especially temperature) in which the unit is used. When it is time to change the battery, consult with qualified service personnel.
- When the battery becomes weak the following message will appear in the display in turning the power on: **Internal Battery Low! (EXIT)**. However, by that time the contents of memory may have already been lost.
- Please be aware that the contents of memory may at times be lost; when the unit is sent for repairs or when by some chance a malfunction has occurred. Important data should be stored on a RAM Card, or written down on paper. During repairs, due care is taken to avoid the loss of data. However, in certain cases, (such as when circuitry related to memory itself is out of order) we regret that it may be impossible to restore the data.

FRONT AND REAR PANEL

[FRONT PANEL]

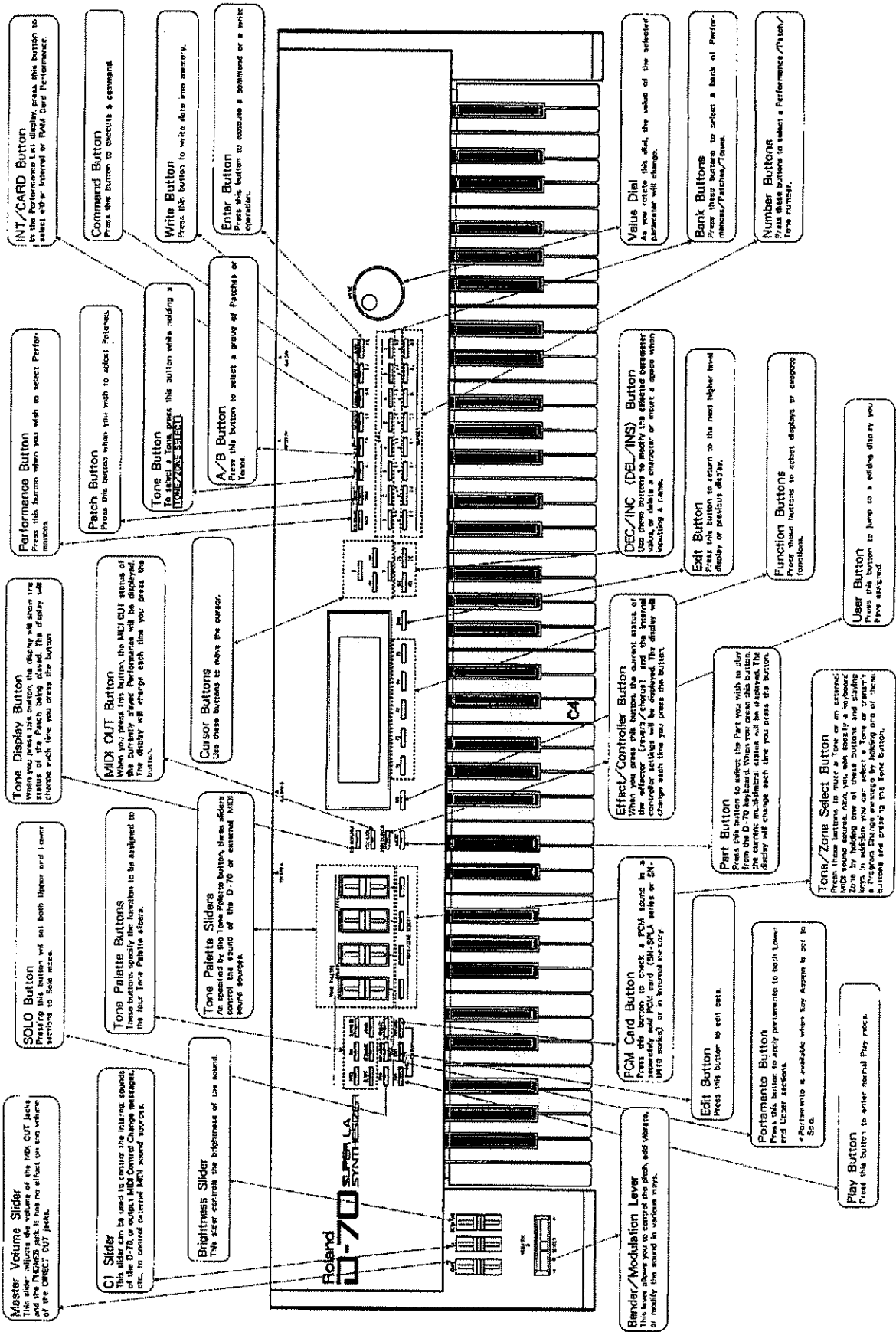

【REAR PANEL】

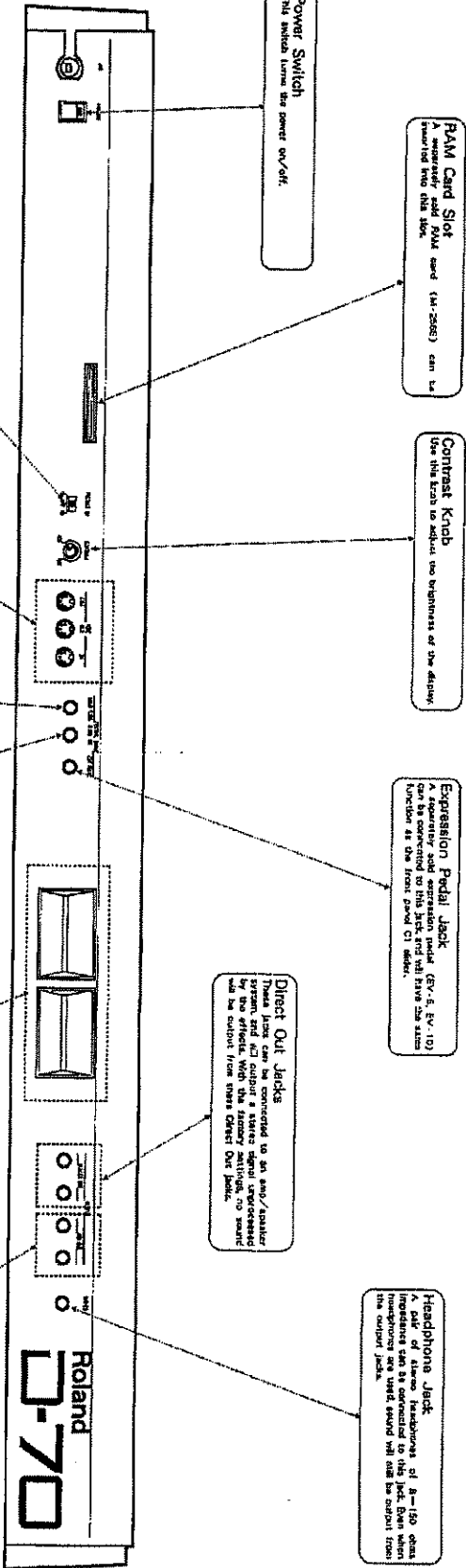

RAM Card Slot
An expansion card (M-2563) can be inserted into this slot.

Power Switch
This switch turns the power on/off.

Contrast Knob
Use this knob to adjust the brightness of the display.

Expression Pedal Jack
A separate foot expression pedal (EV-5, EV-10) can be connected to this jack. The EV-10 has a function of the foot pedal ON effect.

Direct Out Jacks
These jacks can be connected to an amp/speaker system and will output a stereo signal (unprocessed). The output level can be adjusted. No source can be output from these Direct Out jacks.

Headphone Jack
A pair of stereo headphones of 8-150 ohms impedance can be connected to this jack. Even when the volume knob is turned, you will not hear the output from the output jacks.

MIDI In

MIDI Out

Protect Switch
This switch prevents memory data from accidentally being overwritten and lost. Normally you should leave this ON. When you write data into memory, turn this switch OFF.

MIDI Connectors
These connectors allow the D-70 to be connected to other MIDI devices.

Hold Pedal Jack
A separate hold pedal (SR-1, SR-2, and SR-3) can be connected to this jack and used to control Hold or Sustain.

Pedal Switch Jack
A separate foot pedal switch (FS-1, FS-2, and FS-3) can be connected to this jack, and used to select the instrument sound of the D-70, or to control external MIDI sound systems.

PCM Card Slot
Separately sold memory cards (901, 921A, and 921B or SR-1110 series) can be inserted into these slots.

MIDI Out Jacks
These jacks can be connected to an amp/speaker system and will output a stereo signal (unprocessed). Each instrument sound can be output independently from the MIDI Out jacks and Direct Out jacks. Normally, you will connect the MIDI Out jacks to an amp/speaker system.

Roland
D-70

Getting started

1 PREPARATIONS BEFORE PLAYING

1. Connections

The D - 70 does not contain an amplifier/speaker system. You can either use headphones, or an external amplifier/speaker system.

Before you make connections, make sure that the power switches of the D - 70 and the amplifier are turned off. Making connections with the power turned on may damage the speakers.

By removing the plug adapter from the included cable, it can be connected directly to a stereo set.

In order to take full advantage of the D - 70, we recommend that you listen to it in stereo, but if you are listening in mono, connect the L (MONO) jack.

*With the factory settings, no sound will appear at the DIRECT OUT jacks.

*When connecting the D - 70 directly to a home audio system, be careful of the output level. High volumes may damage your speakers.

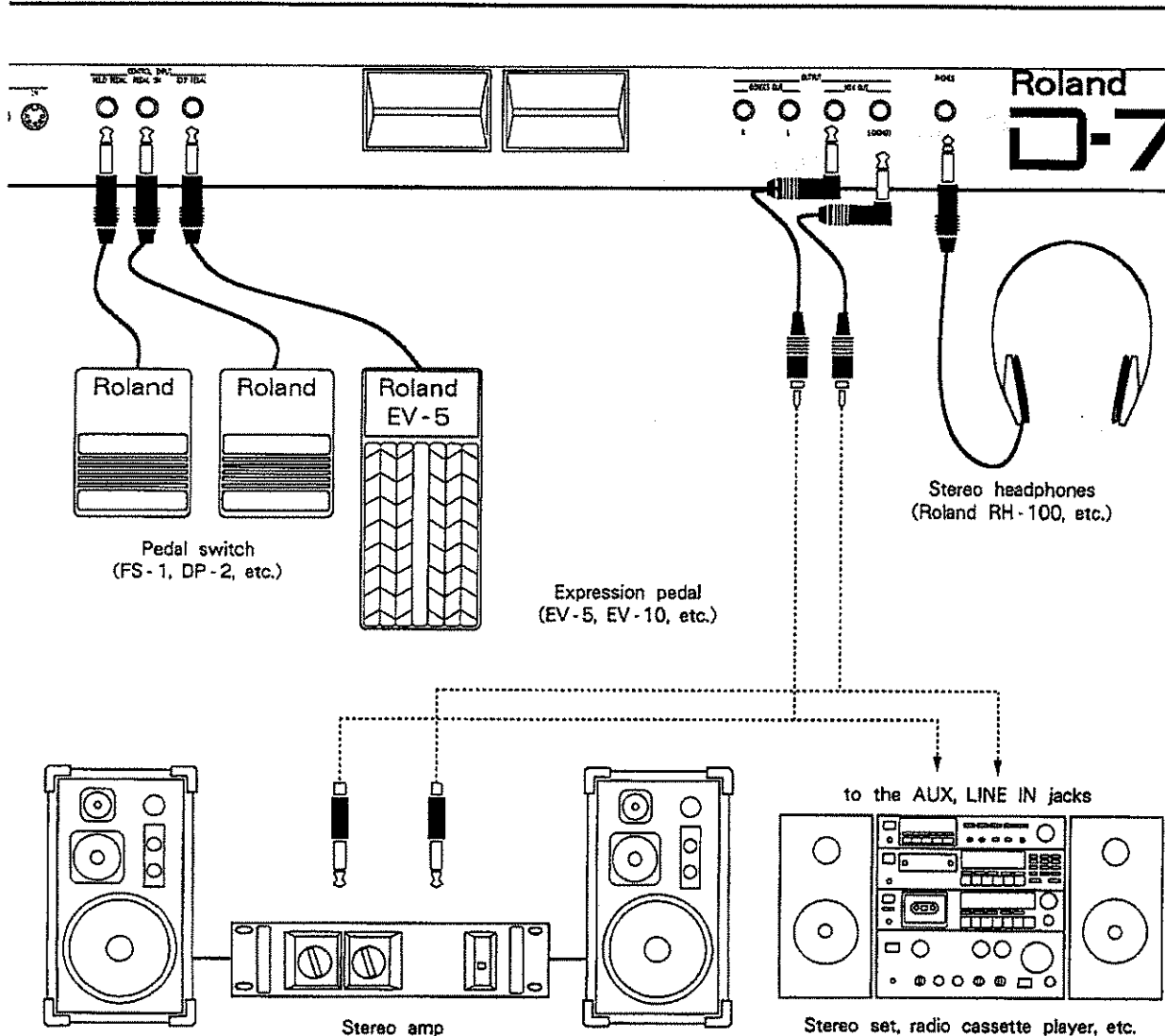

2. Turn the Power On

Before you turn the power on, check the following points.

- Are the connections made correctly?
- Are the volume controls of the amplifier turned down?

[Procedure]

- ① Turn on the D - 70 power switch.

The following display will appear.

```

I:11 Hvy Guitar [ * ]
[ * ]          [ 1 ]
User Set.      I- 1 2 3 4 5 6 7 8 9 10
[ * ]          C- 1 2 3 4 5 6 7 8 9 10
               Carillon   E.Piano
Hvy Guitar    Gajans     Endoguitar
    
```

- ② Turn on the amplifier and other external devices.

Play the keyboard and you will hear sound.

- * The D - 70's protection circuit will insert a short wait after the power is turned on until operation begins.
- * When turning the power off, first turn the amplifier off, and then turn the D - 70 off.

- ③ Use the master volume to adjust the volume.

* The master volume will not affect the volume of DIRECT OUT (L/R).

Any data preprogrammed from the manufacturer will be erased if the WRITE (see page 150) or STORE ALL (see page 158) is done. If you wish to retain the preprogrammed data, save it onto an optional RAM Card (M - 256E) using "RAM Card Formatting" function explained on page 140 before editing or executing WRITE/STORE ALL.

* Editing Rhythm Setup/System Setup changes its data directly.

2 ROM PLAY

The D-70 contains demo song that demonstrate its multi-timbral capabilities. *ROM play mode* automatically plays this song. When using the ROM play function, we suggest that you connect a stereo amplifier or listen through headphones in order to get the full benefit of the D-70's multi-timbral capabilities.

[Procedure]

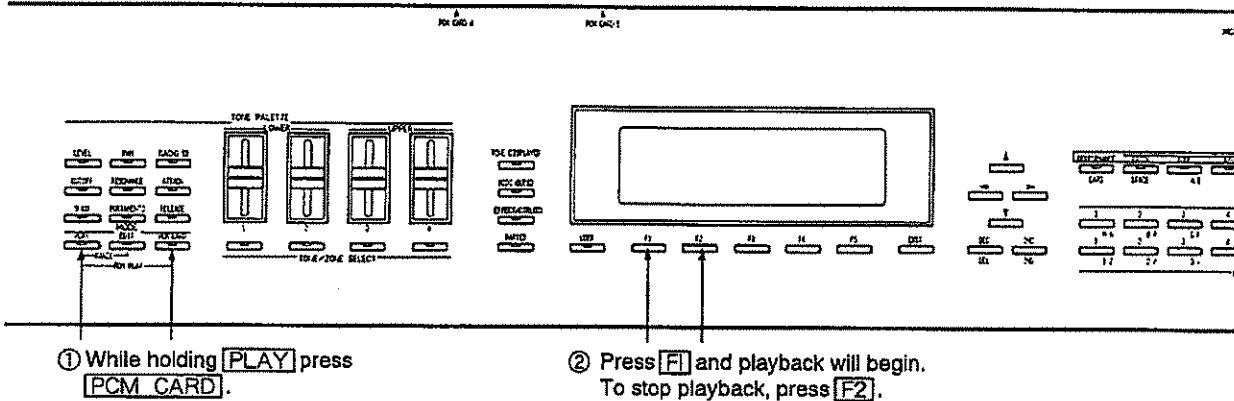

Note: If you switch the unit off when the ROM Play screen is being selected, the Rhythm Setup data will be erased.

To avoid this, return to the Play mode first with the **PLAY**, then switch the unit off.

Song Title	Biographies of Composers
<p>Schizoid</p> <p>Music by Eric Persing</p> <p>Copyright © 1990, Eric Persing Music</p>	<p>Eric Persing</p> <p>Eric Persing is one of the most in - demand session players and programmers in the Los Angeles area. Eric began working for Roland as a product specialist, first doing clinics and support, then gradually became more involved in product and sound design. Eric has worked with such artists as Michael Jackson, Deniece Williams, Lionel Richie, Larry Carlton, and REO Speedwagon. His music and sounds can also be heard on many TV shows and commercials. Actively involved in film music, he has worked with top composers including Michel Colombier, Danny Elfman, and Bill Conti.</p>

③ To return to Play mode, press **PLAY** while song is not being played.

* It is often convenient to check connections and volume while using ROM play.

Use the VOLUME slider to adjust the volume.

* The keyboard and Bender will not function during ROM play.

* The notes and other musical data being ROM played will not be transmitted from MIDI OUT.

To use the D - 70 to play songs as in ROM play, you will need separate MIDI sequencer.

3 PLAY THE D-70

When the D-70 is shipped, it contains 64 sounds (Performances). This section will explain how to play the preset sounds, select Performances, adjust the tuning, etc.

First, select the display that appeared immediately after the power was turned on. If a different display is shown, press **PLAY**.

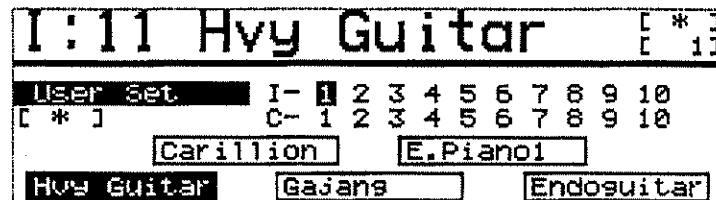

Play the keyboard. The first line of the display shows the sound (Performance) you are playing.

1. To Select a Performance

Now try selecting another Performance. There are two ways to select a Performance; you can assign (User Set) a desired Performance to a function key and then select it, or you can use the Performance List display.

■ Selecting a Performance from the User Set display

The User Set display (Play mode) will appear when the power is turned on.

The D-70 allows you to assign any desired Performance to each function button. A Performance can be assigned to each function button **F1**—**F5**, and this can be stored as a Group. Internal memory can store 10 Groups, for a total of 50 Performances. In addition, a separately sold RAM Card (M-256E) can also store 10 Groups (→P.36).

*Page 154 explains how to assign a Performance to a function button.

■ Selecting a Performance from the Performance List

The Performance List display will appear when you press **PERFORMANCE**.
 Internal memory contains 64 Performances, organized into 8 banks of 8 numbers.
 A separately sold RAM Card can also contain 64 Performances (☞ P.36).

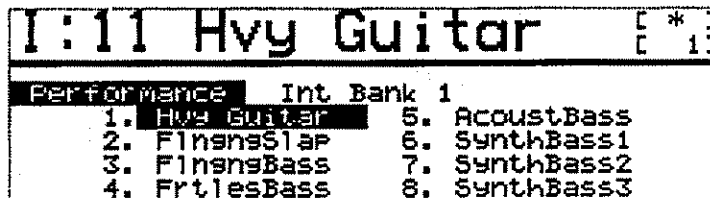

[Procedure]

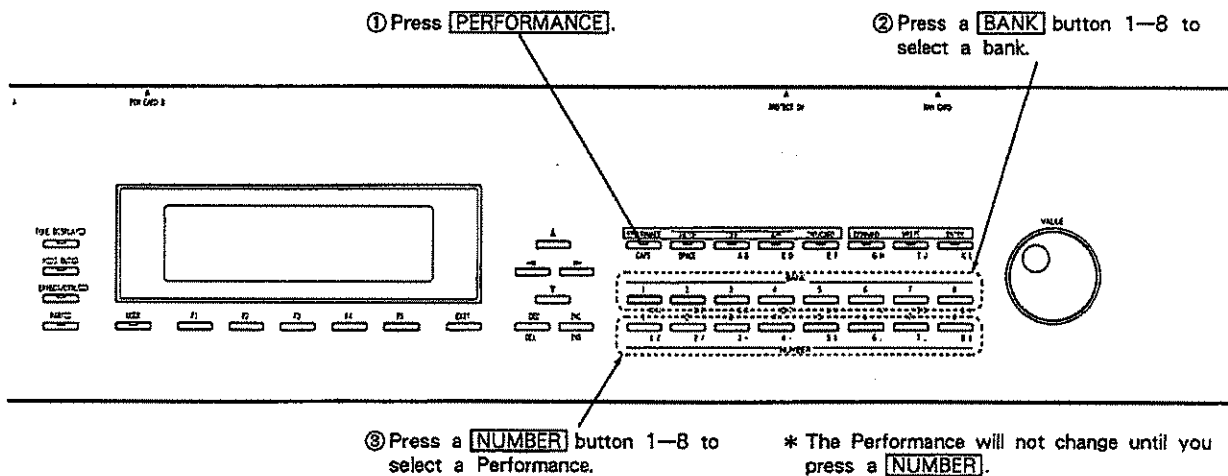

The display will show the selected Performance in inverse display.

- * Press **INT/CARD** to select the Internal (I) or RAM card (C) Performance List.
- * If a RAM card is not connected to the slot, the D-70 will not show the RAM card Performance List screen.
- * When you select a Performance on a RAM card, the indicator of **INT/CARD** will be lit.

To return to the Play display after selecting a Performance, press **PLAY** or **EXIT**

2. Try Out the Playing Functions

Play the D - 70 to try out the following playing functions.

■ Velocity

Volume or tone will change according to your playing dynamics (velocity). The effect of playing dynamics will depend on the settings of each Performance and Patch. (⇨ P.27, 30)

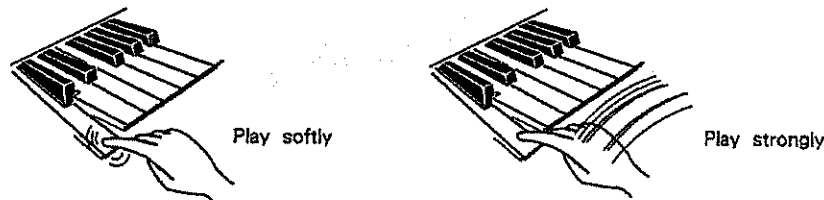

■ Aftertouch

After playing a note, you can press down more strongly to modify pitch, tone, volume, or vibrato. This is called "Aftertouch". Settings for each Performance will determine the effect of aftertouch. Refer to "Controllers" in chapter 2 (⇨ P.33).

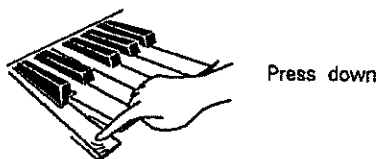

■ Bender / Modulation Lever

While playing a note, you can move the Bender/Modulation Lever to the left to lower the pitch, or to the right to raise the pitch. This will change the pitch smoothly, and can be used to express the fine nuances of pitch change that characterize many instruments. This also allows you to simultaneously control the tone, volume, vibrato, etc. of a sound. The result of moving the Bender/Modulation Lever to left or right will depend on the settings of each Performance. Refer to "Controllers" in chapter 2 (⇨ P.33).

While playing a note, you can push the Bender/Modulation Lever forward to simultaneously control pitch, tone, volume, vibrato, etc. The result of pushing the Bender/Modulation Lever forward will depend on the settings of each Performance. Refer to "Controllers" in chapter 2 (⇨ P.33).

*You can push the Bender/Modulation Lever forward while moving it to left or right. This offers many expressive possibilities such as changing the pitch while adding another effect.

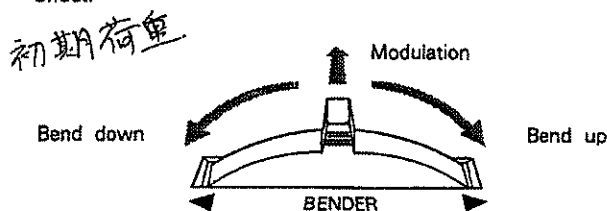

3. Master Tune

This adjusts the overall tuning of the D - 70 over a range of -64 — 0 — +63. A setting of 64 results in a pitch change of a half step (100 cents). (At a setting of 0, the A4 key will have a pitch of 440.0Hz.)

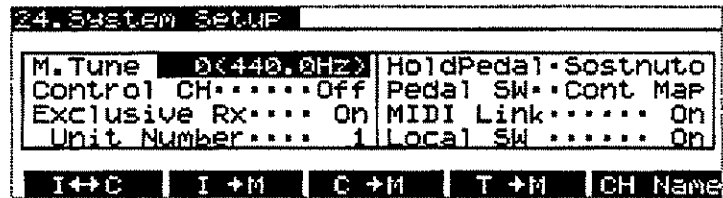

[Procedure]

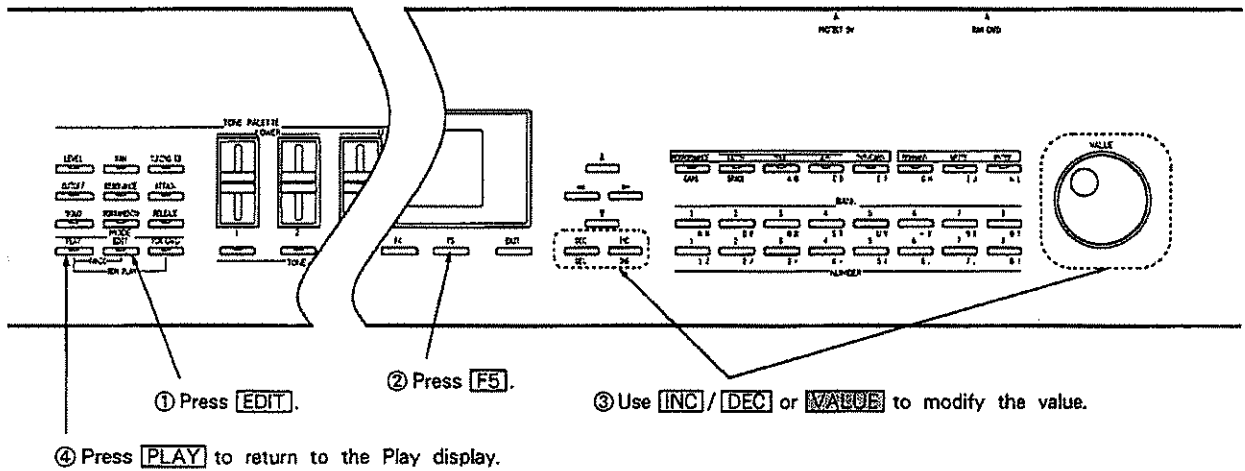

4. Adjust the Tone

Use the Brightness slider to change the tone.

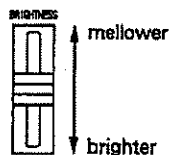

* The tone will be normal when the Brightness slider is at center position.

■ Tone Palette Sliders

The tone can also be edited using four Tone Palette sliders. For detailed explanation, see page 39.

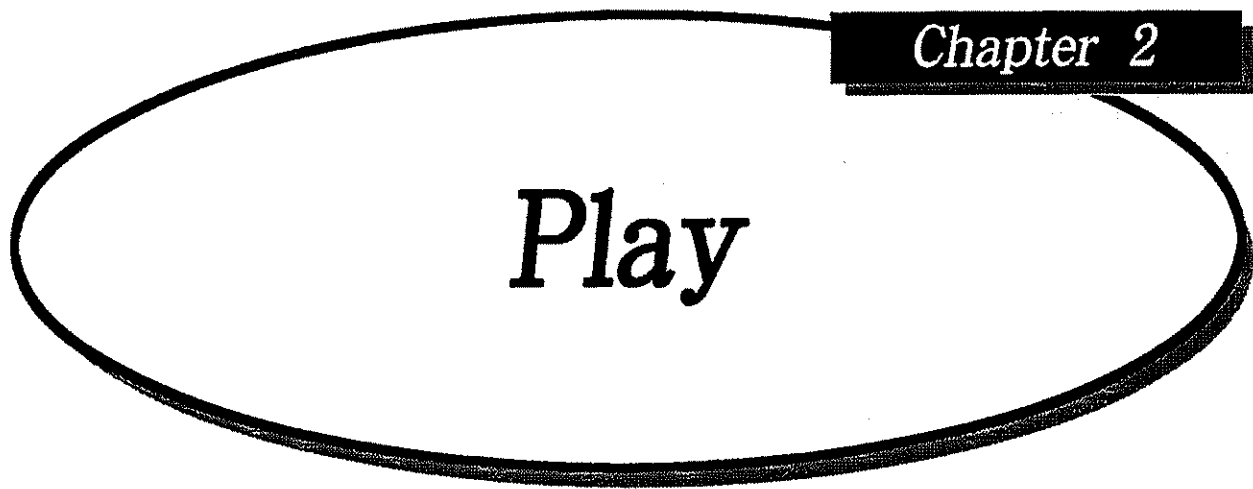

Play

1 GENERAL OVERVIEW

This section will give a general overview of the D - 70. Please read it before using Play mode.

1. How the D-70 is organized

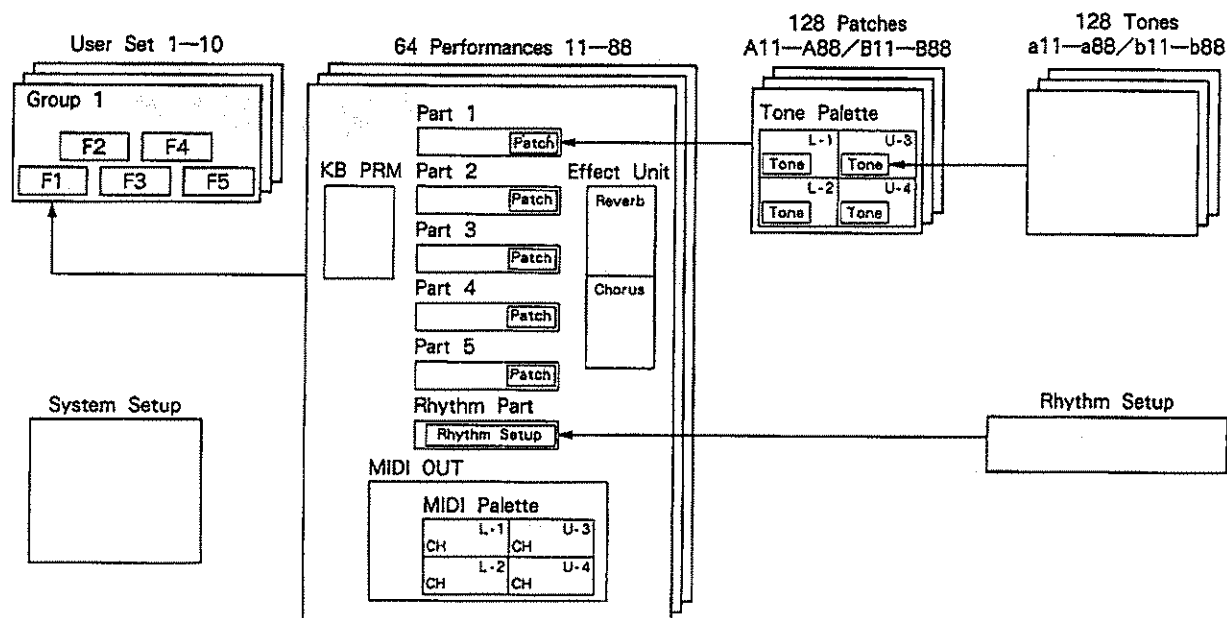

● Tone

A "Tone" is the basic unit from which a Patch is made. The 128 tones in internal memory are organized into Group (a/b), Bank (1 — 8), and Number (1 — 8).

● Tone Palette

A "Tone Palette" is an assignment of four Tones with parameters to determine how each Tone will sound. The Tone Palette is contained inside of a "Patch".

● Patch

A "Patch" is the unit of sound which you will play. It consists of a Tone Palette and parameters which determine how the Tone Palette will sound. Internal memory contains 128 Patches, organized into Group (A/B), Bank (1 — 8), and Number (1 — 8).

● Rhythm Setup

A "Rhythm Setup" is a combination of rhythm sounds and parameters which determine how each drum will sound. A sound can be freely specified for each key (note number).

● Part

The D-70 has five Synthe Parts (1 — 5) and a Rhythm Part. Each Part can be used as an independent sound module. A Patch can be assigned to each Synthe Part 1 — 5, and a Rhythm Setup can be assigned to the Rhythm Part. Parts are contained inside of a "Performance".

● MIDI Palette

A "MIDI Palette" consists of four MIDI channel assignments to play external MIDI sound sources, and parameters which determine how each MIDI channel will be played. The MIDI Palette is contained inside the MIDI OUT settings of a Performance.

-
- **Performance** A **Performance** consists of settings which determine how the D - 70 will perform. These settings assign a Patch to each Part, determine how the Parts will sound, determine how the effect unit (chorus,/reverb) will be used, and how the MIDI Palette of the MIDI OUT will play external MIDI devices. The internal memory of the D - 70 holds 64 Performances, organized into Banks (1 — 8) and Numbers 1 — 8.

 - **System Setup** This memory contains parameters such as Master Tune, which affect the entire D - 70.

 - **User Set** A “User Set” consists of settings which assign any desired one of the 128 Performances (Internal/RAM Card) to a function key. Assignments for five Performances are stored as a Group, and internal memory can store 10 Groups of User Sets.

■ Maximum simultaneous notes

The D - 70 can produce up to 30 voices at once. (Notes in their release stage are included in the number of simultaneously playable notes.) If more than 30 voices are requested, the Priority settings will determine which voices will sound (☞ P.67).

2. Patches

This section explains how a Tone Palette is organized, and the parameters (Patch parameters) which determine how the Tone Palette will function.

How a Tone Palette is organized

A Tone Palette is organized as follows.

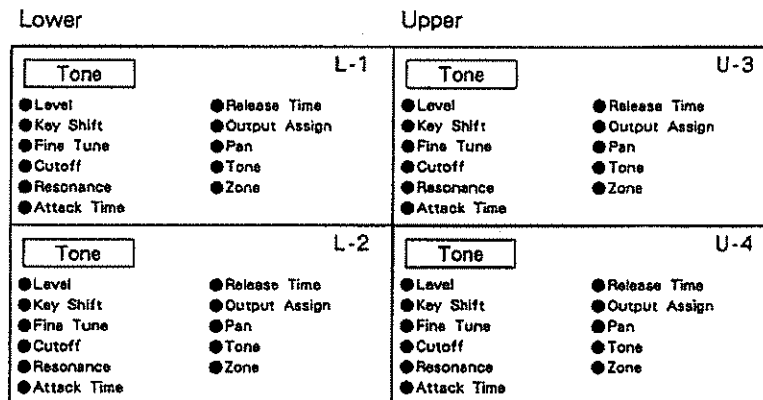

A Tone Palette is internally divided into four Sections.

- L-1: 1st Lower Tone
- L-2: 2nd Lower Tone
- U-3: 1st Upper Tone
- U-4: 2nd Upper Tone

Each Section is assigned a Tone, and parameter settings for Level, Pan, etc. determine how the tone will sound (P.53, 111).

Output Assign

This determines how the Tone of each Section will be output. Four types of output can be selected: Reverb, Chorus, Dry, and Direct (P.53, 60, 63).

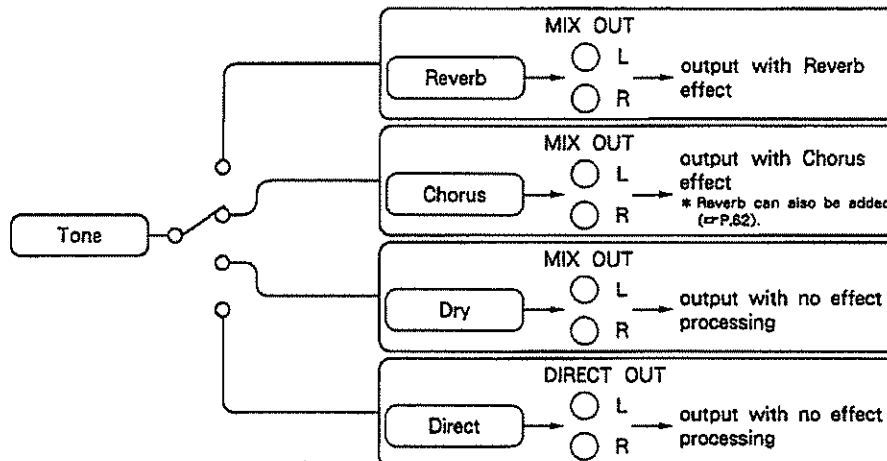

■ Patch parameters

The following parameters determine how each Section of the Tone Palette will function when played.

● Key Mode

This determines how the Tone of each Section is assigned to the keyboard. Three types of Key Mode are provided; Layer, Split, and Zone (☞ P.54, 57).

Layer : Tones of all Sections will sound across the entire keyboard range.
 * The keyboard range is C-1—G9 (note numbers 0—127).

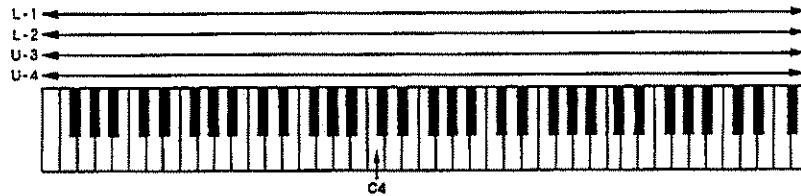

Split : The keyboard range will be split into Lower and Upper at the specified Split Point, and Tones will be assigned to each Section of Lower and Upper.

* Lower is C-1—Split Point (note number 0—Split Point)
 * Upper is next key of Split Point—G9 (next note number of Split Point—note number 127)

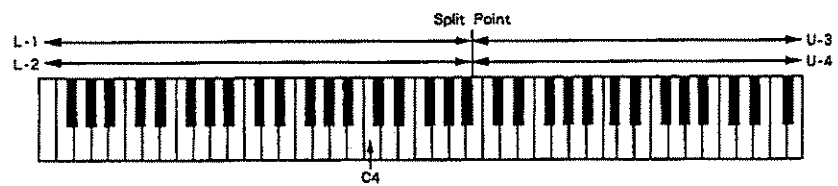

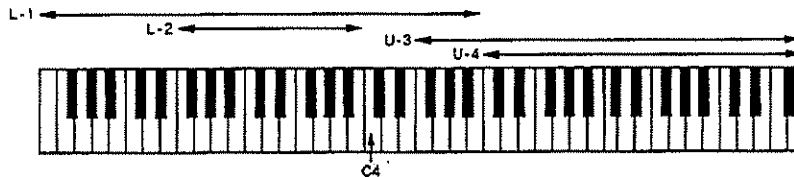

Zone : The keyboard range will be divided according to the Zone specified for each Section, with a Tone assigned to each Section.



● Velocity Mode and Threshold Sensitivity

These settings determine how velocity (playing dynamics) will switch between the 1st Tone and the 2nd Tone for each section, (Lower and Upper). Three types of Velocity Mode are provided; Normal, Switch, and Mix. The point at which the 1st Tone and the 2nd Tone are switched is determined by the Threshold Sensitivity (☞ P.56).

1st is indicated by 
 2nd is indicated by 

* These diagrams illustrate the Velocity Curve 1 (☞ P.107).

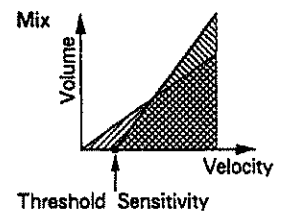
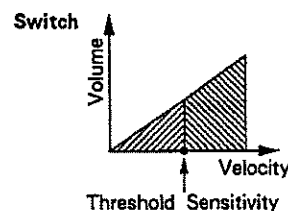
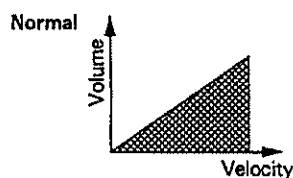

● Key Assign and Solo Legato

You can set Lower/Upper sections to Poly (chords) or Solo (single notes). When Solo is selected, you have the option of specifying Solo Legato (☞ P.53, 56).

Solo Legato: When you press another key before releasing the first, the new envelope will not attack, creating a seamless transition to the new note.

* The PCM Wave will be read from the beginning.

* Depending on the TVF and TVA settings (☞ P.118, 124), the result may not sound legato.

Normal (Solo): Regardless of how you play, each note will start its envelope from the beginning, so that each note will have the specified pattern of change in Volume and Tone over time.

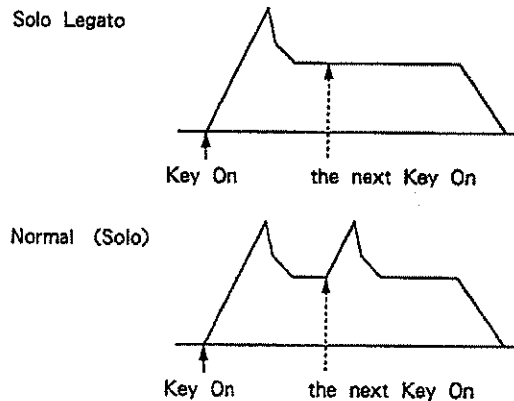

* If two or more keys are pressed simultaneously while Solo is selected, the last-pressed key will sound (last note priority).

● Portamento

When the Key Assign is Solo, you can use Portamento on Lower/Upper sections.

When Portamento is used (turned On), the pitch will smoothly change from one note to the next.

Two types of Portamento are provided; Auto and Normal.

Auto: Portamento will be applied if you press a key while holding the previous key. If you completely release the previous key before pressing the next key, Portamento will not be applied. This allows you to selectively use Portamento according to your keyboard playing.

Normal: Portamento will be applied regardless of how you play.

The Portamento Mode setting determines whether Auto or Normal Portamento is used. The speed of the Portamento effect is determined by the Portamento Time parameter (☞ P.57).

* Portamento can be used only when Key Assign is set to Solo.

3. Performance

The general concept of a Performance has been explained on page 24. Here we will explain about the MIDI Palette, and the parameters (Performance parameters) which determine how the MIDI Palette will function.

■ How a MIDI Palette is organized

A MIDI Palette is organized as follows.

Lower		Upper	
MIDI Channel	L-1	MIDI Channel	U-3
MIDI Volume		MIDI Volume	
Program Change Number		Program Change Number	
Transpose		Transpose	
Zone		Zone	
MIDI		MIDI	
MIDI Channel	L-2	MIDI Channel	U-4
MIDI Volume		MIDI Volume	
Program Change Number		Program Change Number	
Transpose		Transpose	
Zone		Zone	
MIDI		MIDI	

A MIDI Palette is internally divided into four Sections.

- L - 1: 1st Lower Channel
- L - 2: 2nd Lower Channel
- U - 3: 1st Upper Channel
- U - 4: 2nd Upper Channel

Each Section is assigned its own MIDI Channel, and parameter settings for Program Change Number, MIDI Volume, etc., to determine how external MIDI sound sources will be played. Each Section will transmit MIDI messages to external MIDI sound sources on its own MIDI Channel (⇨ P.68).

■ Performance parameters

The following MIDI OUT parameters determine how each Section of the MIDI Palette will function when you play the D - 70.

● Key Mode

This determines how the MIDI Channel of each Section will be assigned to the keyboard. Three types of Key Mode are provided; Layer, Split, and Zone (☞ P.69).

Layer : MIDI Channel of all Sections will sound across the entire keyboard range.
 * The keyboard range is C-1—G9 (note numbers 0—127).

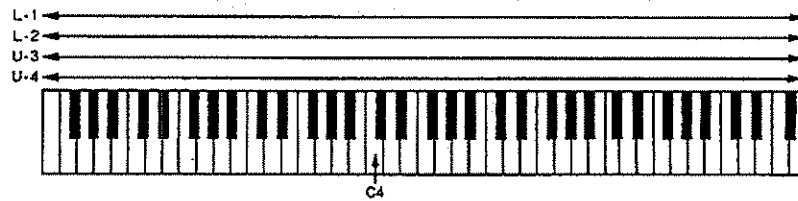

Split : The keyboard range will be split into Lower and Upper at the specified Split Point, and MIDI Channels will be assigned to each Section of Lower and Upper.
 * Lower is C-1—Split Point (note number 0—Split Point)
 * Upper is next key of Split Point—G9 (next note number of Split Point—note number 127)

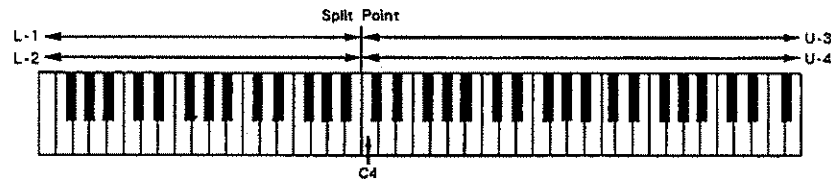

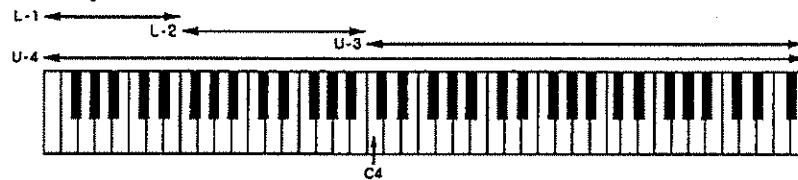

Zone : The keyboard range will be divided according to the Zone specified for each Section, with a MIDI Channel assigned to each Section.



● Velocity Mode and Threshold Sensitivity

These settings determine how velocity (playing dynamics) will switch between the 1st Channel and the 2nd Channel for each section (Lower and Upper). Three types of Velocity Mode are provided; Normal, Switch, and Mix. The point at which the 1st Channel and the 2nd Channel are switched is determined by the Threshold Sensitivity (☞ P.68).

1st is indicated by 
 2nd is indicated by 

* These diagrams illustrate the Velocity Curve 1 (☞ P.102).

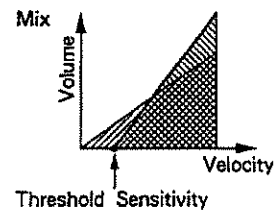
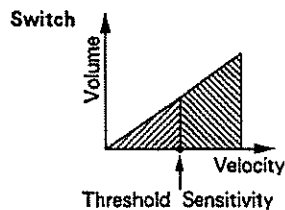
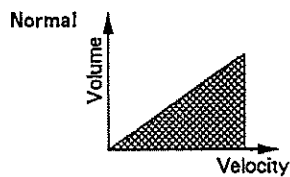

4. Key Mode and Zone

This section explains the function of Key Mode and Zone.

■ Each Part has a Zone

Each Synthe Part (1 — 5) to which a Patch is assigned can be given a Zone, which is independent of the Key Mode of the Patch (⇨ P.66). In this case, the Zone of the Part and the Key Mode of the Patch will be related as follows.

Key Mode = Layer

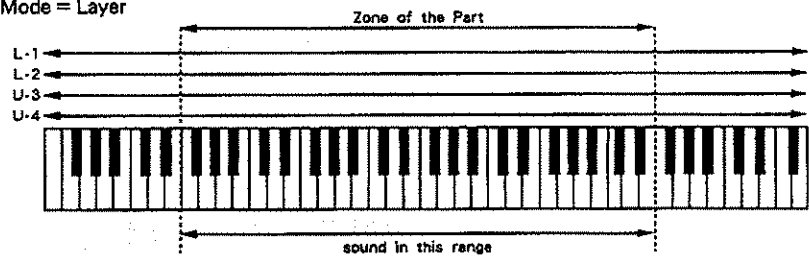

Key Mode = Split

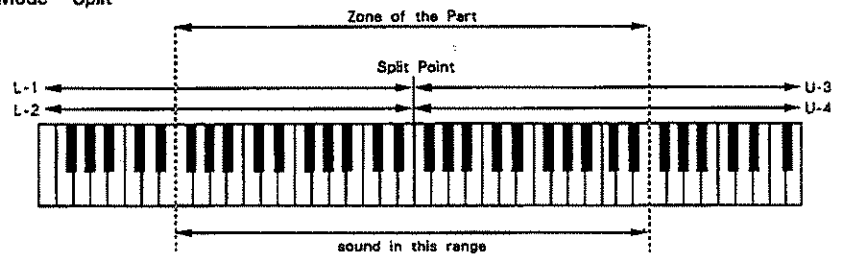

Key Mode = Zone

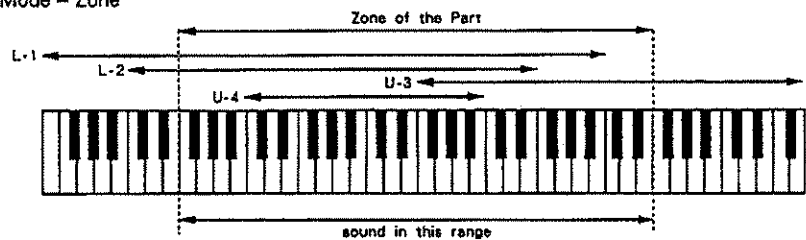

The keyboard area in which the specified Key Mode overlaps with the Zone of the Part will sound, and the keyboard area over which they do not overlap will not sound. By setting the Zone of a Part, you can mute an area for which you do not want sound to be produced.

The Rhythm Part also has a Zone setting, and will sound only within its specified Zone. Also, a Rhythm Setup has a Rhythm Shift (⇨ P.136) parameter which can be used together with the Zone to mute an area in which you do not want sound.

■ Key Mode and Zone

The area in which the keyboard will play the sounds of the D - 70 (internal) is determined by the combination of two settings; the Key Mode of the Patch and the Zone of the Part. At the same time, note messages will be transmitted from MIDI OUT as determined by the MIDI OUT Key Mode settings of the Performance.

The Key Mode and Zone can be used together in various ways. For example when playing the D - 70 together with external MIDI sound sources, you can make different areas of the keyboard play different combinations of sounds; the D - 70 alone, the MIDI sound source alone, or the D - 70 and the MIDI sound source.

Set the Key Mode of the Patch and MIDI OUT to Zone.

Solid lines indicate Patch Zones

Dashed lines indicate MIDI OUT Zones

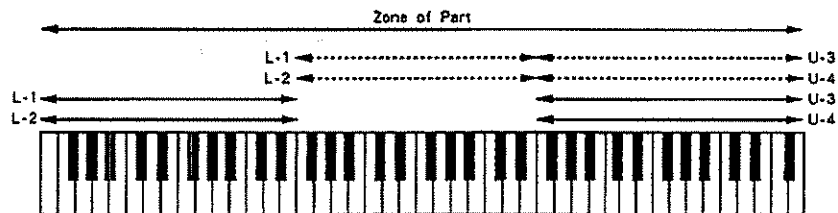

By turning the KB PART (the Part played by the keyboard) Off and making appropriate Key Mode settings for the MIDI OUT of the Performance, you can use the D - 70 as a MIDI keyboard controller (P.67).

5. Controllers

Using controllers will help your playing be more musically expressive. In this section we will explain controller settings.

Types of controller

The D - 70 is able to use the following controllers. Each can be set for the D - 70 itself (internal) and for MIDI OUT.

Bender	move the Bender/Modulation Lever to left or right
Aftertouch	after playing a key, press harder
Modulation	push the Bender/Modulation Lever forward
C1 Slider/Expression Pedal	move the C1 Slider/press an EV - 5 or EV - 10 (sold separately)
Pedal Switch	Press a separately sold FS - 1 or FS - 5L (latch-type) or DP - 2, DP - 6, FS - 5U (unlatch-type)
Hold Pedal	Press a separately sold DP - 2, DP - 6, FS - 5U (unlatch-type)

Latch-type switches will be On from the time you press and release the pedal, to when you press it again.

Unlatch-type switches will be On from the time you press the pedal to when you release it.

Latch-type
(FS - 1, FS - 5L)

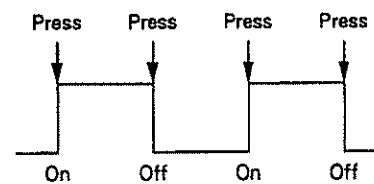

Unlatch-type
(DP - 2, DP - 6, FS - 5U)

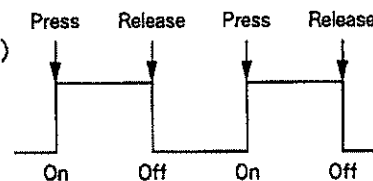

The Controller Map

For each controller, you can specify two Functions, the Value (range of effect), and the Destination (key area).

These settings are part of the Controller Map.

- Function: select the function to be controlled
- Value: specify the range of the effect (cannot be specified for Pedal SW, Hold Pedal, or MIDI OUT)
- Destination: select the key area to which the effect will apply

The Destination determines the range (Lower or Upper) of the Tone Palette and MIDI Palette.

- Lower: the controller will affect L - 1 and L - 2
- Upper: the controller will affect U - 3 and U - 4
- Both: the controller will affect L - 1 — U - 4
- Off: the controller will have no effect.

Example of Controller Map settings

Function	Value	Destination
Pitch Bend	+ 2 semi	Lower
TVF Cutoff	80	Upper

Aftertouch (key pressure) will take effect as specified by two Controller Maps; the Internal Aftertouch Controller Map and the MIDI OUT Aftertouch Controller Map.

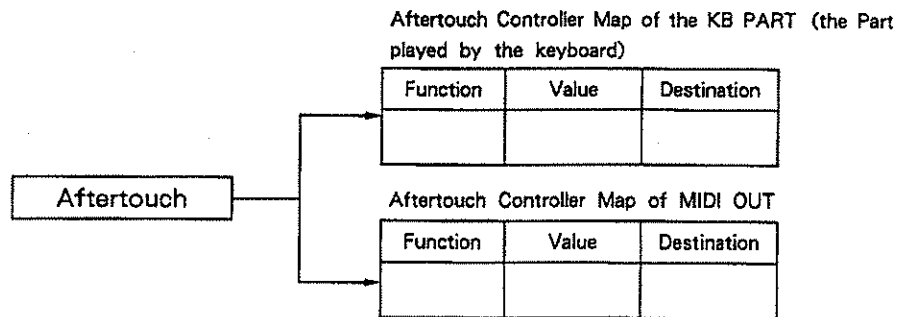

Internal Controller settings

The KB PRM and each Synthe Part (Parts 1 — 5) in a Performance has its own Controller Map. (The Rhythm Part does not have a Controller Map.)

For the KB PRM, you may specify the CI Slider/Expression Pedal and Pedal Switch as controllers (☞ P.64, 96).

For each Synthe Part (Parts 1 — 5), you may specify Bender, Aftertouch, Modulation, and Hold Pedal as controllers (☞ P.64, 99).

Controller settings for MIDI OUT

The MIDI OUT of a Performance has its own Controller Map which allows you to specify Bender, Aftertouch, Modulation, CI Slider/Expression Pedal, Pedal Switch, and Hold Pedal as controllers (☞ P.71, 103).

6. Signal Flow

This section explains the signal flow from when you play the keyboard to when sound is produced, and the flow of MIDI data.

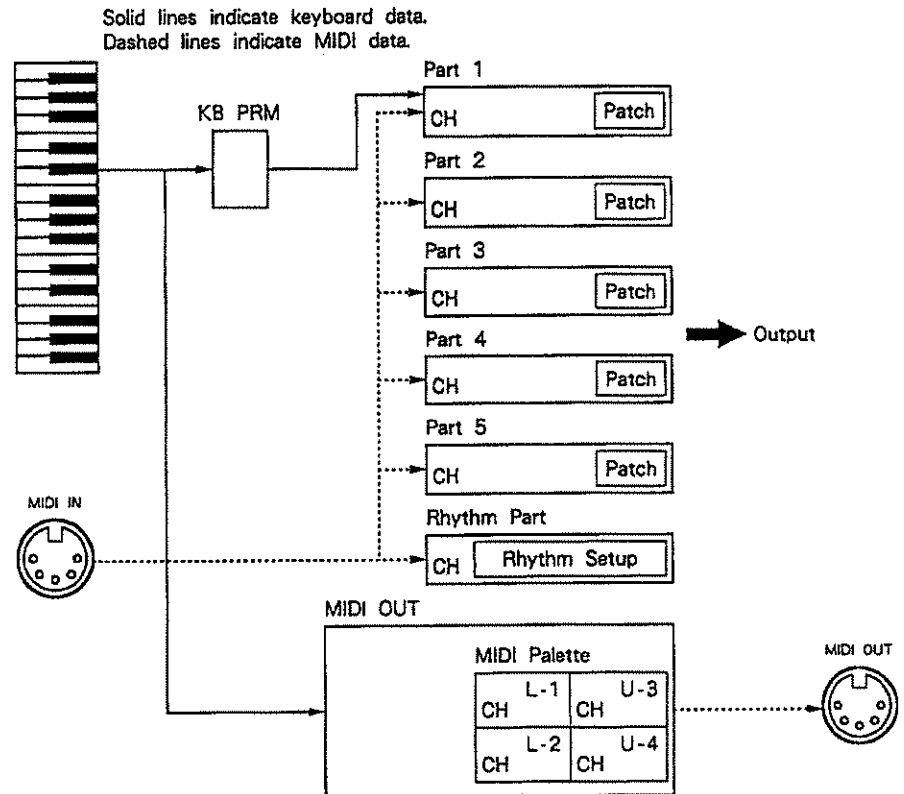

■ Keyboard data flow

The keyboard is directly connected either to a Synthe Part (1 — 5) or to the Rhythm Part, and will play the Patch assigned to that Part (or if connected to the Rhythm Part, will play the Rhythm Setup). The KB PART setting for KB PRM determines which Part will be played by the keyboard (⇨ P.67).

Data from the keyboard is turned into MIDI messages by the MIDI Palette, and is transmitted from MIDI OUT. The Key Mode, Velocity Mode, and MIDI Palette settings will determine how messages are transmitted from MIDI OUT (⇨ P.68, 104).

■ MIDI data flow

Each Part has its own MIDI Channel on which it will receive MIDI data. Out of the MIDI messages input at MIDI IN, each Part will receive the Note messages of its own Channel.

The KB PART (the Part played by the keyboard) will be played both by the keyboard and by MIDI messages.

In addition to the MIDI Channel of each Part, you can specify a Control Channel on which the entire Performance will be controlled (⇨ P.137).

Incoming MIDI Program Change messages on the Control Channel can select Performances (⇨ P.49).

7. RAM Card Data

A separately sold RAM Card (M - 256E) can also store User Set, Performance, Patch, Tone, Rhythm Setup and System Setup data (→ P.139).

Internal		RAM card	
User Set	10	User Set	10
Performance	64	Performance	64
Patch	128	Patch	128
Tone	128	Tone	128
Rhythm Setup	1	Rhythm Setup	1
System Setup	1	System Setup	1

Performances both on a RAM card and in the Internal memory can be registered to a User Set Group. However, it is not possible to use a combination of RAM and Internal data for Performances, Patches and Tones. In other words, if a RAM card Performance is selected, only Patches and Tones on the RAM card can be used. If an Internal Performance is selected, only Patches and Tones in the Internal memory can be used.

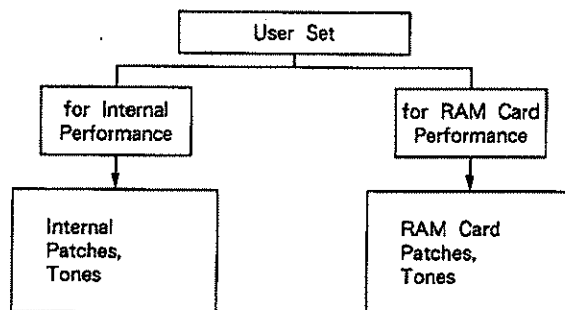

*While playing, the Rhythm Setup and System Setup data from Internal memory are always used. The Rhythm Setup and System Setup data in a RAM Card are only for storage, not for immediate use.

When you select a RAM Card Performance, the **INT/CARD** indicator will light, indicating which data (Internal or RAM Card) is being used. The display will indicate as follows whether Internal or RAM Card data is being used.

(Example) For Performance

Internal → I:11
 RAM Card → C:11

*For detailed explanation on Performance selection, see pages 17 and 44.

2 BASIC OPERATION (PLAY MODE)

The D-70 allows you to modify settings (the way in which sounds are combined, sound editing, etc.) even while playing. This section explains the basic procedures in Play mode.

1. How to View the Screen

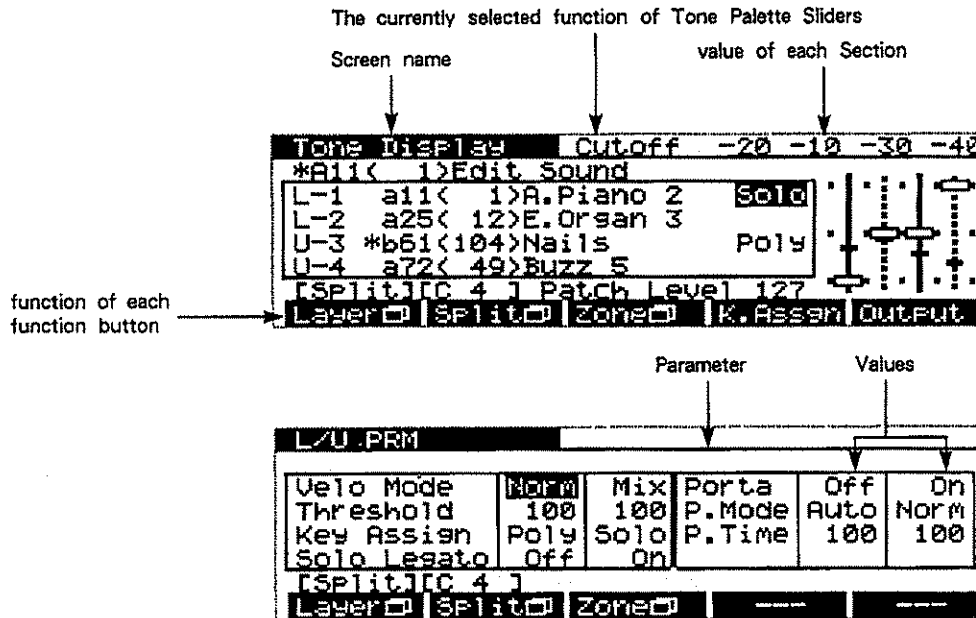

■ The function buttons

Each of the function buttons located below the display has more than one function. The lower line of the display will indicate the current function of each button.

● Select Performances

In the User Set display, the function buttons will select Performances.

● Set a value using Layer, Split, Zone, etc.

The function buttons will set a value for the parameters shown in the display

● Select a List using Page ↑, Page ↓, etc.

The function buttons will switch the displayed list

● Select Parameters using Layer, K.Assgn, Output, etc.

The function buttons will switch the screen to other parameters

*Some of the functions of the function buttons will be displayed with a mark. This indicates that a different display or parameter will be selected each time you press the button.

2. How to Select Displays

Play mode contains several displays. To select a display, press the corresponding button, as explained below.

* If the **PLAY** indicator is not lit, press **PLAY**.

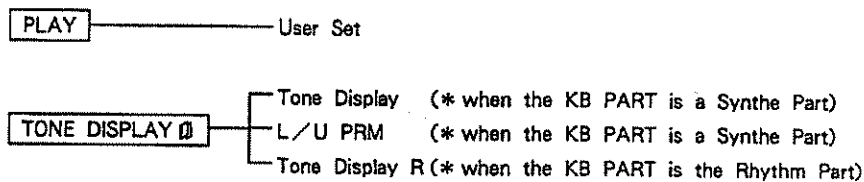

* If the KB PART is Off, pressing **TONE DISPLAY** [] will not open the window.

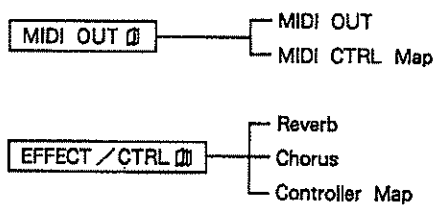

* If the KB PART is Rhythm Part or Off, the "Controller Map" window cannot be opened.









Each time you press **TONE DISPLAY** [], **MIDI OUT** [], **EFFECT / CTRL** [], or **PART** [], the display will change. The [] and [] marks indicate the number of the display.

3. How to Modify Settings

Here's how to modify the settings of the parameters (functions) shown in the display.

■ Basic procedure to modify settings

Use /// to place the cursor on the parameter you wish to modify, and use / or  to modify the value. The cursor selection is indicated in inverse display.

* There will be no cursor in the Tone Display R display.



Some displays contain items which cannot be selected by the cursor (to which the cursor cannot be moved).

- Items to be set using the Function buttons. (Refer to P.52, "③ FUNCTIONS OF EACH DISPLAY (PLAY MODE)".)
- Items to be set using the Tone Palette Sliders.
- Selecting a Performance, Patch, or Tone.
- Transmitting a Program Change Number.

To modify settings for these items, refer to the following explanations.

■ To use the Tone Palette Sliders

Here's how to make parameter settings for the Tone Palette, MIDI Palette, and Effects unit. The parameters to be edited will be different for each display.

Display	Parameters to edit
User Set	Tone Palette parameters
Tone Display	* Use the Tone Palette buttons to select a parameter. (Level, Pan, Key Shift, Fine Tune, Cutoff, Resonance, Attack Time, Release Time)
L/U PRM	
Controller Map	
Part PRM 1	* If the KB PART is the Rhythm Part, edit the Output Level of the Rhythm Part.
Part PRM 2	
Tone Display R	Output Level of the Rhythm Part
MIDI OUT	MIDI Palette parameters
MIDI CTRL Map	* Use the Tone Palette buttons  (MIDI Volume) and  (Transpose) to select a parameter.
Reverb	Reverb parameters (Level, Type, Time, Feedback)
Chorus	Chorus parameters (Level, Rate, Depth, Feedback) * Only parameters in the left side of the display.

● To edit Tone Palette parameters

Press **TONE DISPLAY** to get the Tone Display screen.

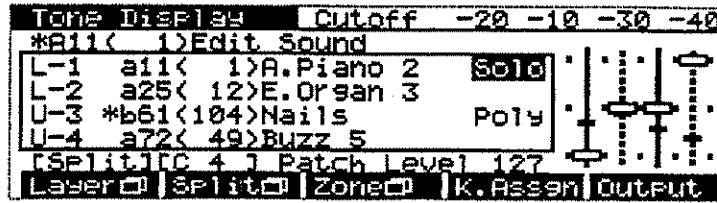

Tone Palette Sliders 1 — 4 correspond to each Section (L-1 — U-4).

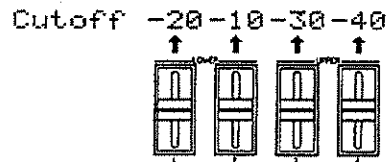

The upper right of the display shows the parameter which you will be editing using the Tone Palette Sliders, and the value of each Section.

Use the Tone Palette Buttons to select the parameter to be edited by the Tone Palette Sliders. The indicator of the selected button will light.

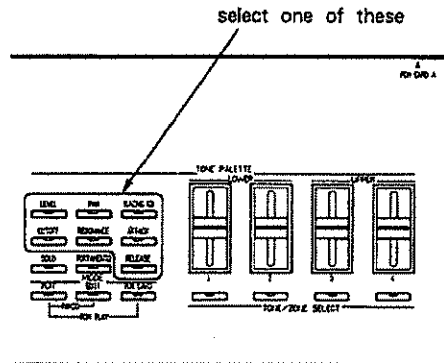

- * Each time you press **TUNING**, the parameter will alternate between K.Shift (Key Shift) and F.Tune (Fine Tune).
- * If the KB PART has been set to Rhythm, the Tone Palette Sliders will be able to edit only the Level parameter (Output Level of the Rhythm Part). Tone Palette Slider 1 will be used.
- * If the KB PART is set Off, the Tone Palette Sliders cannot be used for editing.

★ Notes concerning slider operation

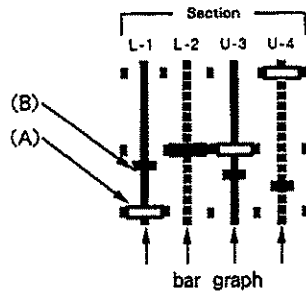

The screen will graphically indicate the Tone Palette Slider position (A) and the parameter value (B). To change the parameter value, you must first move (A) to the position of (B), and then move the Tone Palette Slider.

A dotted bar graph line indicates that the sound of that Section has been muted. (☞ P.43, 113)

* The Tone Palette Sliders will have the same function even in screens where there is no graphic display.

● To edit MIDI Palette parameters

Press **MIDI OUT** to get the MIDI OUT display.

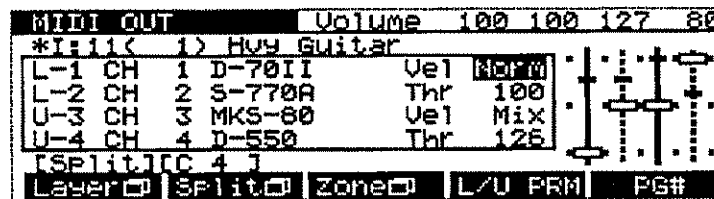

* In this display, internal Tones cannot be controlled.

Tone Palette Sliders 1 — 4 correspond to each Section (L-1 — U-4).

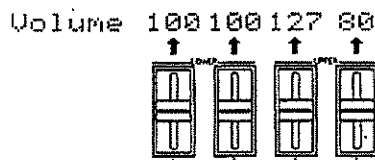

The upper right of the display shows the parameter which you will be editing using the Tone Palette Sliders, and the value of each Section.

Use the Tone Palette Buttons to select the parameters to be edited by the Tone Palette Sliders. In the MIDI Palette, you can select the **LEVEL** (MIDI Volume) and **TUNING** (Transpose) parameters. The indicator of the selected button will light.

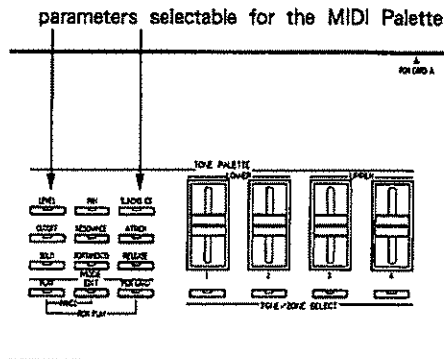

★ Note concerning slider operation

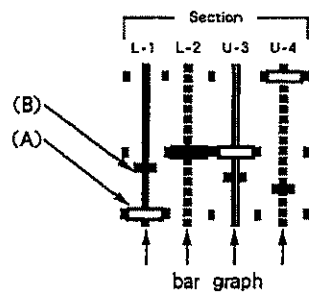

The screen will graphically indicate the Tone Palette Slider position (A) and the parameter value (B). To change the parameter value, you must first move (A) to the position of (B), and then move the Tone Palette Slider.

A dotted bar graph line indicates that the MIDI Channel of that Section has been muted. (P.44, 104)

★ Tone Palette Sliders can be used to edit MIDI Palette parameters in the "MIDI CTRL Map" display as well. (The Tone Palette Sliders will have the same function.)

● To edit the Effect parameters

In the Reverb and Chorus display selected by pressing **EFFECT / CTRL**, the Tone Palette Sliders will edit Effect Unit parameters. For details refer to P.59 and P.63.

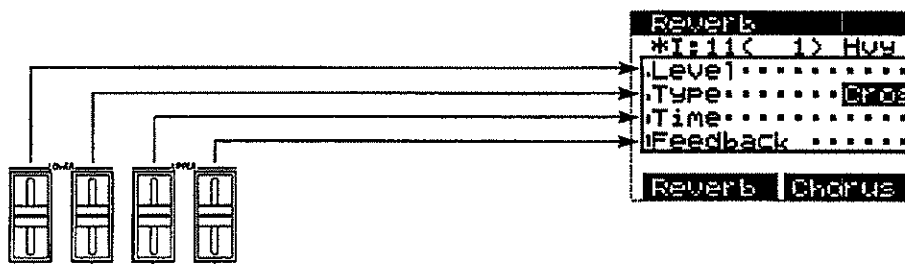

■ To use **TONE/ZONE SELECT**

TONE/ZONE SELECT can be used as follows.

● For each Section of the Tone Palette: mute a Tone, select a Tone, set a Zone, make settings for Output Assign.

● For each Section of the MIDI Palette: mute a MIDI Channel, output a Program Change Number, set a Zone.

TONE/ZONE SELECT 1 — 4 correspond to each Section (L - 1 — U - 4) of the Tone Palette and MIDI Palette.

* Do not simultaneously press two or more **TONE/ZONE SELECT** s.

● To mute a Tone

In Play mode displays other than MIDI OUT or MIDI CTRL Map, you can mute the Tone of each Section.

Press the **TONE/ZONE SELECT** for the Section whose Tone you wish to mute. When muted, the indicator of the button will go out.

* If the KB PART setting is Rhythm or Off, Tones cannot be muted.

● To select a Tone

In Play mode displays other than MIDI OUT or MIDI CTRL Map, you can select a Tone for each Section (⇐ P.45).

● Zone settings for a Tone

In Play mode displays other than MIDI OUT or MIDI CTRL Map, you can set the Zone for the Tone of each Section.

While pressing the desired **TONE/ZONE SELECT**, press two keys to specify the Zone of that Section. After specifying the Zone for each Tone, release the button. The Zone will be determined by the last two keys pressed.

* If you press two keys at the same time, the Zone may not be set.

* If the KB PART setting is Rhythm or Off, it is not possible to make Zone settings.

* The Zone you specify for each Section is effective only when the Patch parameter Key Mode is set to Zone.

● Output Assign settings

In the Reverb and Chorus displays, you can make Output Assign settings for each Section.

While pressing the desired **TONE/ZONE SELECT**, press **F1** — **F4** to specify the Output Assign for that Section.

Output Assign: **F1** → Reverb, **F2** → Chorus, **F3** → Dry, **F4** → Direct

● To mute a MIDI Channel

In the MIDI OUT or MIDI CTRL Map display, you can mute the MIDI Channel of each Section. Press the **TONE/ZONE SELECT** for the Section whose MIDI Channel you wish to mute. When muted, the indicator of the button will go out.

*When the MIDI Channel is muted, no MIDI messages will be transmitted.

● To output a Program Change message

In the MIDI OUT or MIDI CTRL Map displays, you can transmit a MIDI Program Change message (P.46).

● Zone settings for a MIDI Channel

In the MIDI OUT or MIDI CTRL Map display, you can set the Zone for the MIDI Channel of each Section. While pressing the desired **TONE/ZONE SELECT**, press two keys to specify the Zone of that Section. After specifying the Zone for the MIDI channel, release the button. The Zone will be determined by the last two keys pressed.

*If you press two keys at the same time, the Zone may not be set.
 *The Zone you specify for each Section is effective only when the Performance parameter MIDI OUT Key Mode is set to Zone.

■ To select a Performance, Patch, or Tone

To select a Performance, Patch, or Tone, use the List display for each type of data.

● To select a Performance

Press **PERFORMANCE** to get the Performance list display. Press **INT/CARD**, **BANK** and **NUMBER** to select the Bank and Number. Be sure to press **NUMBER** last. To return to the previous display, press **EXIT**.

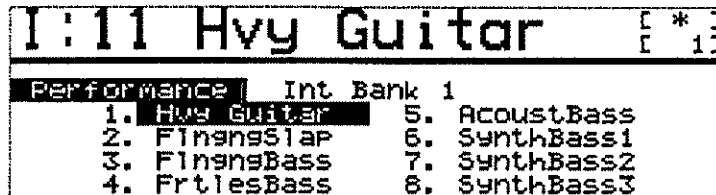

*If you are in the Jump, Write or Command display, pressing **PERFORMANCE** will not enter the List display. You must first press **EXIT**, and then press **PERFORMANCE**.
 *When you select a Performance on a RAM card, the indicator of **INT/CARD** will be lit.

《The meaning of the [] display》

[*]: The currently selected Performance has been edited, but not written.
 [1]: The decimal number of the currently selected Performance (this corresponds to the Program Change Number)

● To select a Patch

Press **[PATCH]** to get the Patch List display. Press **[A/B]**, **[BANK]**, and **[NUMBER]** to select the Group, Bank, and Number. Be sure to press **[NUMBER]** last. To return to the previous display, press **[EXIT]**.

I:A11 A.Piano		[*]
		[1]
Patch	A Bank 1	
1. A.Piano	5. Soundtrck3	
2. Fantasia	6. Hvy Guitar	
3. Soundtrck1	7. Power Brass	
4. Soundtrck2	8. Marimba	

*If you are in the Jump, Write or Command display, pressing **[PATCH]** will not enter the List display. You must first press **[EXIT]**, and then press **[PATCH]**.

《The meaning of the [] display》

[*] : The currently selected Patch has been edited, but not written.

[1] : The decimal number of the currently selected Patch (this corresponds to the Program Change Number)

*If the KB PART is set to Rhythm or Off, this List display cannot be opened, and it will not be possible to select Patches.

● To select a Tone

[TONE/ZONE SELECT] 1 — 4 correspond to each Section (L-1 — U-4) of the Tone Palette.

From Play displays other than MIDI OUT and MIDI CTRL Map, press **[TONE]** while pressing the desired **[TONE/ZONE SELECT]**, and the Tone List display for the selected Section will appear.

Press **[A/B]**, **[BANK]**, and **[NUMBER]** to select a Tone. Be sure to press **[NUMBER]** last. To return to the previous display, press **[EXIT]**.

*Do not press two or more **[TONE/ZONE SELECT]**s simultaneously.

I:a11 A.Piano 1		[*]
		[1]
		[L-1]
Tone	a Bank 1	
1. A.Piano 1	5. A.Piano 5	
2. A.Piano 2	6. A.Piano 6	
3. A.Piano 3	7. A.Piano 7	
4. A.Piano 4	8. A.Piano 8	

*If you are in the Jump, Write or Command display, pressing **[TONE]** while holding **[TONE/ZONE SELECT]** will not enter the List display.

You must first press **[EXIT]** to return to the previous display, and then press **[TONE]** while holding **[TONE/ZONE SELECT]**.

《The meaning of the [] display》

[*] : The currently selected Tone has been edited, but not written.

[1] : The decimal number of the currently selected Tone.

[L - 1] : The selected Section.

*If the KB PART is set to Rhythm or Off, this List display cannot be opened, and it will not be possible to select Tones.

*From the MIDI OUT or MIDI CTRL Map displays, the Tone List display will not be opened. Instead, the Program Change Number List display will appear.

■ To transmit a Program Change message

[TONE/ZONE SELECT] 1 — 4 correspond to each Section of the MIDI Palette (L - 1 — U - 4).

From the MIDI OUT or MIDI CTRL Map displays, you can press [TONE] while holding [TONE/ZONE SELECT] to get the Program Change Number List display for the specified Section. This function allows you to immediately transmit any desired MIDI Program Change message on the channel of the selected Section.

*Do not press two or more [TONE/ZONE SELECT] s simultaneously.

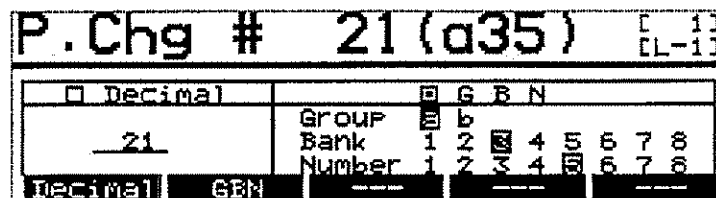

*If you are in the Jump, Write or Command display, pressing [TONE] while holding [TONE/ZONE SELECT] will not enter the List display.

You must press [EXIT] to return to the previous display, and then press [TONE] while holding [TONE/ZONE SELECT].

《The meaning of the [] display》

[1] : The MIDI Channel of the currently selected Section.

[L - 1] : The selected Section.

There are two methods of specifying a Program Change Number; using the numeric keypad to directly specify the Program Change Number, or using the [A/B], [BANK], [NUMBER] (Group/Bank/Number) (the GBN method).

To use the numeric keypad to directly specify the Program Change Number, press [F1] [Decimal]. Be sure to press [ENTER] after you enter the number.

To use [A/B], [BANK], and [NUMBER] (the GBN method) to specify the Program Change Number, press [F2] [GBN]. Be sure to press [NUMBER] last.

The  mark indicates the method by which Program Change Numbers can be entered.

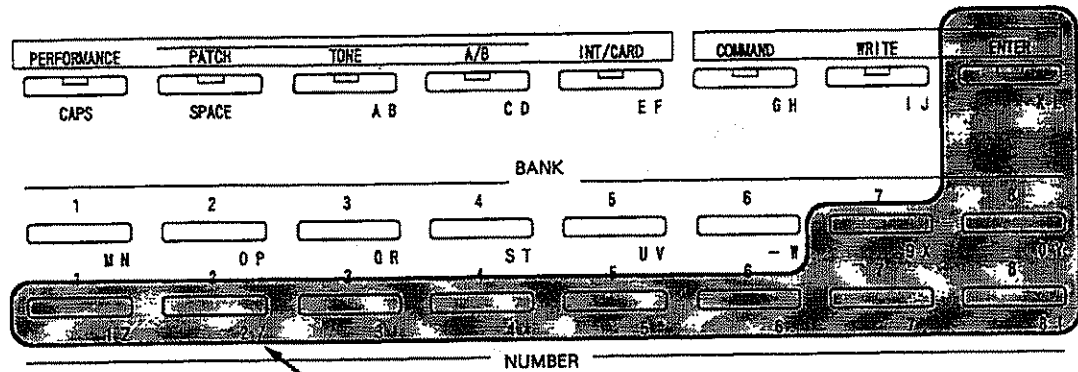

The buttons in the shaded area can be used as a numeric keypad.

To return to the previous display, press **EXIT**.

The Program Change data transmitted via MIDI is in the range of 0 — 127, but in for this function, you will specify a value of 1 — 128 (a11 — b88). If you use the numeric keypad to specify a value of 0, no message will be transmitted.

■ How to use **SOLO** and **PORTAMENTO**

You can switch Solo or Portamento settings simultaneously for both Upper and Lower (⇐ P.28).

* To set Solo or Portamento independently for Upper and Lower, refer to page 56.

SOLO

When you press **SOLO**, the Key Assign (Poly, Solo) for both Upper and Lower will be given the same setting. Each time you press this button, Key Assign will alternate between Poly and Solo. When set to Solo, the **SOLO** indicator will light.

* It is not possible to switch between Poly and Solo if the KB PART setting is Rhythm or Off.

PORTAMENTO

When you press **PORTAMENTO**, the Portamento (On, Off) for both Upper and Lower will be given the same setting. Each time you press this button, the Portamento setting will alternate between On and Off. When the Key Assign is Solo and Portamento is On, the **PORTAMENTO** indicator will light.

* It is not possible to switch Portamento On/Off if the KB PART setting is Rhythm or Off.

4. RAM Card

Data can be written to and read from a RAM Card (M - 256E, sold separately). Data stored in a RAM Card can be modified as many times as you wish. This allows you to store edited Performances, Patches, and Tones etc.

*When using a new RAM Card (M - 256E) for the first time, you must Format the card before it can be used. When you execute the Format command, all D - 70 data will be copied onto the card (⇨ P.140).

Formatting is also necessary when you wish to use a card that has been used by other devices to store D - 70 data.

*RAM Card for other D-series devices (D - 5/10/20/50/110/550) cannot be used, nor can sound library ROM Cards (PN - D10 series, PN - D50 series) be used.

*RAM Cards contains a battery to back up the memory data. Before using a RAM Card, be sure to install the battery as explained in the manual for the RAM Card.

*Before transporting the D - 70, be sure to remove the RAM Card.

■ How to insert a RAM Card

RAM Cards must be inserted into the RAM Card slot on the rear panel. Make sure that the correct side is facing up, and that the card is pointing in the correct direction. Then insert it all the way into the slot.

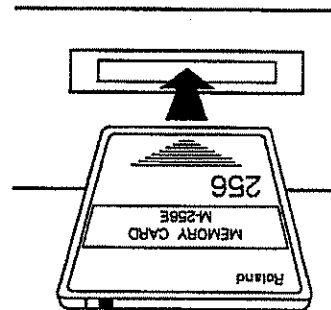

*Never insert a RAM Card into the PCM Card slot. Leaving it inserted for a long period of time will cause malfunctions.

*If you insert or remove a RAM Card while playing, the sound may stop for a short time, but this is not a malfunction.

■ The RAM Card protect switch

RAM Cards have a protect switch to prevent RAM Card data from accidentally being erased. Normally you should leave this on. When storing data, turn it on or off (leaving the RAM Card inserted in the slot).



5. Using MIDI to Select Performances or Patches

MIDI Program Change messages can select Performances or Patches.

■ To select Performances

Program Change messages received on the System Setup Control Channel will select the corresponding Performance (☞ P.137).

*If the Control Channel is Off, Performances will not be selected. Page 157, 162 explains how to set the Control Channel.

*Control Channel can be used only in the Play Mode.

		Number							
		1	2	3	4	5	6	7	8
Internal (I)	Bank								
	1	1	2	3	4	5	6	7	8
	2	9	10	11	12	13	14	15	16
	3	17	18	19	20	21	22	23	24
	4	25	26	27	28	29	30	31	32
	5	33	34	35	36	37	38	39	40
	6	41	42	43	44	45	46	47	48
	7	49	50	51	52	53	54	55	56
8	57	58	59	60	61	62	63	64	
RAM card (C)	1	65	66	67	68	69	70	71	72
	2	73	74	75	76	77	78	79	80
	3	81	82	83	84	85	86	87	88
	4	89	90	91	92	93	94	95	96
	5	97	98	99	100	101	102	103	104
	6	105	106	107	108	109	110	111	112
	7	113	114	115	116	117	118	119	120
	8	121	122	123	124	125	126	127	128

*When a RAM card is not connected to the D-70, incoming Program Change messages 65 — 128 will not select Performances.

■ To select Patches

Program Change messages received on the channel of each Part will select the corresponding Patch.

*Even if the Rhythm Part receives a Program Change message, the Rhythm Setup will not change.

*If the Part channel is Off, Patches will not be selected. Page 157, 162 explains how to set Part channels.

*Turn On the P.Change Rx of the Part. (⇐ P.67, 99)

Incoming Program Change messages will select Patches as follows.

Group	Bank	Number							
		1	2	3	4	5	6	7	8
A	1	1	2	3	4	5	6	7	8
	2	9	10	11	12	13	14	15	16
	3	17	18	19	20	21	22	23	24
	4	25	26	27	28	29	30	31	32
	5	33	34	35	36	37	38	39	40
	6	41	42	43	44	45	46	47	48
	7	49	50	51	52	53	54	55	56
	8	57	58	59	60	61	62	63	64
B	1	65	66	67	68	69	70	71	72
	2	73	74	75	76	77	78	79	80
	3	81	82	83	84	85	86	87	88
	4	89	90	91	92	93	94	95	96
	5	97	98	99	100	101	102	103	104
	6	105	106	107	108	109	110	111	112
	7	113	114	115	116	117	118	119	120
	8	121	122	123	124	125	126	127	128

■ About Program Change Numbers

The Program Change Number corresponding to each Performance or Patch will be displayed in parentheses ().

(Example) Performance I:35(21)
 Patch I:A88(64)

The Program Change Number of the actual MIDI message covers a range of 0 — 127, but the numbers displayed here in parentheses cover the range of 1 — 128. Thus, a Program Change Number of 0 will select the Performance or Patch for which (1) is displayed.

6. The Panic Function

If notes or pitch bender or modulation controllers “stick” (fail to turn off or return to the normal setting) for D - 70 internal sounds or external MIDI sound sources, this Panic function will help you resume normal operation.

*When you use the Panic function, data will be re-read from the memory area of the same Performance number. If you have edited the data, all the data in the Temporary area will be lost. (P.81)

[Procedure]

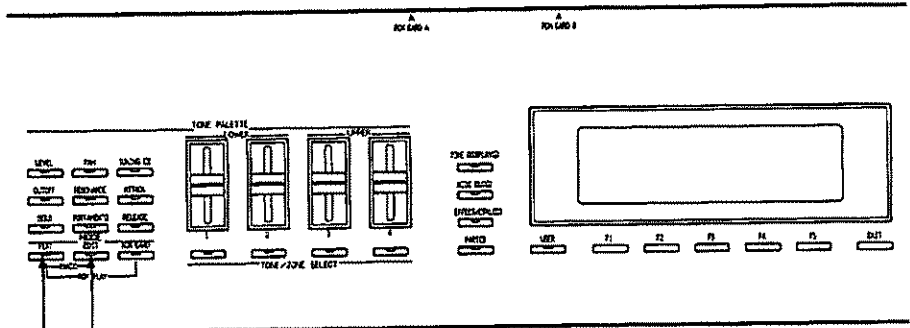

While pressing **PLAY** press **EDIT**.

The internal and external MIDI sound sources will be reset.

*While the Panic function is executing, there will be no sound for approximately four seconds.

■ Transmitted data

The following data will be transmitted on all MIDI Channels (1 - 16).

1. Note Off for all notes
(Note Off velocity 127, not Note On velocity 0.)
2. Pitch Bend center
3. Channel Aftertouch 0
4. Modulation 0
5. Hold1 0
6. Volume 127

③ FUNCTIONS OF EACH DISPLAY (PLAY MODE)

Since D-70 allows you to select and operate a wide variety of functions in realtime while playing, it is especially suitable for live performance.

This section will explain the functions available from the Play mode displays (the displays selected when you press **PLAY**, **TONE DISPLAY**, **EFFECT/CTRL**, **PART**, or **MIDI OUT**).

1. User Set

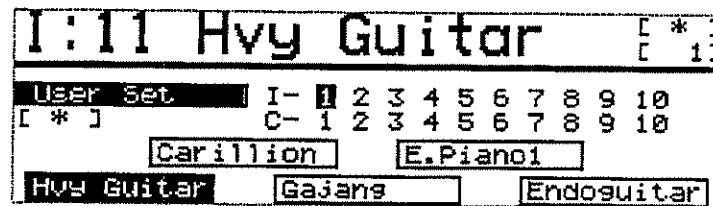

[To get this display] Press **PLAY**.

■ To select a User Set Group

You can select either internal (I) or RAM Card (C) Groups.

[Setting range] I-1 — 10, C-1 — 10

[Procedure] Select internal/RAM Card → **▲**/**▼**
 Select a Group → **◀**/**▶**

*To select a group in the internal memory, use **BANK** buttons (1 — 8), and to change groups on a RAM card, use **NUMBER** buttons (1 — 8). Group 9 or 10 cannot be selected.

*If a RAM Card is not inserted, RAM Card Groups cannot be selected.

■ To select a Performance

You can select Performances which have been assigned to the selected Group. The selected Performance will be displayed in inverse display.

[Procedure] Select a Performance → **F1** — **F5**

*When a RAM card is not connected to the D-70, Performances on the RAM card cannot be used.

2. Tone Display

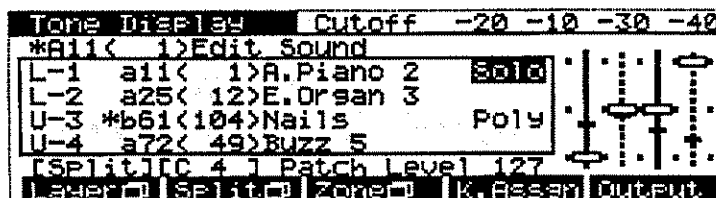

【To get this display】 Press **TONE DISPLAY**. (The display will change each time you press the button.)

* This display can be selected only when the KB PART is set to a Synthe Part (Part 1 — 5).
It cannot be selected if the KB PART is set to Rhythm Part or Off (☞ P.67).

■ **To set Key Assign** You can set Key Assign for Lower and Upper. (☞ P.28)

【Setting range】 Poly/Solo
【Procedure】 Display → **F4** **K.Assgn**
 Move the cursor → **▲**/**▼**/**◀**/**▶**
 Select Poly/Solo → **INC**/**DEC**, **VALUE**

* If either Lower or Upper is set to Solo, the **SOLO** indicator will light.

■ **To set Output Assign**

You can set Output Assign for each Tone. (☞ P.26)

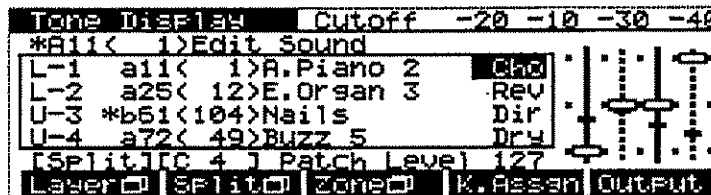

【Setting range】 Rev/Cho/Dry/Dir
【Procedure】 Display → **F5** **Output**
 Move the cursor → **▲**/**▼**/**◀**/**▶**
 Select the Output Assign → **INC**/**DEC**, **VALUE**

■ **To set Patch Level** You can adjust the volume of the entire Patch.

【Setting range】 0 — 127
【Procedure】 Move the cursor → **▲**/**▼**/**◀**/**▶**
 Set the value → **INC**/**DEC**, **VALUE**

■ To set Key Mode

You can change the Key Mode. (☞ P.27)

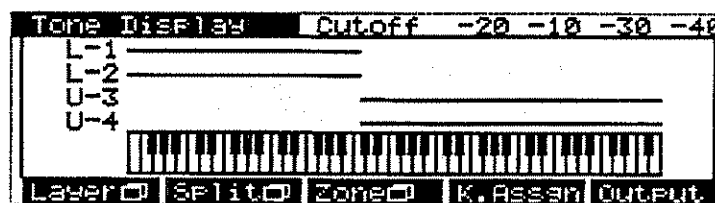

【Setting range】 Layer/Split/Zone

【Procedure】 Press any one of **[F1] Layer** , **[F2] Split** ,
or **[F3] Zone** .

★ For buttons **[F1]** — **[F3]** , you can press the button once again to get a graphic display of the settings for the selected mode. (To return to the previous display, press the button once again, or press **[EXIT]** .)

■ To set the Split Point

If Split mode has been selected, you can set the Split Point which divides the keyboard into Lower and Upper. (☞ P.27)

【Procedure】 While pressing **[F2]** , press the key to be the new Split Point. The new Split Point will be displayed.

* The key of the Split Point belongs to the Lower section.

■ To use the Tone Palette Sliders to edit

You can move the sliders to edit parameters which have been assigned to the Tone Palette. The Tone Palette Buttons select the parameters which will be controlled. (☞ P.39)

[LEVEL]

Level: 0 — 127

Adjust the volume of each Section. (☞ P.111)

[PAN]

Pan: 7> — << — <7

Set the Pan (stereo position) of each Section. (☞ P.113)

[TUNING]

K.Shift: -24 semi-tone — +24 semi-tone, F.Tune: -64 — +63

Adjust the tuning of each Section. Each time this button is pressed, it will alternate between K.Shift (Key Shift: half step units) and F.Tune (Fine Tune: fine adjustment). (☞ P.111)

[CUTOFF]

Cutoff: -64 — +63

Make relative adjustments to the Cutoff Frequency of the Tone of each Section. (☞ P.112)

[RESONANCE]

Reso: -64 — +63

Make relative adjustments to the Resonance of the Tone of each Section. (☞ P.112)

ATTACK (Attack Time) Attack: -64 — +63

Make relative adjustments to the Attack Time (TVF and TVA) of the Tone of each Section. (☞P.112)

RELEASE (Release Time) Release: -64 — +63

Make relative adjustments to the Release Time (TVF and TVA) of the Tone of each Section. (☞P.112)

[Procedure]

- ① Select the function you wish to edit.
- ② Use the Tone Palette Sliders to modify the value.

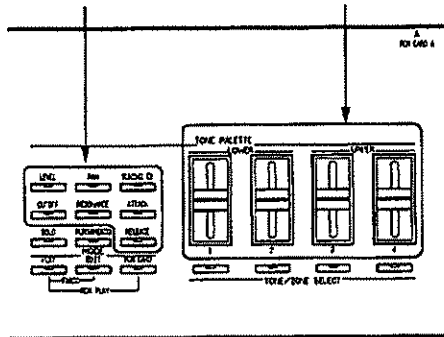

★ Note concerning slider operation

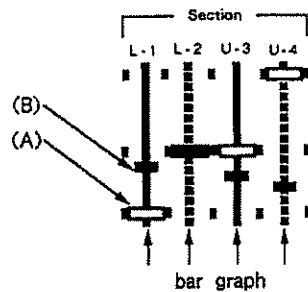

The screen will graphically indicate the Tone Palette Slider position (A) and the parameter value (B). To change the parameter value, you must first move (A) to the position of (B), and then move the Tone Palette Slider.

A dotted bar graph line indicates that the sound of that Section has been muted, and will not sound. (☞P.43, 113)

*The Tone Palette Sliders will function in the same way even in screens which have no graphic display.

3. L/U PRM

L/U PRM					
Velo Mode	Norm	Mix	Porta	Off	On
Threshold	100	100	P.Mode	Auto	Norm
Key Assign	Poly	Solo	P.Time	100	100
Solo Legato	Off	On			
[Split] [C 4]					
Layer	Split	Zoned	---	---	---

【To get this display】 Press **TONE DISPLAY** . (The display will change each time you press the button.)

* This display can be selected only when the KB PART is set to a Synthe Part (Part 1 — 5).

It cannot be selected if the KB PART is set to the Rhythm Part or Off (⇨ P.67).

* The value at left is for Lower, and the value at right is for Upper.

■ To specify how sounds will be produced

These settings determine how the KB PART will be sounded in the Lower and Upper sections.

* Portamento, Portamento Mode, and Portamento Time are effective only when Key Assign is set to Solo.

Velo Mode (Velocity Mode) Norm/SW/Mix

Specify how changes in key velocity will play the 1st Tone and 2nd Tone (⇨ P.27).

Threshold (Threshold Sensitivity) 0 — 127

When the Velocity Mode is set to SW or Mix, this parameter specifies the velocity value at which the 1st Tone and 2nd Tone will switch (⇨ P.27).

Key Assign

Poly/Solo

Select either Poly or Solo mode (⇨ P.28).

* If either Lower or Upper is set to Solo, the **SOLO** indicator will light.

Solo Legato

On/Off

Solo allows you two choices; Solo Legato and Solo (normal). When this is turned On, Solo Legato can be used (⇨ P.28).

Porta (Portamento)

On/Off

Turn Portamento On/Off (⇨ P.28).

* Portamento is effective only when Key Assign is Solo.

* If Portamento has been On for either Upper or Lower, the **PORTAMENTO** indicator will light.

P.Mode (Portamento Mode) Auto/Norm

Two modes of Portamento are provided; Auto and Normal. When Auto is selected, your playing technique will determine whether or not Portamento is applied (⇨ P.28).

P.Time (Portamento Time) 0—127

Specify the time over which Portamento will change the pitch (⇨ P.28).

【Procedure】 Move the cursor → **▲** / **▼** / **◀** / **▶**
 Modify the value → **INC** / **DEC** , **VALUE**

■ To set the Key Mode

You can select the Key Mode. (⇨ P.27)

【Setting range】 Layer/Split/Zone

【Procedure】 Press either **F1** Layer ⇨ , **F2** Split ⇨ , or **F3** Zone ⇨ .

■ To set the Split Point

If Split mode has been selected, you can set the Split Point which divides the keyboard into Upper and Lower. (⇨ P.27)

【Procedure】 While pressing **F2** , press the key you wish to set as the new Split Point. The new Split Point will be shown in the display.

* The key of the Split Point belongs to the Lower section.

4. Tone Display R

Tone Display R					Level	127
Key #	Media	Num	Name	Source	Key	
C 2	I- 3	1	SNAREDRUM1		C 2	
C#2	I- 3	19	CLAPS		C#2	
D 2	I- 3	2	SNAREDRUM2		D 2	
D#2	I- 3	10	TOM 1		D#2	
F 2	I- 3	12	HI-HAT		F 2	
Page ↑		Page ↓		Octave↑ Octave↓		

【To get this display】 Press **TONE DISPLAY**.

*This display can be selected only if the KB PART has been set to Rhythm Part. If the KB PART has been set to a Synthe Part (Part 1 — 5) or Off, this display cannot be selected (⇨P.67).

■ To check the settings of the Rhythm Setup

You can check the Rhythm tone settings for each key of the Rhythm Setup (⇨P.129).

【Procedure】

- Select the page → **F1** Page ↑ , **F2** Page ↓
- Select in units of an octave → **F3** Octave ↑ , **F4** Octave ↓
- Scroll → **INC** / **DEC** , **VALUE**

■ To set the level of the Rhythm Part

You can use the Tone Palette slider 1 to set the Output Level of the Rhythm Part. (⇨P.39)

【Setting range】 0 — 127

【Procedure】 use Tone Palette Slider 1

5. Reverb

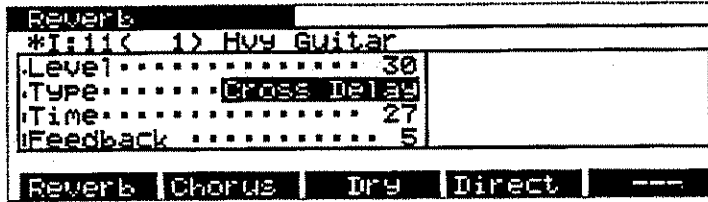

【To get this display】 Press **EFFECT/CTRL**. (The display will change each time you press the button.)

■ To make Reverb settings using the Tone Palette Sliders

The Tone Palette Sliders correspond to Reverb parameters as follows. You can adjust Reverb parameters by moving the sliders. In this display, the Tone Palette Buttons will not function.

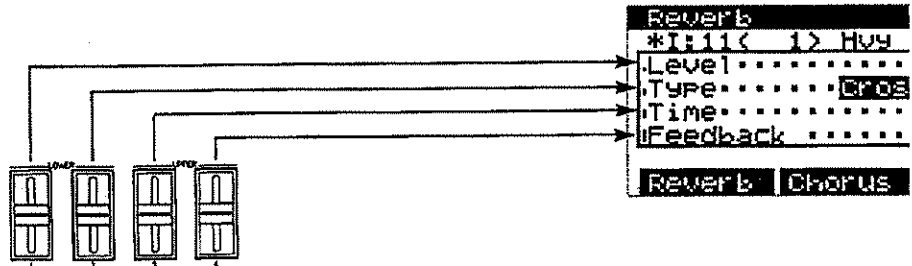

* The number of dots (1 — 4) to the left of the parameter name corresponds to the number of the Tone Palette Slider (1 — 4).

Level 0 — 31
Set the level of the reverb (delay) sound.

Type Room 1 — 3, Hall 1 — 2, Gate, Delay, Cross Delay
Set the Type of Reverb/Delay effect.

Room 1—3	Well-defined and spacious reverb
Hall 1, 2	Slower reverb, with greater depth than Room
Gate	Gated (sharply muted) reverb
Delay	Conventional delay
Cross Delay	Delayed repeats are panned to left and right







Time 0 — 31
Set the reverb time. If the Type is Delay or Cross Delay, this will set the delay time.

Feedback

0 — 31













Set the number of repeats for the delayed sound. This parameter is effective only for Types of Delay or Cross Delay.

★ Reverb settings can also be changed by moving the cursor.

【Procedure】 Move the cursor →  /  /  / 
 Modify the setting →  /  / 

■ To make Output Assign settings

You can specify how each Tone is output. (← P.26)

【Procedure】 set to Reverb → the  of each Section
 +  
 set to Chorus → the  of each Section
 +  
 set to Dry → the  of each Section
 +  
 set to Direct → the  of each Section
 +  

6. Chorus

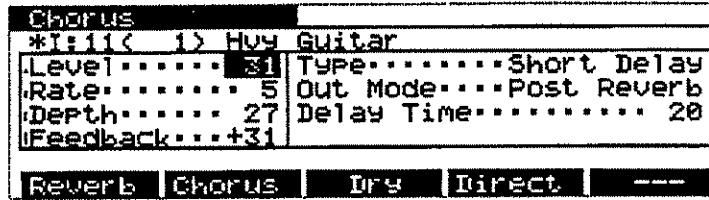

【To get this display】 Press **EFFECT/CTRL**. (The display will change each time you press the button.)

■ To make Chorus settings using the Tone Palette Sliders

The Tone Palette Sliders correspond to Chorus parameters as follows. You can adjust Chorus parameters by moving the sliders. In this display, the Tone Palette Buttons will not function.

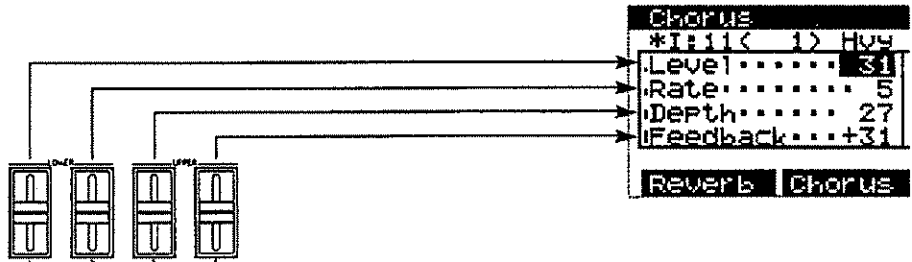

*The number of dots (1 — 4) to the left of the parameter name corresponds to the number of the Tone Palette Slider (1 — 4).

Level 0 — 31
Set the level of the effect processed sound.

Rate 0 — 31
Set the modulation frequency of the Chorus/Flanger effect.

*When the Type is set to Short Delay, this Rate parameter has no effect.

Depth 0 — 31
Set the depth of the Chorus or Flanger effect.

*When the Type is set to Short Delay, this Depth parameter has no effect.

Feedback

-31 — +31

Set the amount of feedback for the flanger or delay.

*When the Type is Flanger or FB-Chorus, this will change the character of the processed sound.

*When the Type is Short Delay, this will change the number of repeats.

*When the Type is Chorus 1 or 2, this Feedback parameter has no effect.

★ The above parameters can also be set using the cursor.

■ To make Chorus settings using the cursor

Parameters displayed at the right of the screen can be selected by the cursor.

Type

Chorus 1 — 2, FB-Chorus, Flanger, Short Delay

Specify the type of Chorus effect.

Chorus1	A spacious and rich effect
Chorus2	A deep ensemble effect, especially good for making strings richer
FB-Chorus	An effect mid-way between chorus and flanger
Flanger	A unique effect in which overtones change dramatically, especially effective for Tones containing many upper partials, such as HEAVY.EG
Short Delay	Short delayed repeats

Out Mode (Output Mode) Pre Reverb, Post Reverb

Specify how Chorus and Reverb will be connected.

Pre Reverb: Reverb will be added after the sound is processed through Chorus.

Post Reverb: Reverb will not be applied to the Chorused sound.

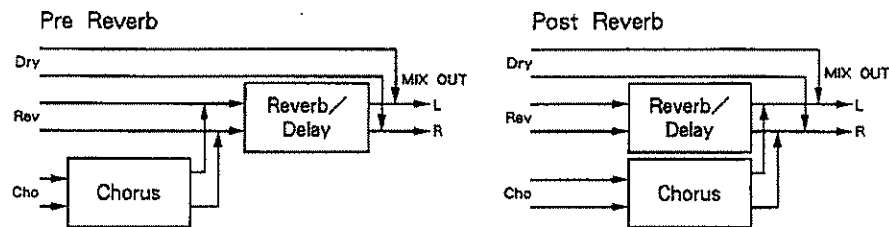

Delay Time







0 — 31

Specify the delay time used internally by the Chorus/Flanger.

*When the Type is Chorus 1, 2, or FB-Chorus, higher settings will result in a more spacious effect.













*When the Type is Flanger, lower settings will result in a stronger flanging effect, and higher settings will result in a more chorus-like setting.

*When the Type is Short Delay, this will determine the spacing of repeats.

【Procedure】 Move the cursor →  /  /  / 
 Modify the value →  /  , 

■ To make Output Assign settings

You can specify how each Tone is output. (☞ P.26)

【Procedure】 set to Reverb → the  of each Section
 +  
 set to Chorus → the  of each Section
 +  
 set to Dry → the  of each Section
 +  
 set to Direct → the  of each Section
 +  

7. Controller Map

Controller Map		
*I:11< 1> HV9 Guitar		
[Bender]		
Function	Value	Destination
<Pitch>	-36++12	Both
LFO Pitch	127	Lower
Bender	A.Touch	Mod
	C1/Exp	Pedal

【To get this display】 Press **EFFECT/CTRL00**. (The display will change each time you press the button.)

*This display can be selected only when the KB PART is set to a Synthe Part (Part 1 — 5).
It cannot be selected when the KB PART is set to Rhythm Part or Off. (P.67)

■ To set the Controller Map

These settings determine controller selections, and the function of each controller. This display simultaneously shows the Controller Maps of both the KB PRM and the KB PART (P.33).

● To select a Controller





【Procedure】 Bender Lever	→	F1 Bender
Aftertouch	→	F2 A.Touch
Modulation	→	F3 Mod
C1 Slider/Expression Pedal	→	F4 C1/Exp
Pedal	→	F5 Pedal



★ Each time you press **F5**, the selection will alternate between Pedal SW and Hold Pedal.

● To specify the functions of a Controller

Function	Value
Pitch Bend : change the pitch	Set in half-note steps. Positive settings (+) will raise the pitch. Negative settings (-) will lower the pitch. When the Controller is the Pitch Bender, the amount of change for left and right movement can be set independently.
TVF Cutoff : change the Cutoff Frequency	Set over a range of 0—127. 127 produces the maximum effect.
TVA Level : change the Volume	
LFO Pitch : change the Pitch Modulation (vibrato)	
LFT TVF : change the Cutoff Modulation (growl)	
LFO TVA : change the Volume Modulation (tremolo)	
Portamento Time : change the Portamento Time	no value setting
Octave Up : raise the pitch 1 octave	
Octave Down : lower the pitch 1 octave	
Hold : hold the sound	
Sostenuto : only the notes sounding when the pedal was pressed will be held, and notes played later will not be held	

- * The functions which can be selected will depend on the Controller.
- * It is not possible to make the same selection for both functions.
- * If the Bender Lever has been selected as the controller, function 1 will always be Pitch. The values can be set independently for Bend Up and Bend Down.
- * The C1 Slider and the Expression Pedal use the same Controller Map.
- * When the System Setup parameter Pedal SW has been set to Controller Map, the Pedal SW will function as determined by the Controller Map settings in this display (⇨ P.138).
- * The function (Hold or Sostenuato) of the Hold Pedal is determined by the System Setup parameter Hold Pedal (⇨ P.138).
- * If a function name is indicated by (), it cannot be selected.

【Procedure】 Move the cursor →  /  /  / 





 Modify the setting →  /  , 



* Depending on the sound data (Patch or Tone), controllers may have no effect. Check the parameters of the sound data (⇨ P.107, 114).

● To specify the keyboard range to which the effect will apply

Specify the Destination.

- Lower: The controller will apply to L - 1 and L - 2.
- Upper: The controller will apply to U - 3 and U - 4.
- Both: The controller will apply to L - 1 — U - 4.
- Off: The controller will have no effect.

【Procedure】 Move the cursor →  /  /  / 

 Modify the value →  /  , 

8. Part PRM 1/2

Part PRM 1		KB PART 1		
Prt	Ch	Patch	Zone	
1	10	*A11< 1>A.Piano	C#-1	G 9
2	11	*A12< 2>AcoustBass	C#-1	G 9
3	Off	A88< 64>Soundtrack	C#-1	G 9
4	Off	*B11< 65>Strings 1	C#-1	G 9
5	Off	*B11< 65>Strings 1	C#-1	G 9
KBPart↑		KBPart↓	On/Off	Synthe Rhythm

Part PRM 2		KB PART 1				
Prt	Level	Prior	Effect	A.Feel	PG#	Vol
1	127	On	Off	20	On	Off
2	127	Off	On	11	Off	On
3	127	Off	On	0	On	Off
4	127	On	Off	3	Off	On
5	127	On	Off	0	Off	On
KBPart↑		KBPart↓	On/Off	Synthe	Rhythm	

【To get this display】 Press **PART** . (The display will change each time you press the button.)

The settings of each Part (multi-timbre) in the Performance will be displayed.

★ To switch the display between the Synthe Parts (Parts 1 — 5) and the Rhythm Part, press

F4 **Synthe** or **F5** **Rhythm** .

■ Part settings

These parameters can be set for each Part.

CH (Receive Channel) 1 — 16/Off

Specify the channel on which MIDI messages will be received.

* If you turn Off Parts which you are not using, MIDI response will be faster.

* Page 157, 162 explains channel editing.

Patch (Patch Select) A11 — B88

Specify the Patch which the Part will play.

* This cannot be set for the Rhythm Part.

Zone C-1 — G9

Specify the Zone of the Part.

* In addition to this Part Zone, a Patch Key Mode can also be set. For details on how Key Mode is related to Zone or to MIDI OUT Key Mode, refer to P.31, "Key Mode and Zone".

Level (Output Level) 0 — 127

Specify the Output Level of the Part.

Prior (Priority)

On/Off

When the maximum 30 voices are exceeded, this determines whether or not to turn off the sound currently playing in the part. "On" will retain the sound, while "Off" will turn off the sound. Even when the Priority is set to On, the sound which takes on Release or Hold will be turned off.

Effect

On/Off

Specify whether or not the Part will use the effects unit. If this is set On, the Part will be processed through the effects unit as specified by the Output Assign settings of the Tone Palette (⇨ P.53).

The Rhythm Part will use the effects unit as specified by the Rhythm Tone Output Assign settings for each key (⇨ P.131).

*If the System Setup parameter Pedal SW has been set to Effector, the effector will be applied only while the pedal is pressed, and only to those Parts whose Effect parameter is turned On (⇨ P.138).

A.Feel (Analog Feel)

0 — 127

This parameter simulates the feeling of an analog synthesizer (slight deviations in pitch, etc.) for the Patch being played by the Part. A setting of 127 results in the maximum effect.

* This cannot be set for the Rhythm Part.

PG # (Program Change message receive switch)

On/Off

Specify whether the Part will receive Program Change messages (On) or ignore them (Off).

* The Rhythm Part does not receive Program Change messages.

Vol (Volume message receive switch)

On/Off

Specify whether the Part will receive Volume messages (On) or ignore them (Off).

[Procedure] Move the cursor → **▲** / **▼** / **◀** / **▶**
 Modify the value → **INC** / **DEC** , **VALUE**

■ **To select the KB PART**

You can select the KB PART. The selected KB PART will be shown in the upper line of the display.

[Procedure] Select the KB PART → **F1** **KBpart ↑** , **F2** **KBpart ↓**

*To turn the KB PART Off, press **F3** **On/Off** . When Off, the keyboard will not play any of the parts, but will only transmit note messages from MIDI OUT. Press the button once again, and KB PART will be set to 1.

9. MIDI OUT

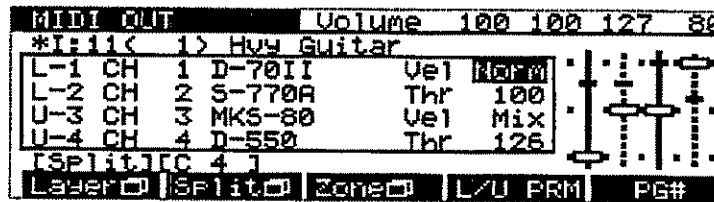

[To get this display] Press **MIDI OUT**. (The display will change each time you press the button.)

■ To set MIDI Channels

You can set the MIDI Channel for each Section of the MIDI Palette. For details of channel settings, refer to P.157, 162.

[Setting range] 1 — 16

[Procedure] Move the cursor → **▲/▼/◀/▶**
Set the channel → **INC/DEC, VALUE**

■ To set Velocity Mode/Threshold Sensitivity

You can set the Velocity Mode and Threshold Sensitivity of the Lower and Upper sections. (☞ P.30)

[Setting range] Vel (Velocity Mode): Norm/SW/Mix

Thr (Threshold Sensitivity): 0 — 127

[Procedure] Display → **F4 L/U PRM**
Move the cursor → **▲/▼/◀/▶**
Modify the value → **INC/DEC, VALUE**

■ To check Program Change Numbers

You can check the Program Change number of each Section.

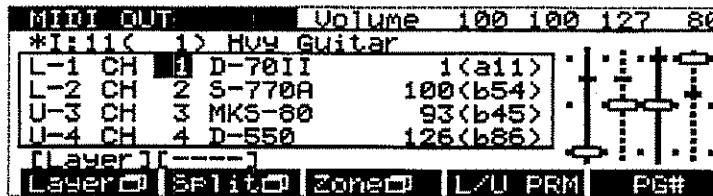

[Procedure] Display → **F5 PG#**

* For details on Program Change Number transmission, see P.46.

■ To set the Key Mode

You can set the MIDI OUT Key Mode of the Performance. (☞ P.30)

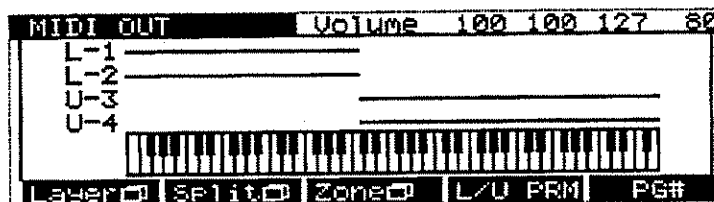

[Setting range] Layer/Split/Zone

[Procedure] Press either **[F1] Layer**, **[F2] Split**, or **[F3] Zone**.

★ If you press a button **[F1]** — **[F3]** once again, a graphic display will show the settings of the selected mode. (To return to the previous display, press that button once again, or press **[EXIT]**.)

■ To set the Split Point

If Split Mode has been selected, you can set the Split Point which divides the Keyboard into Upper and Lower sections. (☞ P.30)

[Procedure] While pressing **[F2]**, press the key you wish to set as the new Split Point. The new Split Point will be shown in the display.

* The key of the Split Point belongs to the Lower section.

■ To edit using the Tone Palette Sliders

You can use the sliders to edit some of the parameters in the MIDI Palette. Use the Tone Palette Buttons to select the parameter to control. (☞ P.39)

[LEVEL] (MIDI Volume) 0 — 127

Adjust the MIDI Volume of each Section. (☞ P.104)

[TUNING] (Transpose) -24 semi-tone — +24 semi-tone

Adjust the transposition of each Section. (☞ P.104)

10. MIDI CTRL Map

MIDI CTRL MAP			
*I:11< 1> HV9 Guitar			
[Bender 1			
Function	Value	Destination	
<Bender>	-----	Upper	
C.Chg 2/Breath	-----	Both	
Bender [A.Touch]	Mod	C1/Exp	Pedal <input type="checkbox"/>

【To get this display】 Press **[MIDI OUT]**. (The display will change each time you press the button.)

■ To set the Controller Map

These settings determine controller selections (Bender Lever, Pedal, etc.), and the function of each controller. (→ P.33)

● To select a Controller

【Procedure】 Bender Lever	→	[F1] Bender
Aftertouch	→	[F2] A.Touch
Modulation	→	[F3] Mod
C1 Slider/Expression Pedal	→	[F4] C1/Exp
Pedal	→	[F5] Pedal <input type="checkbox"/>

★ Each time you press **[F5]**, the selection will alternate between Pedal SW and Hold Pedal.

● To specify the functions of a Controller

Function	
Bender :	transmit Pitch Bender messages
C.Chg 0—C.Chg 95 :	transmit Control Change messages
After Touch :	transmit Aftertouch messages
Bender Up :	transmit Pitch Bender messages to raise the pitch
Bender Down :	transmit Pitch Bender messages to lower the pitch
C.Chg 64/Hold-1 :	transmit Hold messages







* The functions which can be selected will depend on the Controller.

* It is not possible to make the same selection for both functions.

* If the Bender Lever has been selected as the controller, function 1 will always be Bender.

* The C1 Slider and the Expression Pedal use the same Controller Map.

* When the System Setup parameter Pedal SW has been set to Controller Map, the Pedal SW will function as determined by the Controller Map settings in this display (→ P.138).

[Procedure] Move the cursor →  /  /  / 
 Modify the setting →  /  , 

*When the function name is indicated by (), it cannot be selected.

● To specify the keyboard range to which the effect will apply







Specify the Destination.

Lower: The controller will apply to L - 1 and L - 2.

Upper: The controller will apply to U - 3 and U - 4.

Both: The controller will apply to L - 1 — U - 4.

Off: The controller will have no effect.

[Procedure] Move the cursor →  /  /  / 
 Modify the value →  /  , 

Chapter 3

Edit

Chapter 3

1 OVERVIEW OF EDITING

The D - 70 has a large number of parameters in order to give you freedom in creating your own sounds. Before you begin editing, be sure that you understand how the parameters are organized.

1. Tones

The Tones of the D - 70 are organized as follows.

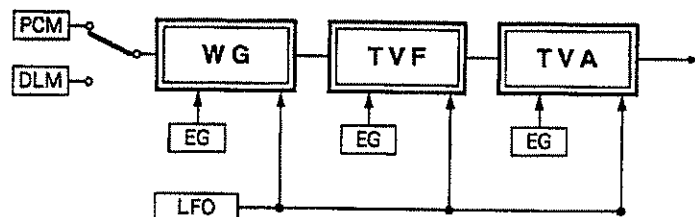

- PCM (Pulse Code Modulation)
The WG will use the PCM wave just as it is.
- DLM (Differential Loop Modulation)
The WG will use a section of the PCM wave and add Loop Modulation to that section to generate many inharmonic partials which were not present in the original PCM wave.
- *When the parameter "DLM" is turned On, DLM will be used. When turned Off, PCM will be used (→ P.115).
- WG (Wave Generator)
This controls the basic pitch of the Tone, and also selects the basic sound source waveform.
- TVF (Time Variant Filter)
This can be used in three modes (Low Pass, High Pass, or Band Pass) to control the timbre over the specified frequency range.
- TVA (Time Variant Amplifier)
This controls the volume.
- EG (Envelope Generator)
Create change over time for the WG, TVF, and TVF.
- LFO (Low Frequency Oscillator)
Modulate the WG, TVF, and TVA.

A Tone uses an "Original Tone"; i.e., a PCM wave. Internal memory contains three groups of Original Tone "Media" (banks), each containing many Original Tones. (Refer to page 186.)

In addition to the Original Tones in the D - 70's Internal memory, Original Tones may be taken from the SN-SPLA series for the D-series (sold separately), and from sound library Cards of the U-series (SN-U110 series, sold separately).

*Some PCM Cards cannot be used. For details, see P.93.

Maximum simultaneous notes

The D-70 can produce up to 30 voices at once (including voices in their release stage). If this 30-voice limit is exceeded, the Priority settings will determine which voices keep sounding (⇨ P.98).

Keyboard range

The highest note that can be sounded will differ depending on the Original Tone. If settings of the Tone parameter Pitch Coarse, or the Patch parameter Key Shift, etc. exceed this limit, there will be no sound. This is to be expected, since all acoustic instruments have natural limits to the pitch they can produce.

* The page 186 lists the keyboard ranges of the Original Tones.

How an Original Tone is organized

An Original Tone is organized as follows.

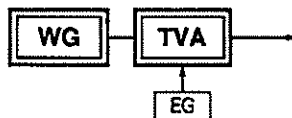

When you modify a Tone Edit parameter to select a different Original Tone, only the PCM Wave of the Original Tone will be read. If you also want to read the TVA parameters of the Original Tone, use the Tone command Orig.Tone PRM (⇨ P.158, 183).

Original Tones from a PCM Card

Some of the Original Tones in a SN-U110 series Card use a two-voice structure, such as Dual, Detune, or V-Mix (velocity mix).

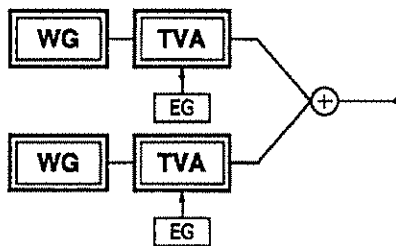

When a two-voice Original Tone is selected by the D-70, the voice for softly played notes (low velocity) will be used, and the voice for strongly played notes (high velocity) will not be used. When a SN-U110 series Original Tone is used by the D-70, this means that in some cases, the resulting sound will be the same even if different Original Tone numbers are selected.

2. PCM and DLM

One of the elements making up an Original Tone is the "WG" (Wave Generator). The WG can use either PCM (Pulse Code Modulation) or DLM (Differential Loop Modulation). This section will explain the differences between PCM and DLM.

■ If the WG is set to PCM

The PCM Wave data of the Original Tone is stored in the Original Tone area as follows. When a sound is played back in PCM, the data is read in order beginning from address 1, and the PCM wave is used just as it is.

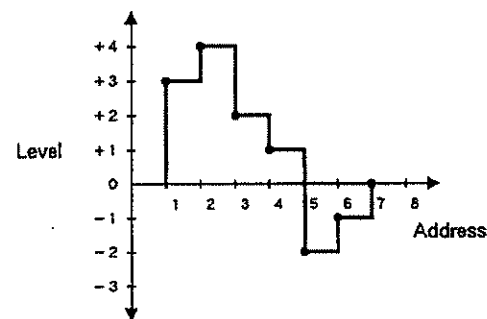

■ If the WG is set to DLM

DLM uses only the PCM Wave data that is specified by the Tone parameters Start and Length.

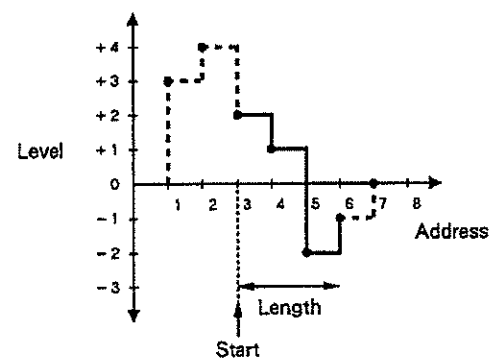

DLM does not simply loop the specified area of data, but calculates the difference between each point of the data, and creates a loop using data that corresponds to this difference. When the data reaches a certain level, it loops in the opposite direction.

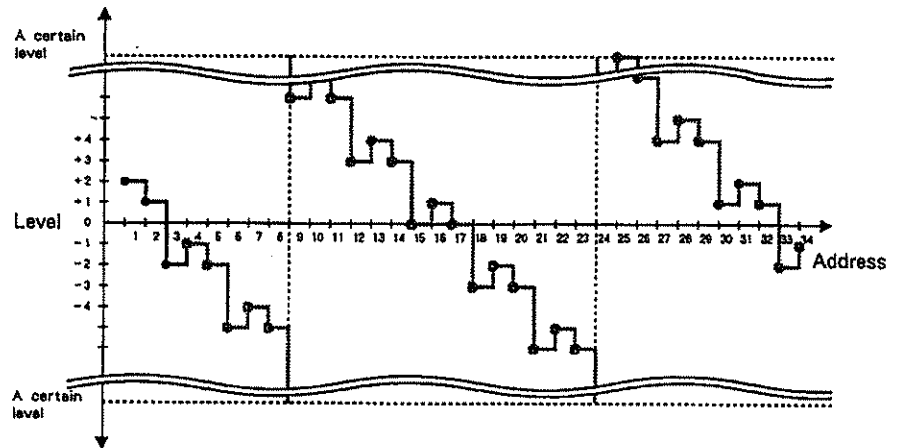

Waves read using DLM will contain a large number of inharmonic partials, allowing you to create sounds that were not possible with previous methods of generating sounds.

DLM has the following parameters (☞ P.115).

- | | |
|------------------|---|
| DLM (On, Off) | When this is turned On, DLM will be used. When Off, PCM will be used. |
| Mode (A/B) | Set this as you like. |
| Start (0 — 127) | Specify the Start Point from which to read the PCM Wave. |
| Length (1 — 128) | Specify the length (Loop Length) to be read from the PCM Wave. |

These parameters provide $2 \text{ (Mode)} \times 128 \text{ (Start)} \times 128 \text{ (Length)} = 32768$ different combinations. By modifying these parameters, you can make the sound change dynamically, and create very complex waveforms. In addition, you can use the TVF and TVA to create completely new sounds.

*Some Tones created using DLM may not sound over the entire keyboard range. For some DLM settings, there may be no sound.

*A Tone created by using the DLM may cause unstable pitch around the Upper Limit (the highest pitch to be played) of the Original Tone. For details about the Upper Limit, see page 186.

3. How Memory is organized

The parameters of the D - 70 are stored in locations called "Memories". Memories are organized into the following areas, according to their use or by parameter function.

- **System Setup area** The System Setup area contains parameters which affect the entire D - 70, such as Master Tune and MIDI data handling. Settings in the System Setup area are preserved even when the power is turned off.
- **Memory area** The Memory area contains 10 User Sets, 64 Performances, 128 Patches, and 128 Tones. Settings in the Memory area are preserved even when the power is turned off. You can select either RAM Card or Internal memory.
- **Temporary area** The Temporary area is where you modify the settings of the User Sets, Performances, Patches, or Tones. When you select a Performance, etc., the settings from the selected Memory area are called into the Temporary area. Settings in the Temporary area are temporary, and will be lost when you select another Performance etc., or when the power is turned off.
- **Rhythm Setup area** The Rhythm Setup area contains Rhythm Setup data that determines how drum sounds are combined, and how each drum will sound. Settings in the Rhythm Setup area are preserved even when the power is turned off.
- **Original Tone area** The Original Tone area contains the Original Tones which make up Tones. It is not possible to modify the settings of an Original Tone. You can select either PCM Card or Internal memory.

When you play the D - 70, the sound will be determined by the settings in the System Setup, Rhythm Setup, and the current Temporary area.

When you select a Performance, the settings of that Performance and the Patches used by that Performance are read into the Temporary area. At the same time, the Tones used by those Patches are also read into the Temporary area.

*When we say that data is read from the Memory area into the Temporary area, this is essentially the same as saying that the Memory area data is "copied" into the Temporary area.

The important thing to remember is that when you modify the settings of a Performance, or Patch, etc., you are modifying not the data in the Memory area but the data in the Temporary area. Settings in the Temporary area are temporary, and when you select a Performance or Patch, those settings will be lost. If you wish to keep the new settings you have made in the Temporary area, you must use the Write operation (⇨ P.150) and Store All function (⇨ P.158) to write the data into the Memory area. When editing parameters, always keep this in mind.

Data inside the D - 70 is transferred between areas as follows.

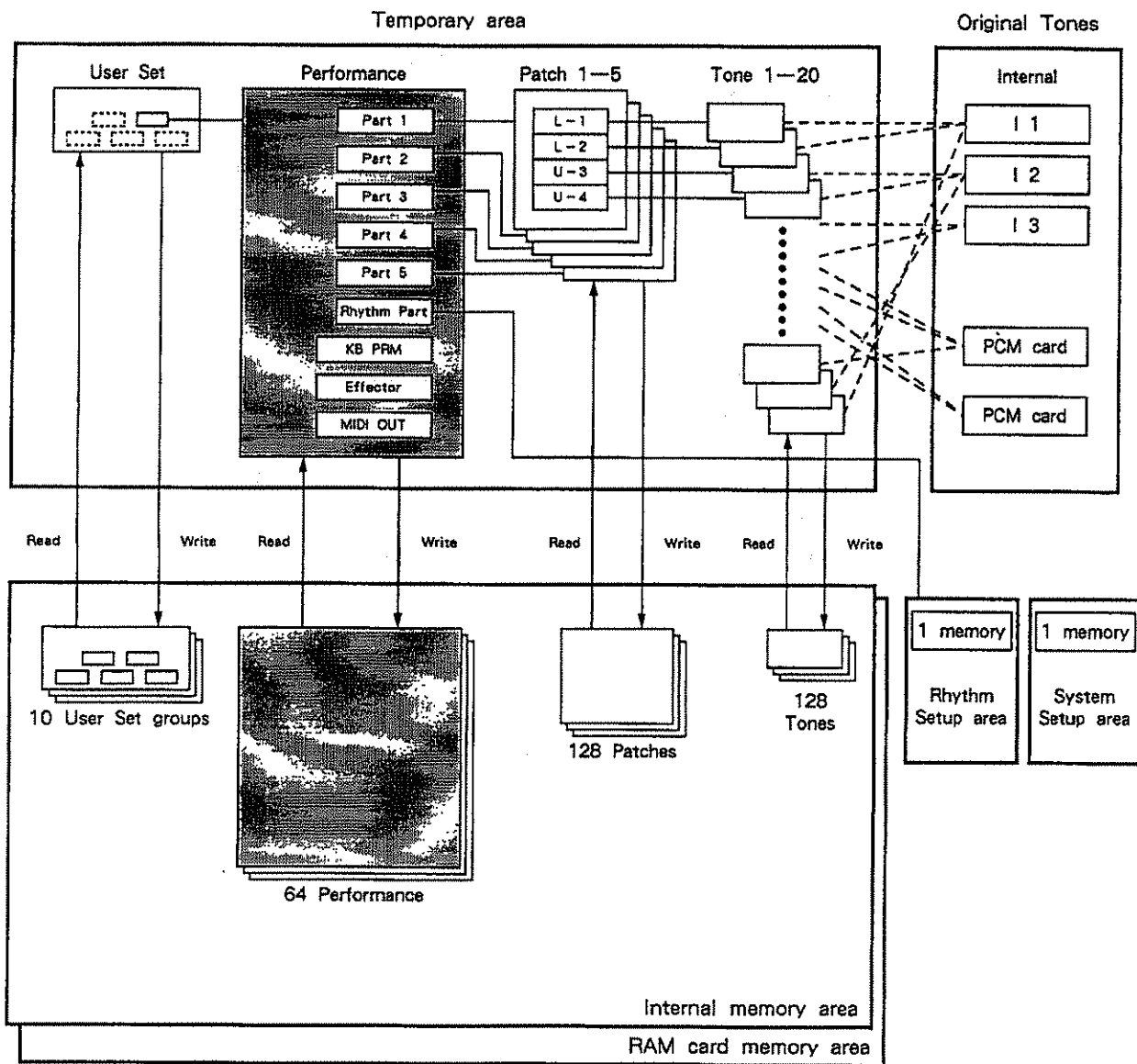

About data in the Temporary area

When you Edit or Write

When data is read from the Memory area into the Temporary area, all data of lower levels is automatically read into the Temporary area as well. (For example when a Performance is read into the Temporary area, the Patches and Tones used in that Performance will also be read into the Temporary area.) However, once data has been read into the Temporary area, all the Temporary area data will function independently. For this reason, please be aware of the following points when editing or writing data.

(Example 1) When editing a Patch

When the Synthe Parts 1 — 5 in a Performance are all set to Patch A11, suppose that you edited the Patch of Part 1, and used the Write operation to write it into A11.

At this time, only the Patch of Part 1 will use the edited data, and the Patches of Synthe Parts 2 — 5 will still have their previous (unedited A11) settings. If you re-select the Performance or Patch, or turn the power off (thus reading A11 into the Temporary area once again), the Patches of all Parts 1 — 5 will use the new A11.

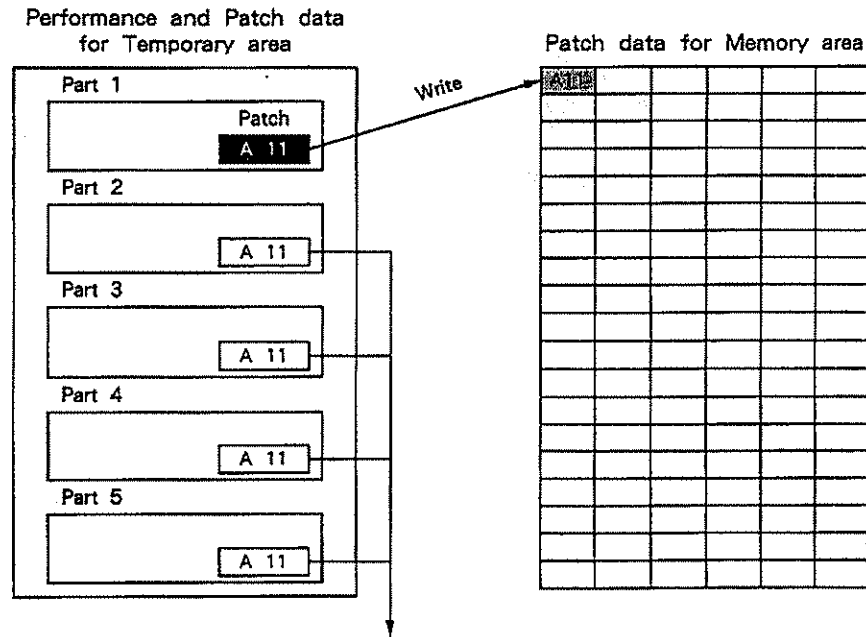

These maintain their previous settings, and the data in the Temporary area is not changed.

4. Rhythm Setup

The Rhythm Setup area contains Rhythm Setup data which determines how drum sounds are combined, and how each drum will sound. A Rhythm Setup allows you to assign a sound to each of the seventy-six keys E1(28) — G7(103) to create a Rhythm Tone.

A Rhythm Setup will be played by the Rhythm Part of the currently selected Performance.

(Example)

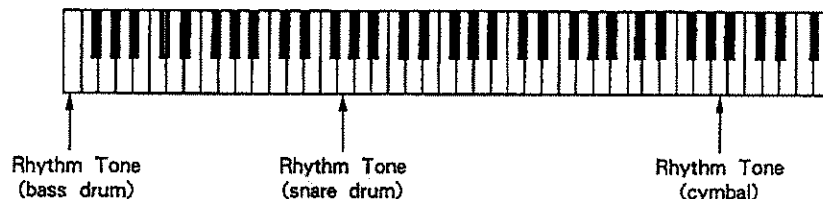

*Editing of a Rhythm Setup is not done in the Temporary area, so the Write operation is not needed.

The Rhythm Tone for each key is organized as follows.

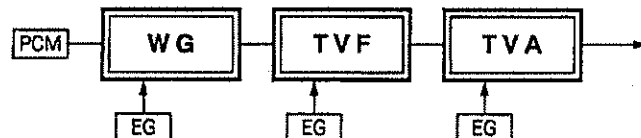

WG

(Wave Generator)

This controls the basic pitch of the Tone, and selects the waveform to be the basic sound source.

TVF

(Time Variant Filter)

This can be used in one of three modes (Low Pass, High Pass, or Band Pass), and controls the specified range of frequencies to adjust the timbre.

TVA

(Time Variant Amplifier)

This controls the volume.

EG

(Envelope Generator)

Create change over time for the WG, TVF, and TVA.

Each Rhythm Tone uses the PCM Wave of the specified Original Tone. Internal memory contains three "Media" (banks), each Media containing many Original Tones. (Refer to page 186) In addition to the Original Tones in the D-70's Internal memory, Original Tones may be taken from the SN-SPLA series for the D-series (sold separately), and from Sound Library Cards of the U-series (SN-U110 series, sold separately).

*Some PCM Cards cannot be used. For details, see P.93.

2 BASIC PROCEDURES (EDIT MODE)

The screen displays and buttons used in Edit mode follow some simple and consistent principles. Each display shows at a glance the available operations, so there is no need to remember complicated procedures. Follow the steps given below to learn the basic procedures for Edit mode.

1. How to View the Display

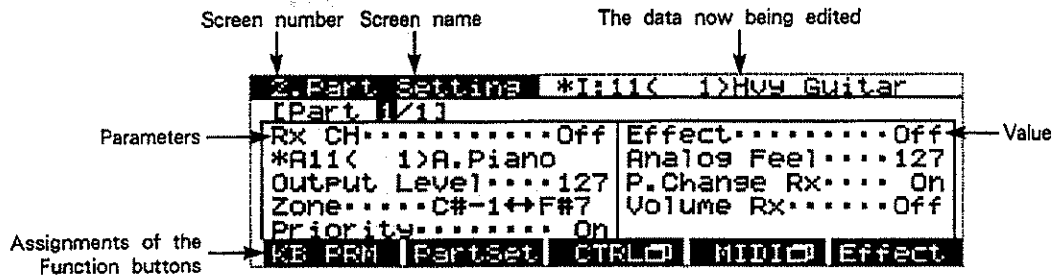

★ About the [*] mark in the display

If you have not yet written the edited data, this will be indicated by an " * " displayed before the number in the User Set, Performance, Patch, or Tone displays, or between the [] marks in a List display.

■ About the Function buttons

In Edit mode, the Function buttons are assigned the following functions.

● Select displays

The Function buttons can be used to select other displays. The display will change each time you press a button marked by .

● Execute a command (Transfer , Select , End , INIT , etc.)

The Function buttons can execute commands related to the screen.

* You will use "Commands" to make the D - 70 do some desired action such as transferring data or initializing data.

2. How to Select Displays

The displays in Edit mode are organized into the following tree-like structure.

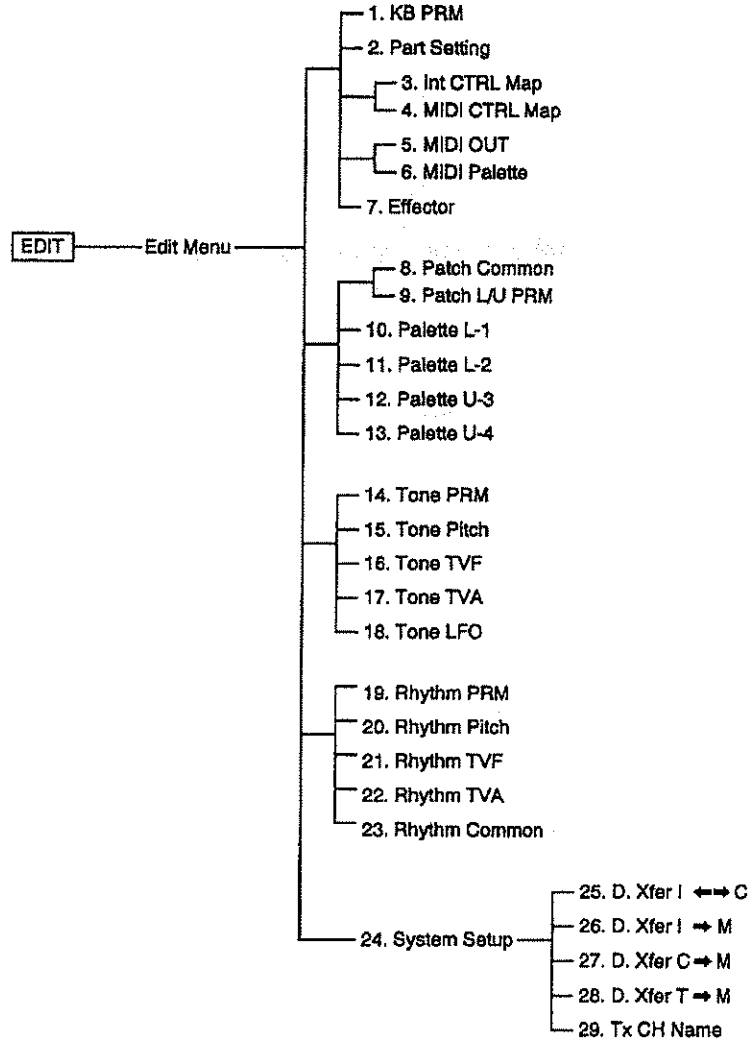

*Data Transfer functions are accessed via the 24. System Setup display.

■ Use the Menu to select a display

When you press the **EDIT** button, the Edit Menu display will appear. Press a Function button to get the desired editing display.

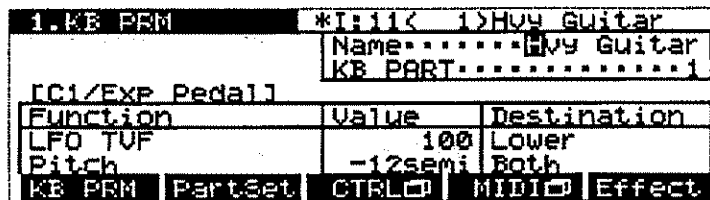
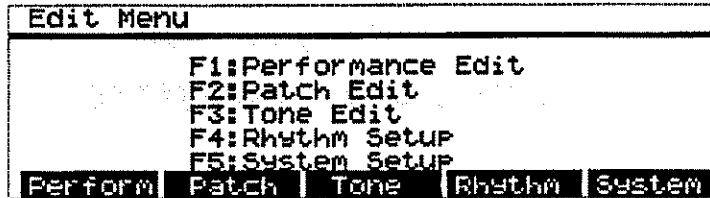

In Edit mode, you can use the Function buttons to select displays.

■ Use the Direct Jump function to select a display

In each Edit screen, a Screen Number is displayed at the left of the screen name. By assigning the screen numbers of frequently-used displays to the Function buttons, you can jump directly to any desired display.

*Displays in the Edit menu do not have a screen number.

● Direct Jump

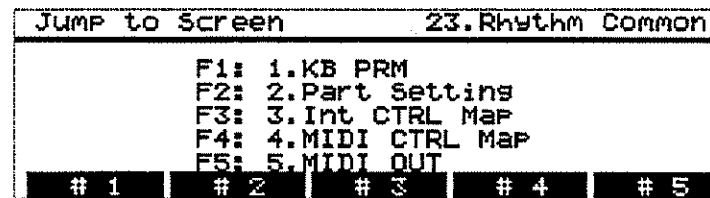

① Press **USER**.

② Press a button **F1** — **F5** to jump to the desired display.
To cancel without jumping, press **EXIT**.

*In the Orig.Tone (PCM) Play or ROM Play displays, pressing **USER** will not access the Jump display.

*It is not possible to Jump to a display which has no screen number.

● How to set a Jump Destination

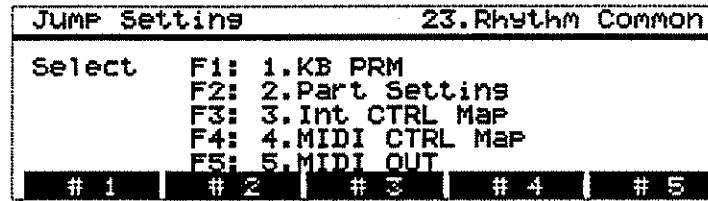

① Display the desired screen.

*It is not possible to assign a display which has no screen number.

② Press **USER**. (The Upper right of the display will show the number and name of the screen you are about to assign.)

③ Press **WRITE**. (The Jump Setting display will appear.)

④ Press the Function button (**F1** — **F5**) you wish to assign. To cancel without assigning, press **EXIT**.

After the assignment has been made, you will return to the display which was assigned.

■ To return to the previous higher level press **EXIT**

Edit mode is organized in a tree-like structure, and pressing **EXIT** will return you to the previous higher level.

■ To return to the Edit menu press **EDIT**

When you press **EDIT**, you will return to the Edit menu display.

3. How to Modify Settings

This section will explain how to modify parameter settings in the selected editing display.

■ Basic procedure to modify settings

Use / / / to move the cursor to the location of the parameter you wish to modify, and use / or to modify the value.

● How to enter characters

When entering a name for a Performance, Patch, Tone, or Tx Channel (MIDI Channel), you can select characters using the following buttons. (The characters are printed in grey below each button.)

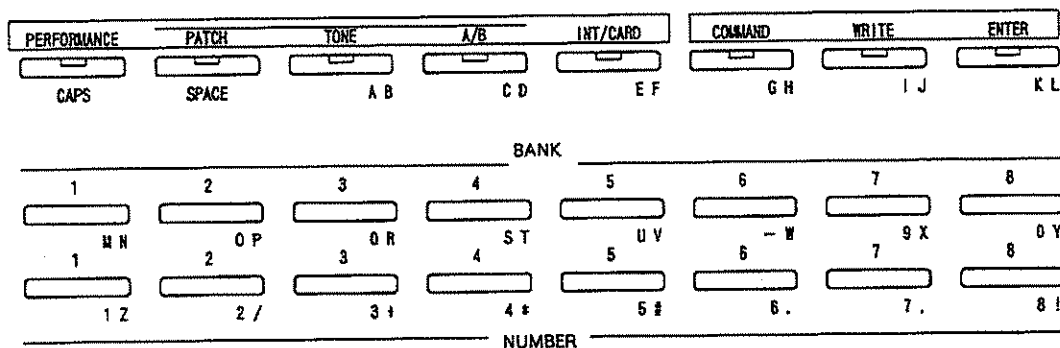

Use / / / to move the cursor to the location where you wish to input the character, and press a button to select a character. The characters will change each time you press the button.

- CAPS: Switch between upper case and lower case characters. Upper case characters are selected when the indicator is lit.
- SPACE: Enter a space.
- INS: Insert a space and push the following characters back.
- DEL: Delete a character and pull the following characters forward.

You can also select characters using .

(space) A - Z a - z 0 - 9 - / + * # . , !

■ Edit using the Tone Palette Sliders

While you are in an editing display, up to four parameters of each display can be assigned to sliders, allowing you to edit by moving the sliders.

Parameters can be edited even when the cursor is located at a different parameter. It is also possible to cancel the parameter assignments.

* In Edit mode, the Tone Palette Buttons will not function.

● To assign a slider

* Only parameters can be assigned. It is not possible to assign the following parameters.

- Zone, Split Point, Source Key, Mute
- Name
- Orig. Media, Orig. Number
- Controller Map

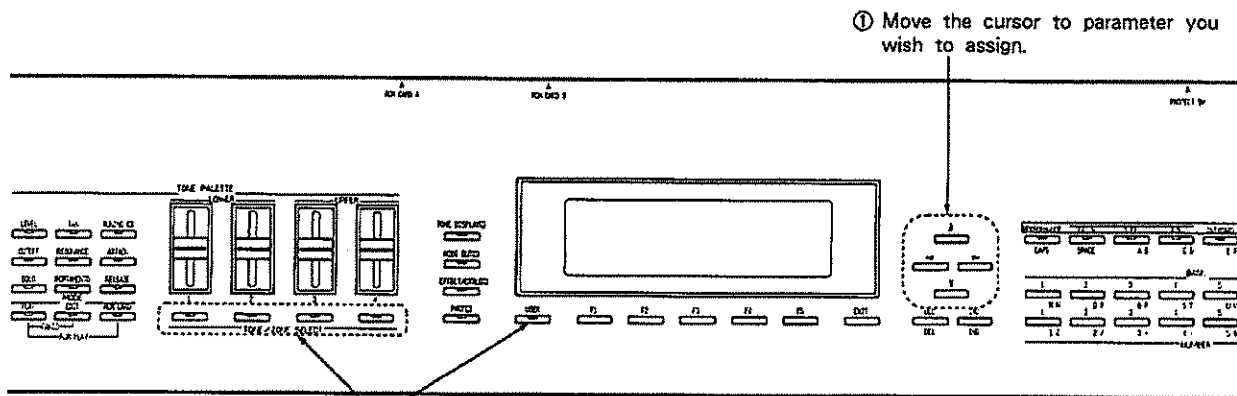

② While pressing the **TONE/ZONE SELECT** of the slider you wish to assign, press **USER**.

As shown below, dots will appear in the display at the left of the parameter or value. The number (1 — 4) of these dots indicates the number of the Tone Palette Slider (1 — 4). This indicates which parameter has been assigned to each Tone Palette Slider.

(Example)

```

Dot
  ↓
— ■ Cutoff
— ■ Reso
— ■ Attack
— ■ Release
    
```

● To cancel a slider assignment

While pressing the **TONE/ZONE SELECT** of the slider you wish to cancel, press **EXIT**.

■ Using **TONE/ZONE SELECT**

You can use **TONE/ZONE SELECT** to do the following.

- For each Section of the Tone Palette; mute the Tone

The **TONE/ZONE SELECT** buttons 1 — 4 correspond respectively to each Section (L-1 — U-4) of the Tone Palette.

* Do not press two or more **TONE/ZONE SELECT** buttons at the same time.

● To mute a Tone

In an editing display, you can mute the Tone of the Patch (each Section of the Tone Palette) of the Part selected in the display.

Press the **TONE/ZONE SELECT** that corresponds to the Tone you wish to mute. When a Tone is muted, the button indicator will go out.

【Performance Edit display】

Mute the Tone of the Patch of the Part selected in the 2.Part Setting display.

* Muting is not possible if the Rhythm Part is selected.

【Patch Edit display】

Mute the Tone of the Patch of the Part selected in the 8.Patch Common display.

【Tone Edit display】

Mute the Tone of the Patch of the Part selected in the 14.Tone PRM display.

【System Setup display】

Mute the Tone of the Patch of the Part selected in the 8.Patch Common display.

* You cannot mute a Tone in the Rhythm Setup display.

● To select a Tone

A Tone can be selected for each Section of the Patch of the Part selected in the editing display (⇐P.91).

● To change Sections

In the Tone Edit display, you can move to editing another Section.

While pressing the **TONE/ZONE SELECT** for the Section you wish to edit, press **EDIT**.

● To change Key Numbers

In the Rhythm Setup display, you can move to editing another Key Number.

While pressing a certain **TONE/ZONE SELECT**, press the key you wish to edit.

■ How to select Performances, Patches, and Tones

In Edit mode, the display shows the Performances, Patches, and Tones that were selected in Play mode and are now in the Temporary area.

You can also select these from inside Edit mode, but if you do so, remember that the Performance, Patch, and Tone data in the Temporary area will be lost (☞ P.78).

Performances, Patches, or Tones can be selected while viewing the respective List display.

● To select Performances

Press **PERFORMANCE** to get the Performance List display.

Use the **INT/CARD**, **BANK** and **NUMBER** to select, being sure to press **NUMBER** last. To return to the display from which you opened the List display, press **EXIT**.

* If you are already in Jump, Write or Command display, pressing **PERFORMANCE** will not take you to the List display. You must first press **EXIT** to return to the previous display, and then press **PERFORMANCE**.

* When you select a Performance on a RAM card, the indicator of **INT/CARD** will be lit.

● To select Patches

Press **PATCH** to get the Patch List display.

Use the **A/B**, **BANK**, and **NUMBER** to select, being sure to press **NUMBER** last. To return to the display from which you opened the List display, press **EXIT**.

[Performance Edit display]

Patch List of the Part selected in the 2.Part Setting display.

* The List display cannot be accessed if the Rhythm Part is selected.

[Patch Edit display]

Patch List of the Part selected in the 8.Patch Common display.

[Tone Edit display]

Patch List of the Part selected in the 14.Tone PRM display.

[System Setup display]

Patch List of the Part selected in the 8.Patch Common display.

* You cannot change Patches in the Rhythm Setup display.

* If you are already in Jump, Write or Command display, pressing **PATCH** will not take you to the List display. You must first press **EXIT** to return to the previous display, and then press **PATCH**.

● To select Tones

While pressing the desired **TONE / ZONE SELECT**, press **TONE** to get the Tone List display for the specified Section.

Use the **A/B**, **BANK**, and **NUMBER** to select, being sure to press **NUMBER** last. To return to the display from which you opened the List display, press **EXIT**.

【Performance Edit display】

Tone List of the Section pressed in the Patch of the Part selected in the 2.Part Setting display.

* The List display cannot be accessed if the Rhythm Part is selected.

【Patch Edit display】

Tone List of the Section pressed in the Patch of the Part selected in the 8.Patch Common display.

【Tone Edit display】

Tone List of the Section pressed in the Patch of the Part selected in the 14.Tone PRM display.

【System Setup display】

Tone List of the Section pressed in the Patch of the Part selected in the 8.Patch Common display.

* You cannot change Tones in the Rhythm Setup display.

* If you are in the Jump, Write or Command display, pressing **TONE** while holding **TONE / ZONE SELECT** will not enter the List display. You must first press **EXIT** to return to the previous display, and then press **TONE** while holding **TONE / ZONE SELECT**.

■ How to use **SOLO** and **PORTAMENTO**

Solo or Portamento settings for the Patch selected by the KB PART can be simultaneously switched for both Lower and Upper (☞ P.109).

SOLO

You can press **SOLO** to make Key Assign settings (Poly, Solo) for both Lower and Upper simultaneously. Each time you press the button, the setting will alternate between Poly and Solo. When Solo is selected, the **SOLO** indicator will light.

- * This will always determine the Key Assign setting of the KB PART, and will not affect the Patch of the Part selected in the Edit display.
- * If the KB PART is Rhythm or Off, it is not possible to switch between Solo and Poly.

PORTAMENTO

You can press **PORTAMENTO** to make Portamento settings (On, Off) for both Lower and Upper simultaneously. Each time you press the button, the setting will alternate between On and Off. When the Key Assign is Solo, and Portamento is On, the **PORTAMENTO** indicator will light.

- * This will always determine the Portamento setting of the KB PART, and will not affect the Patch of the Part selected in the Edit display.
- * If the KB PART is Rhythm or Off, it is not possible to switch Portamento On/Off.

5. Selecting an Original Tone

To select an Original Tone, specify the Original Tone Media (bank), and specify the Original Tone Number (☞ P.114, 129).

Internal memory contains three Original Tone media. In addition to those provided in Internal memory, you can also use Original Tones from SN - SPLA series Cards for the D - series and sound library Cards for the U - series (SN - U110 series).

(The Card number will be the Original Tone Media.)

The Original Tone Number you specify must not exceed the number of Original Tones contained in the Original Tone Media.

* If the specified Card is not inserted, there will be no sound.

* If you select a different Original Tone, only the PCM wave of the Original Tone will change. If you wish to read the Original Tone's parameters as well, use the Tone Command Orig.Tone PRM (☞ P.158, 163). However this Command cannot be used for the Rhythm Tone.

6. Points to Remember While Editing

When editing, please be aware of the following points.

■ Editing a Part

The keyboard will always play the KB PART settings. Since you can select Parts while in the edit display, the part being edited may not necessarily be the same as the part played by the keyboard. To check the sound of the Part you are editing, set the KB PART to that Part, or play the Part via MIDI (☞ P.66, 67, 96, 98).

The currently edited Part and the KB PART will be shown in the display as follows.

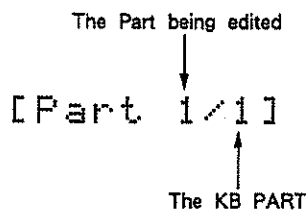

● You can select Parts in the Performance Edit, Patch Edit, and Tone Edit displays. However if you select a Part in a certain display, the other displays will switch to the selected Part. Also, if the Rhythm Part is selected in the Performance Edit display, this will switch to Part 1 when you move to either a Patch Edit or Tone Edit display.

● Controllers (Pitch Bender Lever, etc.) and **SOLO** and **PORTAMENTO** affect the KB PART, not the Part selected in the display. (If the KB PART is set to Rhythm or Off, controllers will have no effect.)

■ Editing a Tone

Patch parameters have an effect on how Tones will sound; i.e., the four Tones will sound as determined by the Patch parameters for Key Mode, Velocity Mode, Zone, Cutoff, etc. They will also be affected by the position of the Brightness slider and the condition of other controllers (Controller map settings, the position of the controllers, etc.).

You can edit only the Tone of the Section that is selected in the display. The other three Tones cannot be edited. To select the Section, either move the cursor, or hold the **TONE/ZONE SELECT** of the Section you wish to edit and then press **EDIT**. If you wish to mute the other Tones, press **TONE/ZONE SELECT** to turn Off the Tone of each Section.

■ Using Write or Command

If you wish to write the edited data into memory area, or execute an editing command, press **WRITE** or **COMMAND** to get a special display for that purpose.

For details refer to chapter 4 (☞ P.149).

3 FUNCTIONS OF EACH DISPLAY (EDIT MODE)

Performance Edit

1. KB PRM

1. KB PRM	*I:11< 1>Hvy Guitar	
	Name.....	Hvy Guitar
	KB PART.....	1
[C1/Exp Pedal]		
Function	Value	Destination
LFO TVF	100	Lower
Pitch	-12semi	Both
KB PRM	PartSet	CTRL [] MIDI [] Effect

Make settings for Keyboard parameters (Performance Name, KB PART, Keyboard Parameter Controllers).

Name (Performance Name) <Performance parameter>
Specify a ten-character name for the Performance. (☞ P.87)

KB PART (Keyboard Part) <Performance parameter>
This determines the Part that the keyboard will play. If this is set Off, the keyboard will not play any Part.
[Settings] [1] — [5], [R], [Off]

Controller Map

Controller Name Select Controllers for which you wish to set the Controller Map.
[C1/Exp Pedal], [Pedal SW]

- *When a MIDI Control Change message Data Entry (control change number 6) is received on the Control Channel (☞ P.137), it will have the effect specified by the Controller Map settings of C1/Exp Pedal.
- When a MIDI Control Change message of General Purpose Controller no.5 (control change number 80) is received on the Control Channel (☞ P.137), it will have the effect specified by the Controller Map settings of Pedal SW.
- *Depending on the sound data (Patch or Tone), controllers may have no effect. Check the parameters of the sound data (☞ P.107, 114).

Function <Performance parameter>
Select the function of the controller.

* It is not possible to select the same function twice.

◆ When the Controller is C1/Exp Pedal

[Settings]	[Pitch Bend]	Adjust the pitch.
	[TVF Cutoff]	Adjust the cutoff frequency.
	[TVA Level]	Adjust the volume.
	[LFO Pitch]	Adjust pitch modulation (vibrato).
	[LFO TVF]	Adjust cutoff frequency modulation (growl).
	[LFO TVA]	Adjust volume modulation (tremolo).
	[Portamento Time]	Adjust the Portamento time.

◆ When the Controller is Pedal SW

- 【Settings】 [LFO Pitch] Adjust pitch modulation (vibrato).
- [LFO TVF] Adjust cutoff frequency modulation (growl).
- [LFO TVA] Adjust volume modulation (tremolo).
- [Octave Up] Raise the pitch one octave.
- [Octave Down] Lower the pitch one octave.

Value

<Performance parameter>
Specify the range of the controller.

* If the controller is the Pedal SW, there is no need to set the Value.

◆ When the function is Pitch

Make settings in semi-tones (half steps). Positive (+) settings allow the controller to raise the pitch, and negative (-) settings allow the controller to lower the pitch.

- 【Settings】 [- 12 semi-tones] — [+12 semi-tones]

◆ When the function is other than Pitch

Specify how greatly the controller will control the effect. A setting of 127 allows maximum control.

- 【Settings】 [0] — [127]

* When the function is of Portamento Time, you do not need to set the value for it.

Destination

<Performance parameter>
Specify which Sections of the Tone Palette (Lower/Upper) will be affected by the controller.

- 【Settings】 [Lower] The controller will affect L-1 and L-2.
- [Upper] The controller will affect U-3 and U-4.
- [Both] The controller will affect all L-1 — U-4.
- [Off] The controller will affect neither Section.

2. Part Setting

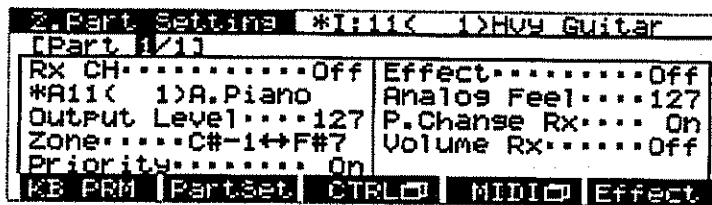

Specify how the Patch/Rhythm Setup of a Part/Rhythm Part will be played.

Part Number Select the Part you wish to edit. The KB PART is displayed as the denominator, and will be shown as “-” when turned Off.

[1] — [5], [R]

Rx CH (Receive Channel) <Performance parameter>

Specify the channel on which to receive MIDI messages.

[Settings] [1] — [16], [Off]

* If you turn Off unused Parts, MIDI response will be faster.

* It is more efficient to make channel settings in the CH Setting display (☞ P.157, 162).

Patch Select <Performance parameter>

Select the Patch to be played by the Part.

[Settings] [A11] — [A88], [B11] — [B88]

* For Internal Performances, select Internal Patches. For RAM Card Performances, select RAM Card Patches (☞ P.36).

* This can also be selected via MIDI Program Change messages (☞ P.50). Turn On the P.Change Rx of the Part.

* This cannot be set for the Rhythm Part.

Output Level <Performance parameter>

Specify the volume of the Part.

[Settings] [0] — [127]

* This can be changed via MIDI Volume messages. Turn On the Volume Rx of the Part.

Zone <Performance parameter>

Specify the Zone of the Part.

[Settings] [C-1] — [G9]

Priority <Performance parameter>

When the maximum 30 voices are exceeded, this determines whether or not to turn off the sound currently playing in the part. “On” will retain the sound, while “Off” will turn off the sound. Even when the Priority is set to On, the sound which takes on Release or Hold will be turned off.

[Settings] [On], [Off]

- Effect** <Performance parameter>
 Specify whether or not the Effector will be applied to the four Tones of the Part. When this is turned On, the effector will be applied as specified in Output Assign (P.112).
 For the Rhythm Part, this setting determines whether or not the effector will be applied to the Rhythm Tone of each key. When this is turned On, the effector will be applied as specified by the Output Assign settings for the Rhythm Tone of each key (P.131).
[Settings] [On], [Off]
 * If the System Setup parameter Pedal SW is set to Effector, the Effect will be applied to the Part only while the pedal is On (P.138).
- Analog Feel** <Performance parameter>
 Specify how greatly the feel (pitch variation, etc.) of an analog synthesizer will be simulated. A setting of 127 produces the maximum effect.
[Settings] [0] — [127]
 * This cannot be set for the Rhythm Part.
- P.Change Rx** (Program Change receive switch) <Performance parameter>
 Specify whether or not the Part will receive MIDI Program Change messages. When this is set On, they will be received.
[Settings] [On], [Off]
 * This cannot be set for the Rhythm Part.
- Volume Rx** (Volume receive switch) <Performance parameter>
 Specify whether or not the Part will receive MIDI Volume messages. When this is set On, they will be received.
[Settings] [On], [Off]

3. Int CTRL Map

3. Int CTRL MAP *T:11< 1>HUY Guitar		
[Part 1/1]		
[Bender 1]		
Function	Value	Destination
<Pitch>	-36↔+12	Both
TVF	100	Lower
KB PRM	PartSet	CTRL <input type="checkbox"/> MIDI <input type="checkbox"/> Effect

Specify Controller Map settings for a Synthe Part.

- Part Number** Select the Part you wish to edit. The KB PART is displayed as the denominator, and will be shown as “-” when turned Off.
 [1] — [5]
- Controller Name** Select the controller for which you wish to set the Controller Map.
 [Bender], [A.Touch], [Modulation], [Hold Pedal]
 * When MIDI messages of Bender, Channel Aftertouch, Modulation, or Hold are received on the MIDI Channel of a Synthe Part, the result will depend on the Controller Map settings.
 * Depending on the sound data (Patch or Tone), controllers may have no effect. Check the parameters of the sound data (P.107, 114).

Function

<Performance parameter>

Specify the functions for the controller

- * It is not possible to select the same function twice.
- * The Hold Pedal has one function.

◆ When the Controller is Bender

- | | | |
|------------|----------------|---|
| [Settings] | [[Pitch Bend]] | Adjust the pitch. The function is fixed at pitch. |
| | [TVF Cutoff] | Adjust the cutoff frequency. |
| | [TVA Level] | Adjust the volume. |
| | [LFO Pitch] | Adjust pitch modulation (vibrato). |
| | [LFO TVF] | Adjust cutoff frequency modulation (growl). |
| | [LFO TVA] | Adjust volume modulation (tremolo). |

◆ When the Controller is A.Touch or Modulation

- | | | |
|------------|--------------|---|
| [Settings] | [Pitch Bend] | Adjust the pitch. |
| | [TVF Cutoff] | Adjust the cutoff frequency. |
| | [TVA Level] | Adjust the volume. |
| | [LFO Pitch] | Adjust pitch modulation (vibrato). |
| | [LFO TVF] | Adjust cutoff frequency modulation (growl). |
| | [LFO TVA] | Adjust volume modulation (tremolo). |

◆ When the Controller is Hold Pedal

- | | | |
|------------|---------------|---|
| [Settings] | [[Hold]] | Sustain the sound. |
| | [[Sostenuto]] | The notes that were already pressed before the pedal was pressed will be sustained, but notes played later will not be sustained. |

* The System Setup parameter Hold Pedal determines whether Hold or Sostenuto is used (P.138).

Value

<Performance parameter>

Specify the range of the controller.

* If the controller is the Hold Pedal, there is no need to set the Value.

◆ When the function is Pitch

If the Controller is Bender, one of the functions will be fixed at Pitch. An arrow will be displayed at Value. The number at left indicates the pitch change when the Bender Lever is moved fully left. The number at right indicates the pitch change when the Bender Lever is moved fully right. These values are in semi-tone steps. Positive (+) settings allow the bender to raise the pitch, and negative settings (-) allow the bender to lower the pitch.

- | | | |
|------------|----------------------------------|--|
| [Settings] | [- 48 semi-tone] — [0 semi-tone] | value for when the bender is moved left |
| | [0 semi-tone] — [+12 semi-tone] | value for when the bender is moved right |

For other controllers, this can be specified in semi-tone steps. Positive (+) settings allow the controller to raise the pitch, and negative settings (-) allow the controller to lower the pitch.

- | | |
|------------|------------------------------------|
| [Settings] | [- 12 semi-tone] — [+12 semi-tone] |
|------------|------------------------------------|

◆ When the function is other than Pitch

Specify how greatly the controller will control the effect. A setting of 127 allows maximum control.

[Settings] [0] — [127]

Destination

<Performance parameter>

Specify which Sections of the Tone Palette (Lower/Upper) will be affected by the controller.

- [Settings] [Lower] The controller will affect L-1 and L-2.
 [Upper] The controller will affect U-3 and U-4.
 [Both] The controller will affect all L-1 — U-4.
 [Off] The controller will have no effect.

4. MIDI CTRL Map

4. MIDI CTRL MAP *I:11< 1>HYV Guitar		
[MIDI OUT]		
[Bender]		
Function	Value	Destination
<Bender>	-----	Lower
C.Chg 7/Volume	-----	Both
KB PRM	PartSet	CTRL
		MIDI
		Effect

Specify the Control Map for MIDI OUT.

Controller Name

Select the controller for which you wish to set the Controller Map.

[Bender], [A.Touch], [Modulation], [C1/Exp Pedal], [Pedal SW], [Hold Pedal]

Function

<Performance parameter>

Specify the functions for the controller.

*It is not possible to select the same function twice.

*The Hold Pedal has one function.

◆ When the Controller is Bender

- [Settings] [(Bender)] The controller will transmit Pitch Bend messages. The function is fixed at Pitch Bender.
 [C.Chg 0] — [C.Chg 95] The controller will transmit Control Change messages. The function name is shown at the right of the number. A display of " — — — " indicates that the control number has not yet been defined.
 [After Touch] The controller will transmit Channel Aftertouch messages.

◆ When the Controller is A.Touch, Modulation, or C1/Exp Pedal

- [Settings] [C.Chg 0] — [C.Chg 95] The controller will transmit Control Change messages. The function name is shown at the right of the number. A display of " — — — " indicates that the control number has not yet been defined.
 [Bender Up] The controller will transmit Pitch Bender messages to raise the pitch.
 [Bender Down] The controller will transmit Pitch Bender messages to lower the pitch.
 [After Touch] The controller will transmit Channel Aftertouch messages.

◆ When the Controller is Pedal SW

[Settings] [C.Chg 0] — [C.Chg 85] The controller will transmit Control Change messages. The function name is shown at the right of the number. A display of " --- " indicates that the control number has not yet been defined.

◆ When the Controller is Hold Pedal

[Settings] [(C.Chg 64/Hold-1)] The controller will transmit Hold messages. The function is fixed at Hold.

Value In the case of a MIDI OUT controller, there is no need to set the value.

Destination <Performance parameter>
Specify how the controller will be assigned to the Sections of the MIDI Palette (Lower/Upper).

- [Settings]** [Lower] The controller will affect L-1 and L-2.
 [Upper] The controller will affect U-3 and U-4.
 [Both] The controller will affect all L-1 — U-4.
 [Off] The controller will affect none of the Sections.

5. MIDI OUT

5. MIDI OUT		*1111 12345 Guitar	
Velo Curve.....1		L	U
Velo Sens..... 127	Velo Mode	Norm	SW
Key Mode... Split	Threshold	100	100
Split Point..C#2			

KB PRM | PartSet | CTRL | MIDI | Effect

Make setting for MIDI OUT.

Velo Curve (Velocity Curve) <Performance parameter>
Specify the way in which keyboard dynamics (velocity) will affect the volume. This setting applies to all four Sections of the MIDI Palette.

[Settings] [1] — [4]

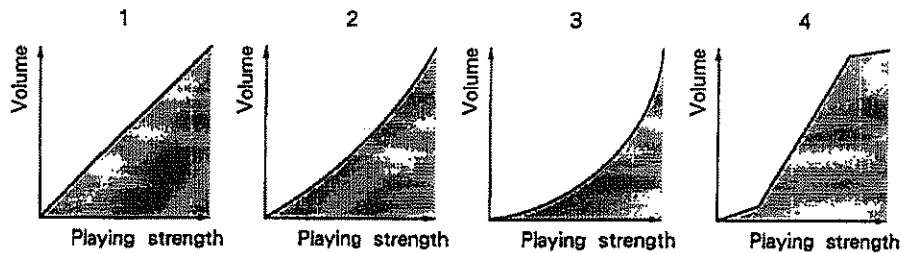

Velo Sens

(Velocity Sensitivity) <Performance parameter>

Specify how greatly keyboard dynamics (velocity) will affect the volume. This setting applies to all four Sections of the MIDI Palette. With a setting of 127, velocity will have the maximum effect on volume.

[Settings] [0] — [127]

(Example)

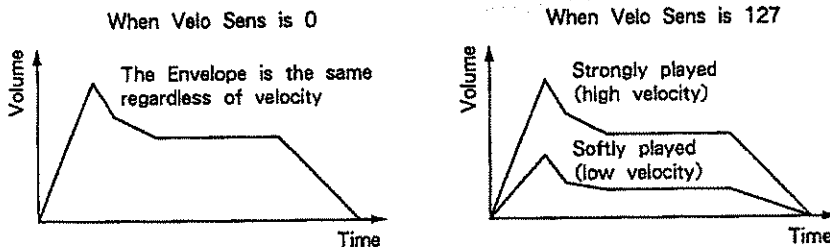

* The actual result of velocity will depend on the settings of the MIDI sound source.

Key Mode

<Performance parameter>

Specify how four external MIDI sound sources will be played (P.30).

[Settings] [Layer], [Split], [Zone]

Split Point

<Performance parameter>

Specify the Split Point used when the Key Mode is Split (P.30).

[Settings] [C-1] — [G9]



* The Split Point will be the highest note in the Lower area.

Velo Mode

(Velocity Mode) <Performance parameter>

Specify how keyboard dynamics (velocity) will affect the transmission of Note messages on the 1st channel and 2nd channel.

[Settings] [Normal], [SW], [Mix]

1st is indicated by 
 2nd is indicated by 

* These diagrams illustrate the Velocity Curve 1.

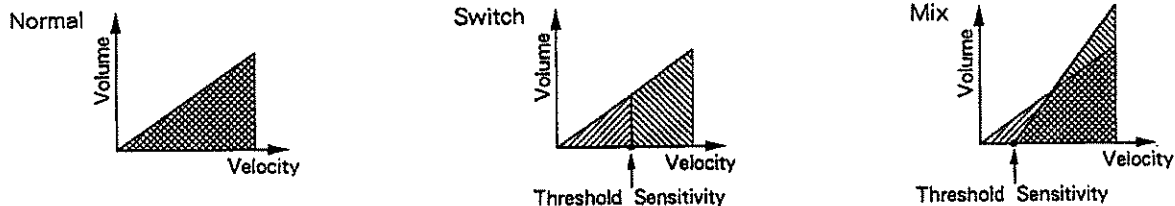

Threshold

(Threshold Sensitivity) <Performance parameter>

Specify the velocity at which Note message transmission will change from the 1st to the 2nd channel when the Velo Mode is SW or Mix.

[Settings] [0] — [127]

6. MIDI Palette

6. MIDI Palette		*I:11< 1>HVY Guitar	
Xpose CH	+24 11	U-1	+24 13 U-3
Vol Zone	127 C#-1↔G 9		127 C#-1↔G 9
PG# MIDI	1(a11) Off		93(b45) On
Xpose CH	+24 12	U-2	+24 14 U-4
Vol Zone	127 C#-1↔G 9		127 C#-1↔G 9
PG# MIDI	100(b54) Off		126(b86) Off
KE PRM	Part.set	CTRL	MIDI
			Effect

Make settings for each Section of the MIDI Palette.

Xpose

(Transpose) <Performance parameter>

The pitch played on the external MIDI sound source can be transposed relative to the key number of the D - 70 keyboard. The MIDI Note message that is transmitted will be shifted by the number of semi-tones specified by this setting.

[Settings] [- 24 semi-tone] — [+24 semi-tone]

Vol

(MIDI Volume) <Performance parameter>

Specify the MIDI Volume message that will be transmitted when you select the Performance.

[Settings] [0] — [127]

* If the System Setup parameter MIDI Link is turned Off, MIDI Volume messages will not be transmitted when you select Performances (☞ P.138).

* To transmit MIDI Volume in realtime, refer to P.39 and P.68.

PG

(Program Change Number) <Performance parameter>

Specify the Program Change Number that will be transmitted when you select the Performance.

[Settings] [1 (a11)] — [128 (b88)]

* If the System Setup parameter MIDI Link is turned Off, MIDI Program Change messages will not be transmitted when you select Performances (☞ P.138).

* To transmit MIDI Program Change messages in realtime, refer to P.46.

CH

(Transmission Channel) <Performance parameter>

Specify the transmission channel of each Section.

[Settings] [1] — [16]

* It is more efficient to modify the channel in the CH Setting display (☞ P.157, 162).

Zone

<Performance parameter>

Specify the Zone that will be used when Key Mode is set to Zone (☞ P.30).

[Settings] [C-1] — [G9]

MIDI

<Performance parameter>

Specify whether or not to transmit MIDI messages. If this is turned Off, no MIDI messages will be transmitted.

[Settings] [On], [Off]

7. Effector

7.Effector		*I:11<	1)Hvy Guitar
Reverb		Chorus	
Type.....	Type.....	Level....	12
Cross Delay	Short Delay	Delay....	30
Time.....	Out Mode....	Rate....	20
Level....	Post Reverb	Depth....	0
Feedback: 31		Feedback:-13	
KB PRM	PartSet	CTRL	MIDI
			Effect

Make settings for the effector (Reverb, Chorus).

■ Reverb

Type

(Reverb/Delay Type) <Performance parameter>

Select the type of Reverb/Delay.

[Settings] [Room 1] — [Room 3], [Hall 1], [Hall 2], [Gate], [Delay], [Cross Delay]

Room 1—3	Well-defined and spacious reverb
Hall 1, 2	Slower reverb, with greater depth than Room
Gate	Gated (sharply muted) reverb
Delay	Conventional delay
Cross Delay	Delayed repeats are panned to left and right

Time

(Reverb/Delay Time) <Performance parameter>

Specify the time length of the reverberation.

[Settings] [0] — [31]

* When the Type is Delay or Cross Delay, this setting determines the Delay Time.

Level

(Reverb/Delay Level) <Performance parameter>

Specify the volume of the reverberant (delayed) sound.

[Settings] [0] — [31]

Feedback

<Performance parameter>

Specify the number of delayed repeats.

[Settings] [0] — [31]

* This setting is valid only when the Type is Delay or Cross Delay.

■ Chorus

Type

(Chorus/Flanger Type) <Performance parameter>

Select the type of Chorus.

[Settings] [Chorus 1], [Chorus 2], [FB-Chorus], [Flanger], [Short Delay]

Chorus1	A spacious and rich effect
Chorus2	A deep ensemble effect, especially good for making strings richer
FB-Chorus	An effect mid-way between chorus and flanger
Flanger	A unique effect in which overtones change dramatically, especially effective for Tones containing many upper partials, such as HEAVY.EG
Short Delay	Short delayed repeats

Out Mode

(Output Mode) <Performance parameter>

Specify how Chorus and Reverb are connected.

- [Settings]** [Pre Reverb] Reverb will be added to the sound processed by Chorus.
- [Post Reverb] Reverb will not be added to the sound processed by Chorus.

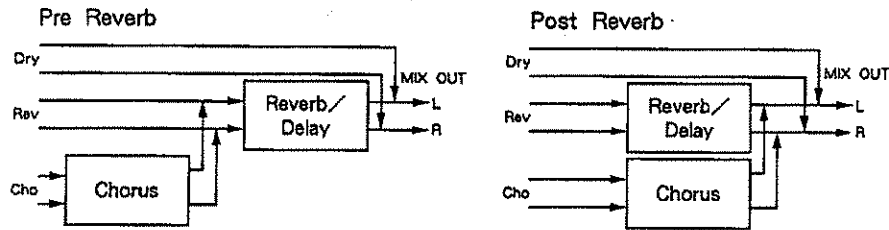

Level

(Chorus/Flanger Level) <Performance parameter>

Specify the volume of the effect.

- [Settings]** [0] — [31]

Delay

(Delay Time) <Performance parameter>

Specify the delay time used internally by the Chorus/Flanger.

- [Settings]** [0] — [31]

- *When the Type is Chorus 1, 2, or FB-Chorus, higher settings will result in a broader effect.
- *When the Type is Flanger, lower settings will result in a more flanger-like effect, and higher settings will result in a more Chorus-like effect.
- *When the Type is Short Delay, this determines the spacing of the repeats.

Rate

(Chorus/Flanger Rate) <Performance parameter>

Specify the modulation frequency of the Chorus/Flanger.

- [Settings]** [0] — [31]

- *When the Type is Short Delay, the Rate setting has no effect.

Depth

(Chorus/Flanger Depth) <Performance parameter>

Specify the depth of the Chorus/Flanger effect.

- [Settings]** [0] — [31]

- *When the Type is Short Delay, the Depth setting has no effect.

Feedback

<Performance parameter>

Specify the amount of feedback for the Flanger or Delay. Positive (+) or negative (-) settings will reverse the phase, resulting in a different effect.

- [Settings]** [-31] — [31]

- *When the Type is Flanger or FB-Chorus, this will affect the character of the processed sound.
- *When the Type is Short Delay, this will affect the number of repeats.
- *When the Type is Chorus 1 or 2, the Feedback setting has no effect.

Patch Edit

8. Patch Common

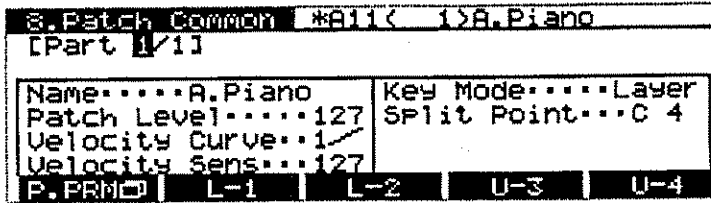

Make settings for Patch Common data (parameters that affect the entire Patch).

Part Number Select the Part you wish to edit. The KB PART is displayed as the denominator, and will be displayed as "-" if turned Off.
 [1]—[5]

Name (Patch Name) <Patch parameter>
 Specify a 10-character name for the Patch (P.87).

Patch Level <Patch parameter>
 Specify the level of the Patch. This setting will apply to all four Tones of the Tone Palette.
 [Settings] [0]—[127]

Velocity Curve <Patch parameter>
 Specify how volume will be affected by keyboard dynamics (velocity). This setting will apply to all four Tones of the Tone Palette.
 [Settings] [1]—[4]

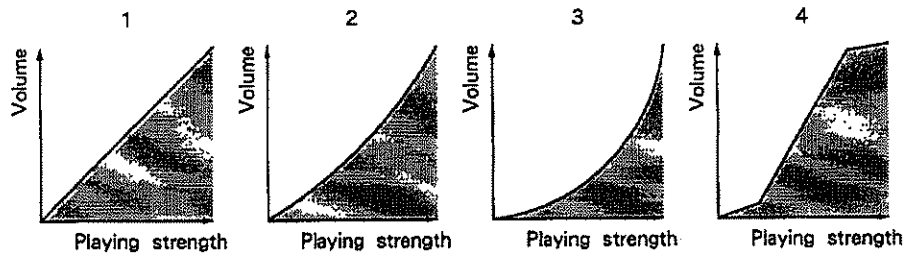

Velocity Sens (Velocity Sensitivity) <Patch parameter>
 Specify how greatly volume will be affected by keyboard dynamics (velocity). This setting will apply to all four Tones of the Tone Palette. With a setting of 127, velocity will have the maximum effect on volume.
 [Settings] [0]—[127]

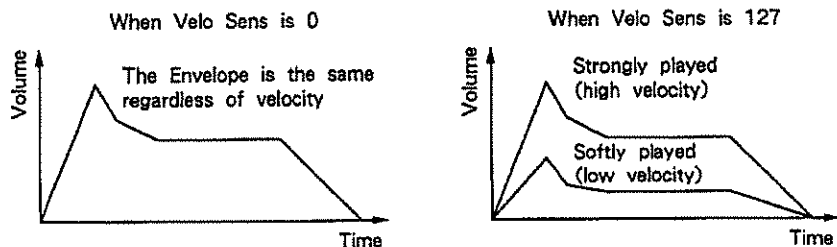

③ THE FUNCTIONS OF EACH DISPLAY (EDIT MODE)

Key Mode <Patch parameter>
Specify how the four Tones will be played (☞ P.27).
[Settings] [Layer], [Split], [Zone]

Split Point <Patch parameter>
Specify the Split Point which will be used when the Key Mode is Split (☞ P.27).
[Settings] [C-1] — [G9]

* The key of the Split Point belongs to the Lower Section.

9. Patch L/U PRM

9. Patch L/U PRM *ALL 1>A.Piano					
[Part. 1/1][Split]					
Velo Mode	Norm	Mix	Porta	Off	On
Threshold	100	100	P.Mode	Auto	Norm
Key Assign	Poly	Solo	P.Time	100	100
Solo Legato	Off	On	PortRx	Off	Off
			Pan Rx	On	Off
P.PRM	L-1	L-2	U-3	U-4	



Make settings for Lower and Upper sections of the Patch.

The value at left is for Lower, and the value at right is for Upper.

Part Number Select the Part you wish to edit. The KB PART is displayed as the denominator, and will be displayed as "-" if turned Off.
[1] — [5]

Key Mode <Patch parameter>
You can modify the Key Mode specified in the 8.Patch Common display.

Velo Mode (Velocity Mode) <Patch parameter>
Specify how keyboard dynamics (velocity) will play the 1st Tone and the 2nd Tone.
[Settings] [Normal], [SW], [Mix]

1st is indicated by 
2nd is indicated by 

* These diagrams illustrate the Velocity Curve 1 (☞ P.107).

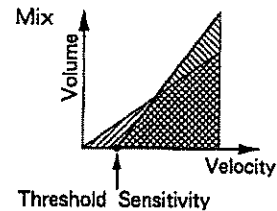
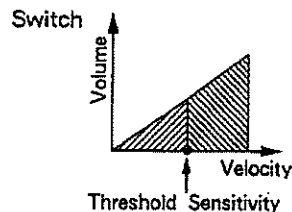
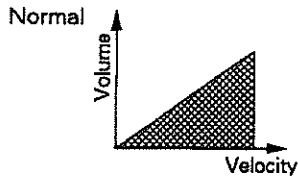

Threshold (Threshold Sensitivity) <Patch parameter>
Specify the velocity at which to switch from the 1st Tone to the 2nd Tone when the Velo Mode is SW or Mix.
[Settings] [0] — [127]

Key Assign

<Patch parameter>
Select Poly or Solo.

- 【Settings】** [Poly] play polyphonically
[Solo] play monophonically

* In Solo mode, when two or more keys are pressed simultaneously, the key pressed later will sound (last-note priority).

Solo Legato

<Patch parameter>
Select the Solo mode.

- 【Settings】** [On] Solo Legato (single triggering) will be used.
[Off] Solo (normal, multiple triggering) will be used.

Solo Legato: In this mode, if you play a note while the previous note is still pressed, the new note will continue the envelope of the previous note, allowing you to play smoothly without breaks in the sound.

- * The PCM Wave will be read from the beginning.
- * Depending on the TVF and TVA settings, the result may not sound legato.

Normal (Solo): In this mode, each note will re-trigger the envelope regardless of how you play, so that each note will have its own volume or tone envelope (pattern of change over time).

- * This setting has no effect unless Solo is selected.

Solo Legato

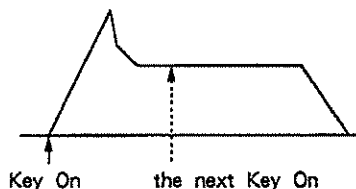

Normal (Solo)

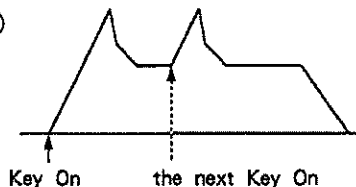

Porta

<Patch parameter>
When the Key Assign is Solo, you can use Portamento.

- 【Settings】** [On] The pitch will change smoothly from one note to the next.
[Off] There will be no Portamento effect.

- * Portamento is available only when the Key Assign is Solo.
- * MIDI messages can be used to switch Portamento on/off. Turn On the PortRx parameter for Lower or Upper.

③ THE FUNCTIONS OF EACH DISPLAY (EDIT MODE)

- P.Mode** (Portamento Mode) <Patch parameter>
Specify the Portamento Mode.
- 【Settings】** [Auto] Portamento will be applied whenever you press a key while holding the previous key. When you press a key after releasing the previous key, Portamento will not be applied. This allows you to selectively use Portamento according to your playing style.
[Norm] Portamento will be applied regardless of how you play.
- * If Portamento is not being used, the P.Mode setting has no effect.
- P.Time** (Portamento Time) <Patch parameter>
Specify the speed of pitch change caused by Portamento.
- 【Settings】** [0] — [127]
- * If Portamento is not being used, the P.Time setting has no effect.
* This can be changed via MIDI Portamento Time messages. Turn On the PortRx parameter for Lower or Upper.
- PortRx** (Portamento, Portamento Time receive switch) <Patch parameter>
Specify whether or not to receive MIDI Portamento and Portamento Time messages. If both Lower and Upper are turned On, they will be given the same Portamento settings.
- 【Settings】** [On] Receive
[Off] Ignore
- * Messages will be received on the channel of the Part which is playing the Patch.
- Pan Rx** (Pan receive switch) <Patch parameter>
Specify whether or not to receive MIDI Pan messages. If both Lower and Upper are turned On, they will be given the same pan settings.
- 【Settings】** [On] Receive
[Off] Ignore
- * Pan settings can be made independently for each Section of the Tone Palette, but if a MIDI Pan message is received, the 1st Tone and the 2nd Tone will be given the same pan settings.
* Messages will be received on the channel of the Part which is playing the Patch.

10. Palette L-1

10. Palette L-1 *a11< 1>8. Piano		
[Part 1/1][SPlit][INorm]		
*a11 R. Piano 1	Cutoff..-15	Out. Reverb
Level.....127	Reso.....+63	Pan.....><
K. Shift..-24semi	Attack...-10	Tone...Off
F. Tune.....+50	Release..-20	C#-1↑G 9
P. PRM	L-1	L-2 U-3 U-4

Make settings for each Section (L-1 — U-4) of the Tone Palette.

Make settings for 10. Palette L-1, 11. Palette L-2, 12. Palette U-3, and 13. Palette U-4 in each of their respective displays.

Part Number Select the Part you wish to edit. The KB PART is displayed as the denominator, and will be displayed as "-" if turned Off.
[1] — [5]

Key Mode <Patch parameter>
You can modify the Key Mode setting of the 8. Patch Common display (☞ P.108).

Velocity Mode <Patch parameter>
You can modify the Key Mode specified in the 9. Patch L/U PRM display (☞ P.108). The 10. Palette L-1 and 11. Palette L-2 displays will show the Velocity Mode for the Lower sections. The 12. Palette U-3 and 13. Palette U-4 displays will show the Velocity Mode for the Upper sections.

Tone Select <Patch parameter>
Select a Tone for each Section of the Tone Palette.
[Settings] [a11] — [a88], [b11] — [b88]

*Select Internal Patches and Tones for an Internal Performance, and select RAM Card Patches and Tones for a RAM Card Performance (☞ P.36).

Level <Patch parameter>
Specify the volume level of the Tone.
[Settings] [0] — [127]

K.Shift (Key Shift) <Patch parameter>
Specify a relative pitch adjustment for the Tone in steps of a semi-tone. When this parameter is set to 0, the pitch will be as specified by the Tone.
[Settings] [-24 semi-tone] — [+24 semi-tone]

*Tone parameters include Pitch Coarse (☞ P.116).

F.Tune (Fine Tune) <Patch parameter>
Specify a relative pitch adjustment for the Tone. A setting of 64 results in a change of a semi-tone. When this parameter is set to 0, the pitch will be as specified by the Tone.
[Settings] [-64] — [+63]

*Tone parameters include Pitch Fine (☞ P.116).

Cutoff

<Patch parameter>

Specify a relative adjustment to the TVF Cutoff Frequency of the Tone. When this parameter is set to 0, the cutoff frequency will be as specified by the Tone. Positive (+) settings result in a higher cutoff frequency.

【Settings】 [-64] — [+63]

* There is also a Tone parameter Cutoff, which specifies an absolute value (☞ P.119).

Reso

(Resonance) <Patch parameter>

Specify a relative adjustment to the TVF Resonance of the Tone. When this parameter is set to 0, the resonance will be as specified by the Tone. Positive (+) settings will result in increased emphasis of the frequency region around the Cutoff Frequency.

【Settings】 [-64] — [+63]

* There is also a Tone parameter Resonance, which specifies an absolute value (☞ P.120).

Attack

(Attack Time) <Patch parameter>

Specify a relative adjustment to the Attack Time of the TVF and TVA of the Tone. When this parameter is set to 0, the Attack Time will be as specified by the Tone. Positive (+) settings will result in a slower Attack Time.

【Settings】 [-64] — [+63]

* The Tone parameters for TVF and TVA Envelopes specify absolute values (☞ P.123, 126).

Release

(Release Time) <Patch parameter>

Specify a relative adjustment to the Release Time of the TVF and TVA of the Tone. When this parameter is set to 0, the Release Time will be as specified by the Tone. Positive (+) settings will result in a slower Release Time.

【Settings】 [-64] — [+63]

* The Tone parameters for TVF and TVA Envelopes specify absolute values (☞ P.123, 126).

Out

(Output Assign) <Patch parameter>

Specify how effects will be applied to the Tone.

【Settings】 [Reverb], [Chorus], [Dry], [Direct]

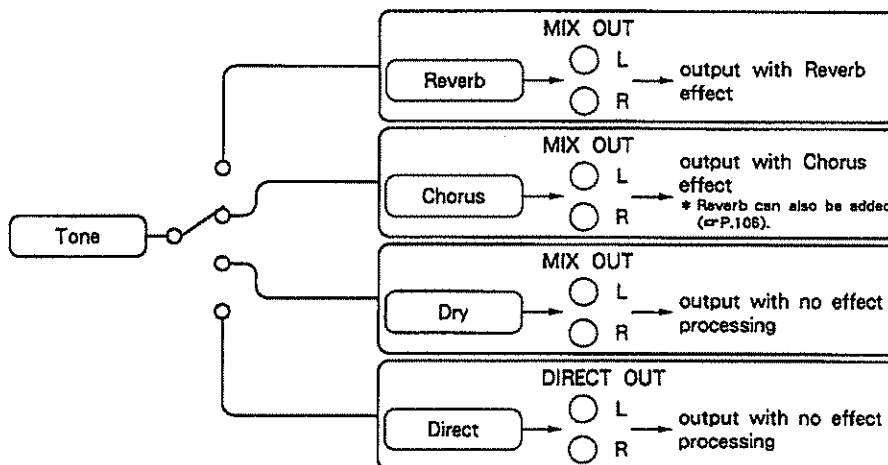

Pan

<Patch parameter>

Specify the pan (stereo position) of the Tone.

【Settings】 [7>]—[><]—[7<]

*Pan can be specified by a MIDI Pan message. Turn On the Pan Rx parameter of the Lower or Upper sections (☞ P.110).



7>6>5>4>3>2>1>><<1<2<3<4<5<6<7

Left ←————— Center —————→ Right

Tone

<Patch parameter>

Specify whether or not to mute the Tone. If this parameter is set Off, the Tone will be muted and will not sound.

【Settings】 [On] The Tone will sound.
 [Off] The Tone will be muted (will not sound):

Zone

<Patch parameter>

Specify the Zone that will be used when the Key Mode is Zone (☞ P.27).

【Setting】 [C-1]—[G9]

Tone Edit

14. Tone PRM

14. Tone PRM		*a11< 1>A.Piano 1	
[Part 1/1]*A11< 1>A.Piano	[L-1]		
Tone Name.....A.Piano 1	DLM.....Off		
Orig. Media.....I 1	Mode.....A		
Orig. Number.....1	Start... 2		
Orig. Name.....<A.Piano 1 >	Lensth.. 3		
T.PRM	Pitch	TVF	TVA
			LFO

Make settings for Tone parameters.

Part Number Select the Part you wish to edit. The Patch of the selected Part will be displayed. The KB PART will be displayed as the denominator, and will be displayed as "-" if turned Off.
 [1]— [5]

Section Select the Section you wish to edit.
 [L-1], [L-2], [U-3], [U-4]

* You can also select a Section by holding **TONE/ZONE SELECT** for the Section you wish to edit and pressing **EDIT**.

Tone Name <Tone parameter>
 A Tone can be given a 10-character name (☞ P.87).

Orig. Media (Original Tone Media) <Tone parameter>
 The Original Tone which is used will depend on two selections; the Original Tone Media and the Original Tone Number. This parameter specifies the Original Tone Media.
 Internal memory contains three Original Tone Media. In addition to this Internal data, you can use SN-SPLA series sound library Cards for the D-series, and U-series sound library Cards (SN-U110 series). (The Card number will be the Original Tone Media.)
[Settings] [1] — [3] (Internal), [D 1] — [D32] (SN-SPLA series), [U 1] — [U32] (SN-U110 series)

- * The D - 70 cannot use the following data of the U-series sound library Cards.
 - LATIN SETUP and F.X. SETUP from Card SN-U110-02 (Latin & F.X. Percussion)
 - 28.N.DANCE from Card SN-U110-08 (Synthesizer)
 - The Card SN-U110-10 (Rock Drums)
- * The D - 70 cannot use sound library ROM Cards for other D-series models (D-5/10/20/50/110/550) (PN-D10 series or PN-D50 series).

Orig. Number (Original Tone number) <Tone parameter>
 The Original Tone is determined by two parameters; the Original Tone Media and the Original Tone Number. Here you can select the Original Tone Number.
[Settings] [1] — [Number of Original Tones in the Media]

- * The Original Tone Number must be within the range of the Original Tones actually contained in the selected Original Tone Media.
- * When you select the Original Tone from Tone Edit mode, only the PCM wave of the Original Tone will change. If you wish to change the Original Tone parameters as well, execute the Tone Command Orig.Tone PRM (☞ P.158, 163).

Orig. Name (Original Tone Name)
The name of the Original Tone is displayed, but cannot be edited.

DLM (Differential Loop Modulation) <Tone parameter>
This creates a change in the sound that is unlike PCM. Set this as desired. For normal sounds, you will leave this Off.
[Settings] [On] (DLM), [Off] (PCM)

- * If DLM is turned On, the pitch will be affected. Use the Pitch Coarse and Pitch Fine parameters to adjust the pitch (☞ P.116).
- * Some Tones which use DLM may not sound over the entire keyboard range. Also, for some DLM settings, there may be no sound.
- * A Tone created by using the DLM may cause unstable pitch around the Upper Limit (the highest pitch to be played) of the Original Tone. For details about the Upper Limit, see page 188.

Mode (DLM Mode) <Tone parameter>
Specify the DLM mode. Set this as desired.
[Settings] [A], [B]

Start <Tone parameter>
Specify the Start Point from which the PCM wave will be read.
[Settings] [0] — [127]

Length <Tone parameter>
Specify the length (Loop Length) to be read from the PCM Wave.
[Settings] [1] — [128]

15. Tone Pitch

15. Tone Pitch		*all< 1>A.Piano	
[Part 1/1]*all< 1>A.Piano		[L-1]	
P. Coarse +12	DLM.....Off	Tim	Depth
P. Fine...+10	Mode.....A	A	0
P. KF...+100%	Start.....0	R	0
ENU KF...+100%	Length...127		
T. PRM	Pitch	TUF	TUR
			LFO

Make parameter settings to determine the pitch.

Part Number Select the Part you wish to edit. The Patch of the selected Part will be displayed. The KB PART will be displayed as the denominator, and will be displayed as "-" if turned Off.
[1] — [5]

Section Select the Section you wish to edit.
[L-1], [L-2], [U-3], [U-4]

* You can also select a Section by holding **TONE/ZONE SELECT** for the Section you wish to edit and pressing **EDIT**.

③ THE FUNCTIONS OF EACH DISPLAY (EDIT MODE)

P. Coarse (Pitch Coarse) <Tone parameter>
 Specify the pitch of the Tone in steps of a semi-tone (☐ P.111).
【Settings】 [-48 semi-tones] — [+48 semi-tones]

P. Fine (Pitch Fine) <Tone parameter>
 Specify the pitch of the Tone. A setting of 64 results in a semi-tone pitch difference (☐ P.111).
【Settings】 [-64] — [+63]

P. KF (Pitch Key Follow) <Tone parameter>
 Normally, the pitch will rise a semi-tone for each key, in equal-tempered steps. If desired, this pitch ratio can be changed. This allows you to create scales used in ethnic music, or the subtle differences in pitch found on an acoustic piano. The display will show the number of octaves of pitch change that will result from playing 12 keys.
【Settings】 [-100%], [-50%], [-20%], [-10%], [-5%], [0], [+5%], [+10%], [+20%], [+50%], [+98%], [+99%], [+100%], [+101%], [+102%], [+200%]

*When the P.KF is set to +200%, a certain key may not sound.
 *The adjustment is centered around the C4 key.

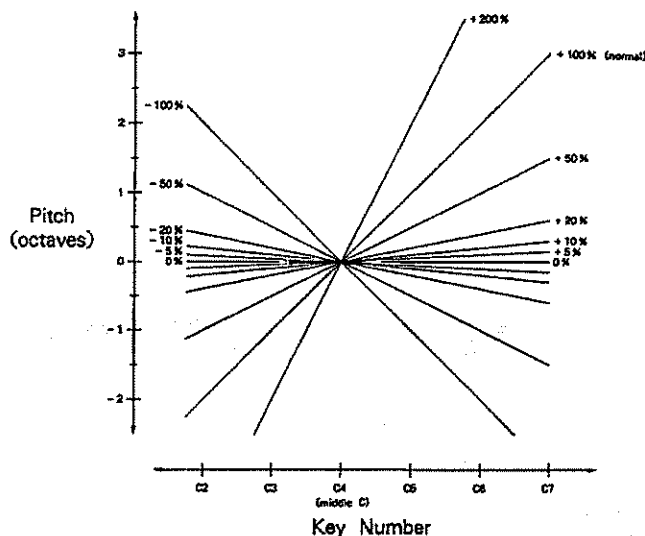

ENV KF (Envelope Time Key Follow) <Tone parameter>
 The Envelope Time (Attack and Release) can be made to change depending on key position.

【Settings】 [-100%], [-50%], [0], [+10%], [+20%], [+30%], [+40%], [+50%], [+60%], [+70%], [+80%], [+90%], [+100%], [+110%], [+130%], [+150%]

* The adjustment is centered around the C4 key.

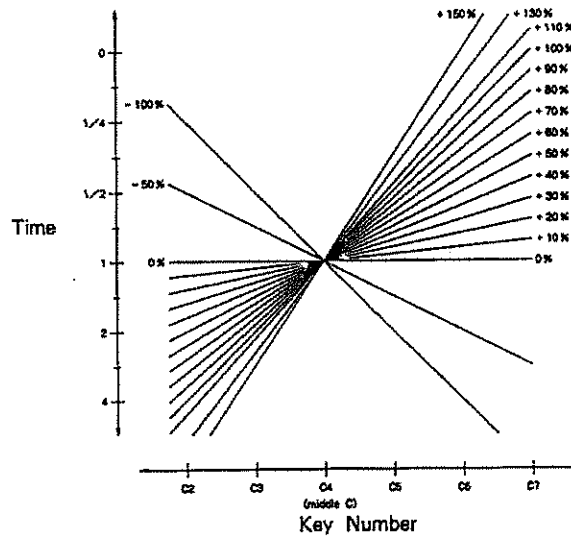

When ENV KF is +100%

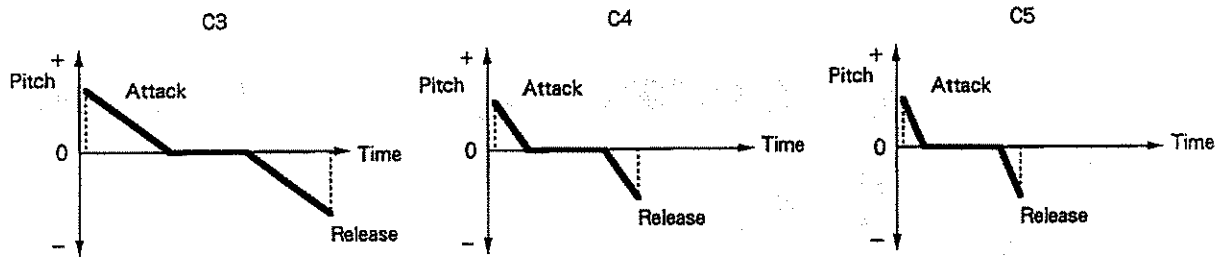

- DLM (Differential Loop Modulation) <Tone parameter>
You can edit the DLM setting made in the 14.Tone PRM display (P.115).
- Mode (DLM Mode) <Tone parameter>
You can edit the Mode setting made in the 14.Tone PRM display (P.115).
- Start <Tone parameter>
You can edit the Start setting made in the 14.Tone PRM display (P.115).
- Length <Tone parameter>
You can edit the Length setting made in the 14.Tone PRM display (P.115).

③ THE FUNCTIONS OF EACH DISPLAY (EDIT MODE)

Pitch Envelope

<Tone parameter>

These parameters determine how the pitch will change over time.

- [Settings]**
- Attack Time [0] — [127]
 - Attack Depth [-48], [-42], [-36], [-30], [-24], [-18], [-12] — [-1], [-0.5], [-0.25], [0], [+0.25], [+0.5], [+1] — [+12] semi-tone
 - Release Time [0] — [127]
 - Release Depth [-48], [-42], [-36], [-30], [-24], [-18], [-12] — [-1], [-0.5], [-0.25], [0], [+0.25], [+0.5], [+1] — [+12] semi-tone

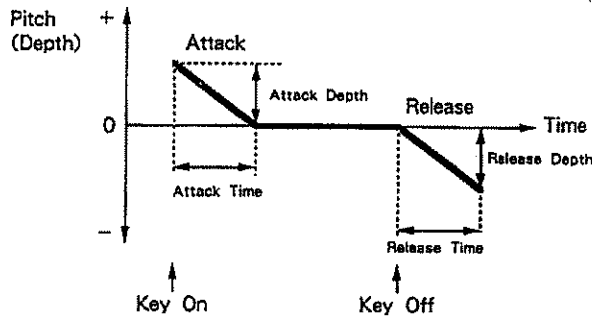

16. Tone TVF

16. Tone TVF		*a11< 1>A.Piano 1	
[Part 1/1]*a11< 1>A.Piano			[L-1]
Filter- LFF	ENV Depth+40		Tim LV1
Cutoff... 20	Uelo-127	A	12 127
Reso... 40	TIME KF- 0%	D/B	50 0
U.Curve... 1	Uelo- 30	D/S	50 127
KF... +100%	R.Uelo- 20	R	127
T.PRM	Pitch	TVF	TVA LFO

Make TVF settings.

Part Number

Select the Part you wish to edit. The Patch of the selected Part will be displayed. The KB PART will be displayed as the denominator, and will be displayed as "-" if Off.

[1] — [5]

Section

Select the Section you wish to edit.

[L-1], [L-2], [U-3], [U-4]

* You can also select a Section by holding **TONE/ZONE SELECT** for the Section you wish to edit and pressing **EDIT**.

Filter

(Filter Mode) <Tone parameter>

Specify the TVF Mode. The mode will determine the frequency range of the sound that will be heard.

- 【Settings】**
- [LPF] (Low Pass Filter) Begin cutting from the high frequency range.
 - [HPF] (High Pass Filter) Begin cutting from the low frequency range.
 - [BPF] (Band Pass Filter) Pass through only the specified frequency range.
 - [Bypass] (Bypass) The filter will not be used.

Low Pass Filter

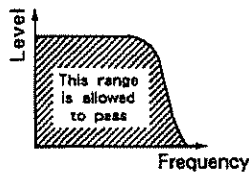

High Pass Filter

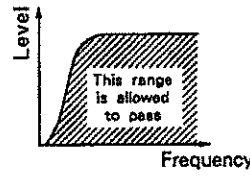

Band Pass Filter

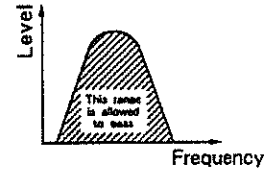

Cutoff

(Cutoff Frequency) <Tone parameter>

Specify the Cutoff Point as an absolute value for the entire TVF (P.112).

- 【Setting】** [0] — [127]

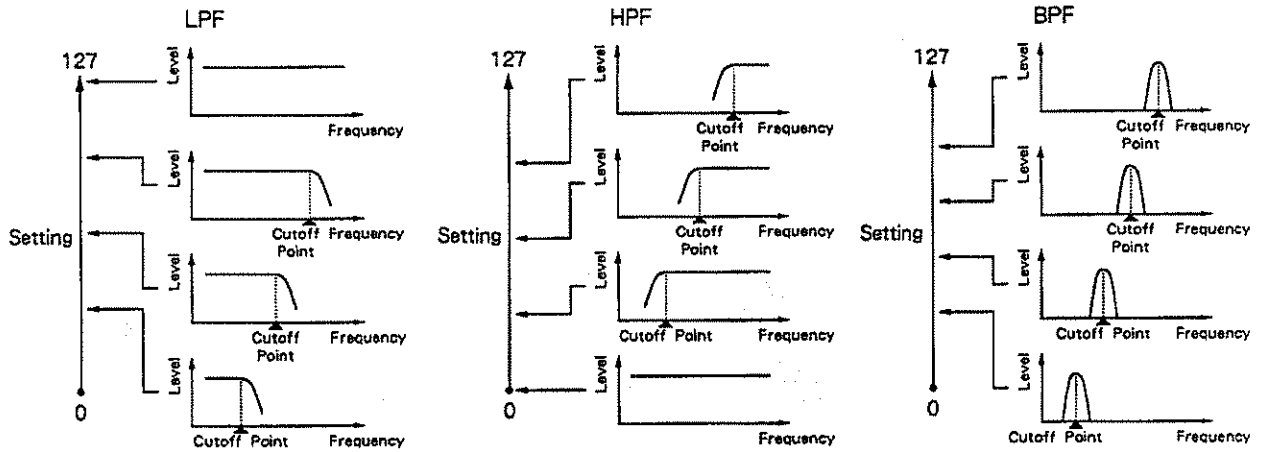

* Remember that this is also affected by the position of the Brightness slider (P.22).

* When the Filter is LPF, lower settings will result in a broader range of high frequencies being cut, and the sound will become similar to a sine wave. If this setting is too low, there will be no sound.

* When the Filter is HPF, higher settings will result in a broader range of low frequencies being cut.

* When the Filter is BPF, both the LPF and HPF filters will be applied.

Reso

(Resonance) <Tone parameter>

Specify the Resonance as an absolute value. Higher settings will create a greater emphasis in the frequency area of the Cutoff Frequency (☞ P.112).

[Setting] [0]—[127]

*When you play a chord with the Resonance set to a high value, the created sound may be distorted. If this happens, lower the level of the Tone Palette or level of the Tone. (see pages 111 and 124)

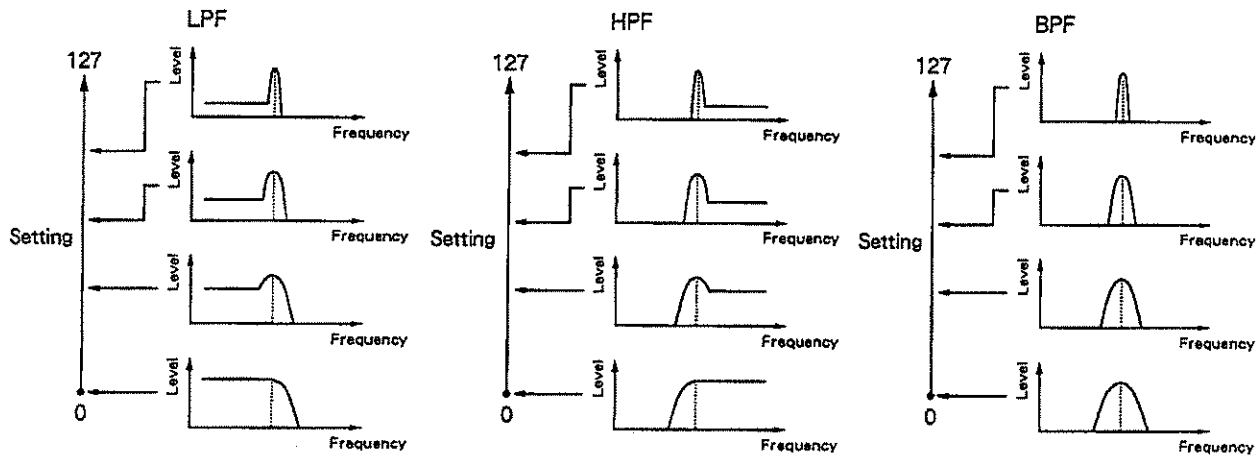

V. Curve

(Velocity Curve) <Tone parameter>

Specify how keyboard dynamics (velocity) will affect the Envelope Depth.

[1]—[4]

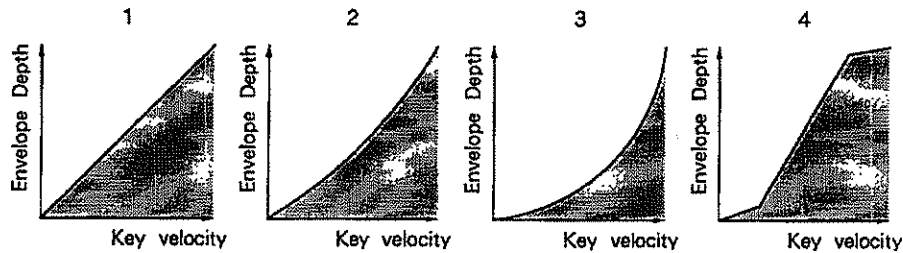

KF

(Cutoff Frequency Key Follow) <Tone parameter>

The Cutoff Frequency can be made to change according to the key position. The display indicates the number of octaves of change per 12 notes.

[Settings] [-100%], [-75%], [-50%], [-25%], [0], [+10%], [+20%], [+30%], [+40%], [+50%], [+60%], [+70%], [+80%], [+90%], [+100%], [+110%]

* The adjustment is centered around the C4 key.

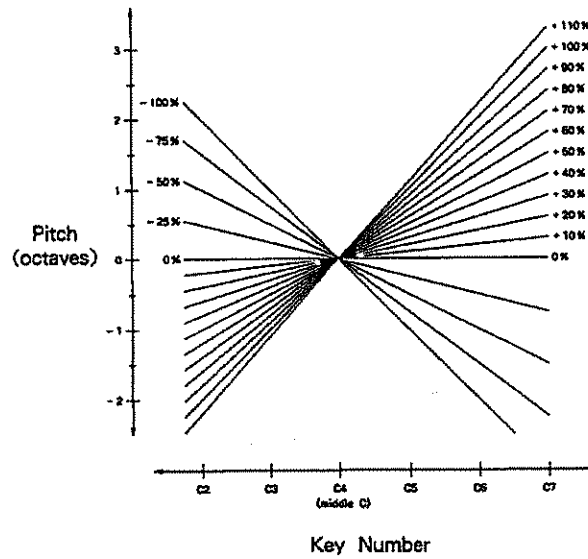

ENV Depth

(Envelope Depth) <Tone parameter>

Specify the depth of the Envelope that controls Cutoff Frequency. Higher settings will result in deeper control. Positive (+) and negative (-) settings will invert the Envelope.

[Settings] [-64] — [+63]

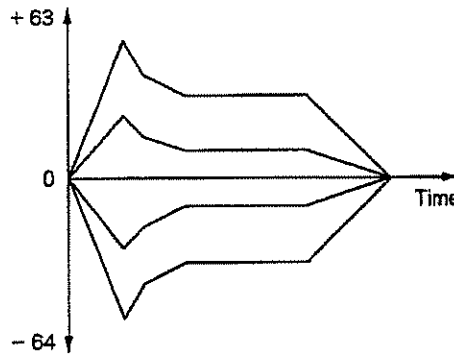

ENV Depth Velo

(Envelope Depth Velocity Sensitivity) <Tone parameter>

Specify how greatly key velocity will affect Envelope Depth. Higher settings will allow velocity to have a greater effect.

[Settings] [0] — [127]

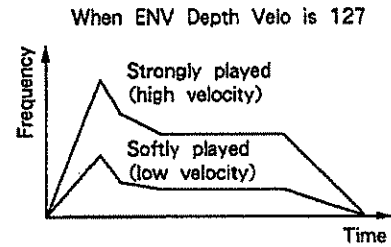
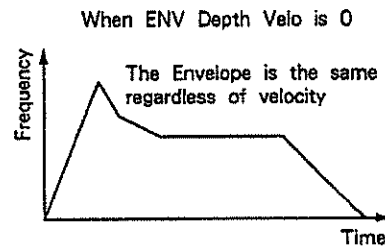

TIME KF

(Envelope Time Key Follow) <Tone parameter>

Envelope Time (Delay 1, Decay 2, Release) can be made to change according to key position.

[Settings] [-100%], [-50%], [0], [+10%], [+20%], [+30%], [+40%], [+50%], [+60%], [+70%], [+80%], [+90%], [+100%], [+110%], [+130%], [+150%]

* The adjustment is centered around the C4 key.

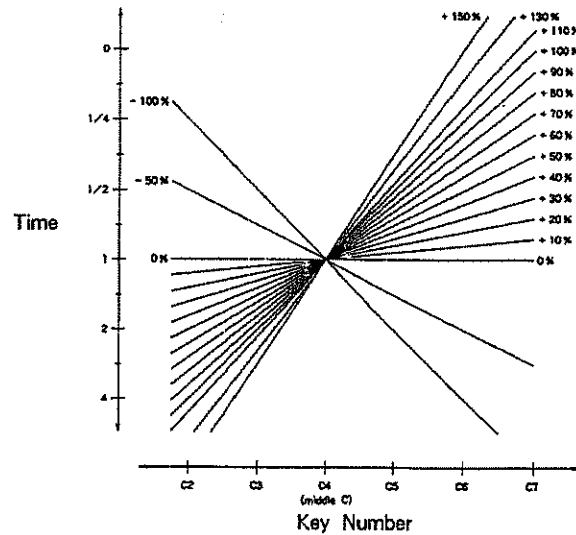

When TIME KF is +100%

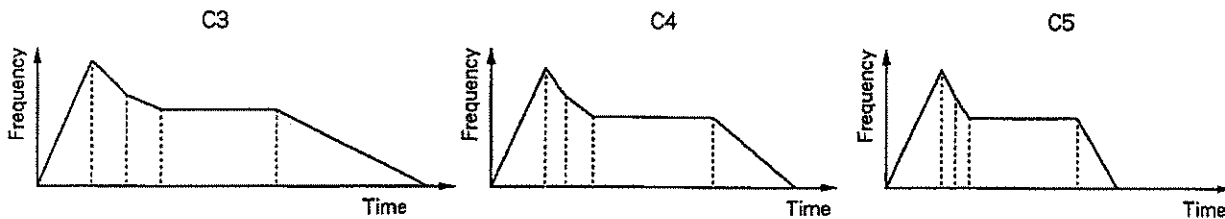

TIME Velo

(Envelope Time Velocity Sensitivity) <Tone parameter>

Envelope Time (Attack, Decay 1) can be made to change according to key velocity. Higher settings will allow velocity to have a greater effect.

[Settings] [0] — [127]

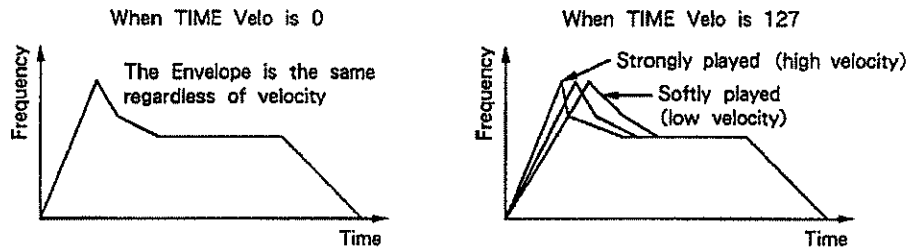

TIME R.Velo

(Envelope Time Release Velocity Sensitivity) <Tone parameter>

Release Time can be made to change according to the speed at which you release a key (release velocity). Higher settings will allow release velocity to have a greater effect.

[Settings] [0] — [127]

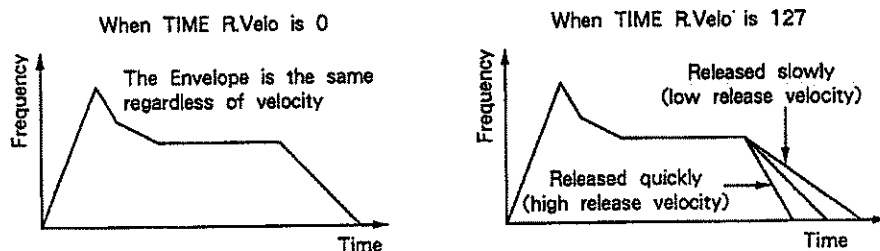

TVF Envelope

<Tone parameter>

The Cutoff Point can be made to change over time (OP.112).

[Settings] Attack Time [0] — [127]
 Attack Level [0] — [127]
 Decay 1 Time [0] — [127]
 Decay Break Point [0] — [127]
 Decay 2 Time [0] — [127]
 Sustain Level [0] — [127]
 Release Time [0] — [127]

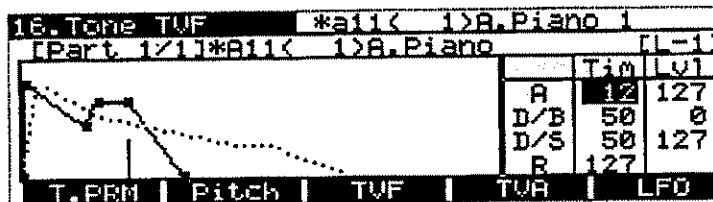
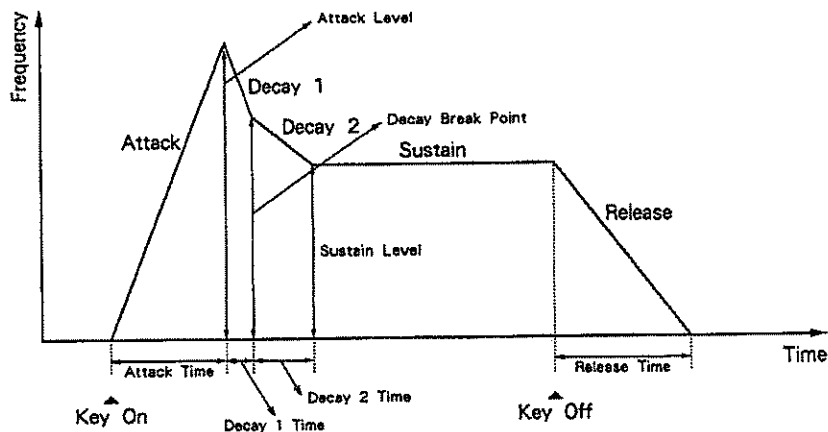

When you move the cursor to an Envelope parameter, the Envelope will automatically be displayed graphically. The solid line indicates the TVF Envelope, and the dashed line indicates the TVA Envelope. A vertical line is displayed at the key-off point, indicating the point at which the Release begins.

When you move the cursor to a parameter other than an Envelope parameter, the graphic display will automatically disappear.

17. Tone TVA

17. Tone TVA		*all< 1>A. Piano 1	
[Part 1/1]*A1< 1>A. Piano		[L-1]	
Level...127	TIME KF 0%	Tim	LV
V. Curve...1	Velo 0	A	80 127
V. Sens...127	R. Velo 0	D/B	80 80
		D/S	97 40
		R	87
T. PRM	Pitch	TVF	TVA
			LFO

Make TVA settings.

Part Number Select the Part you wish to edit. The Patch of the selected Part will be displayed. The KB PART will be displayed as the denominator, and will be displayed as "-" if turned Off.

[1]—[5]

Section Select the Section you wish to edit.

[L-1], [L-2], [U-3], [U-4]

* You can also select a Section by holding **TONE/ZONE SELECT** for the Section you wish to edit and pressing **EDIT**.

Level <Tone parameter>

Set the volume level of the voice.

[Settings] [0]—[127]

V. Curve (Velocity Curve) <Tone parameter>

Specify how volume will be affected by keyboard dynamics (velocity).

[Settings] [1]—[4]

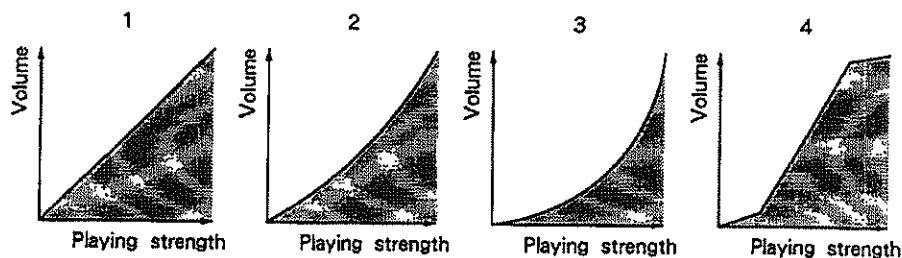

V. Sens (Velocity Sensitivity) <Tone parameter>

Specify how greatly volume will be affected by keyboard dynamics (velocity). With a setting of 127, velocity will have maximum effect on volume.

[Settings] [0]—[127]

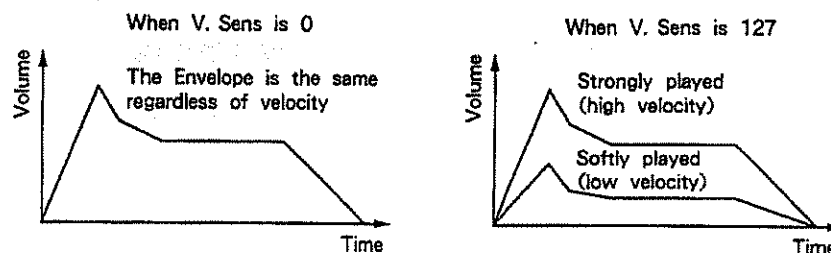

TIME KF

(Envelope Time Key Follow) <Tone parameter>

Envelope Time (Decay 1, Decay 2, Release) can be made to change according to key position.

[Settings] [-100%], [-50%], [0], [+10%], [+20%], [+30%], [+40%], [+50%], [+60%], [+70%], [+80%], [+90%], [+100%], [+110%], [+130%], [+150%]

*The adjustment is centered around the C4 key.

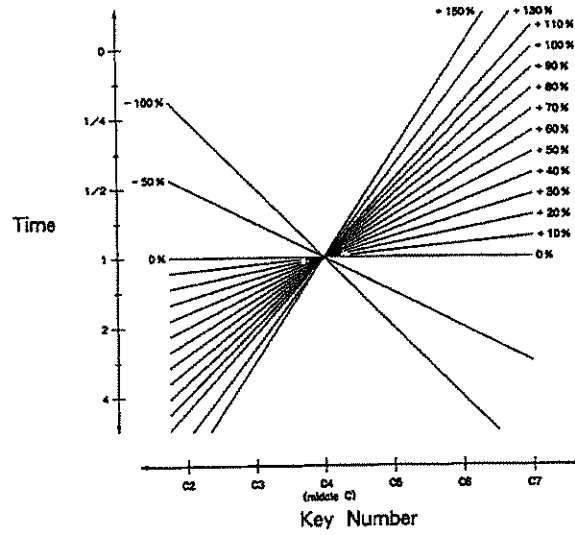

When TIME KF is +100%

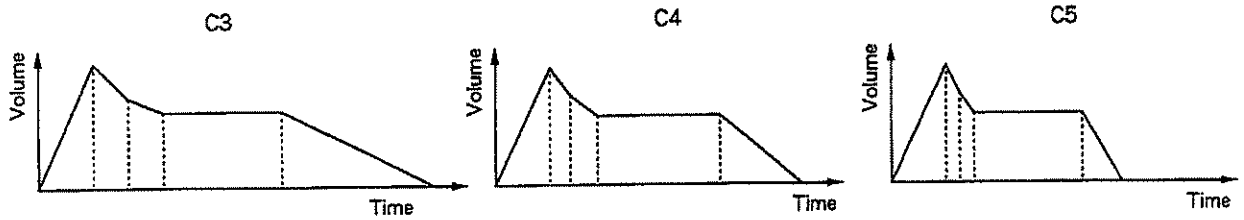

TIME Velo

(Envelope Time Velocity Sensitivity) <Tone parameter>

Envelope Time (Attack, Decay 1) can be made to change according to velocity. Higher settings will allow velocity to have a greater effect.

[Settings] [0] — [127]

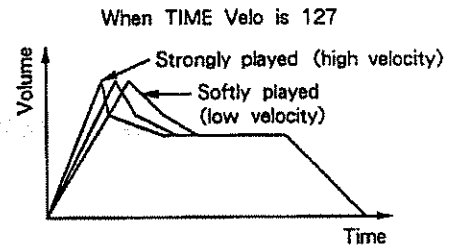
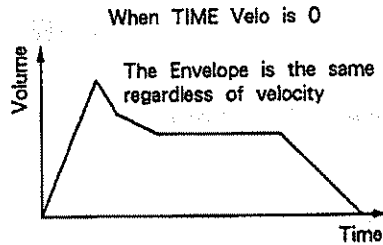

18. Tone LFO

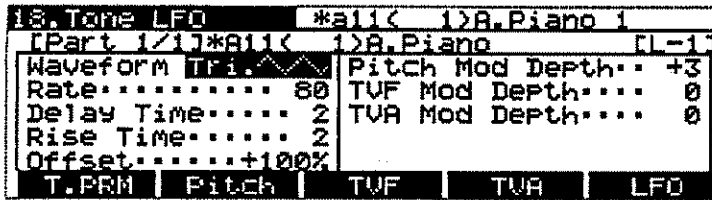

Make LFO settings. LFO settings allow you to apply modulation to the Pitch, TVF, and TVA.

Part Number Select the Part you wish to edit. The Patch of the selected Part will be displayed. The KB PART will be displayed as the denominator, and will be displayed as "-" if turned Off.

[1] — [5]

Section Select the Section you wish to edit.

[L-1], [L-2], [U-3], [U-4]

* You can also select a Section by holding **TONE/ZONE SELECT** for the Section you wish to edit and pressing **EDIT**.

Waveform <Tone parameter>

Select the LFO waveform.

[Settings] [Triangle], [Sine], [Square], [Saw], [Random]

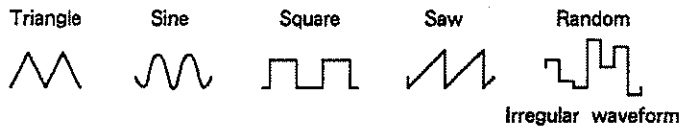

Rate (LFO Rate) <Tone parameter>

Specify the speed of the LFO. Higher settings will result in faster modulation.

[Settings] [0] — [127]

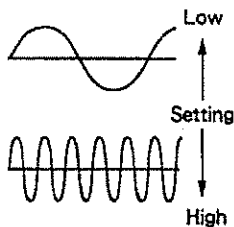

Delay Time <Tone parameter>

Specify the time from Key On (when you play the keyboard) to when modulation will begin to be applied.

[Settings] [0] — [15]

Rise Time

<Tone parameter>

Specify the time from when modulation begins to be applied to when it reaches the specified depth (Pitch Mod Depth, TVF Mode Depth, TVA Mod Depth).

【Settings】 [0]—[15]

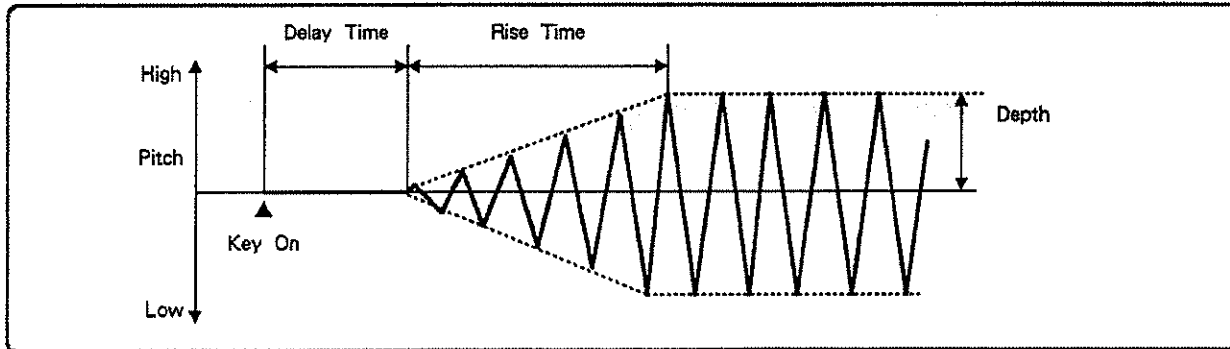

Offset

(LFO Offset) <Tone parameter>

The LFO waveform can be offset upward or downward.

【Settings】 [-100%], [-50%], [0%], [+50%], [+100%]

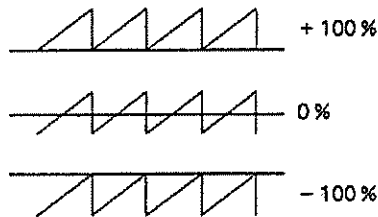

Pitch Mod Depth

(Pitch Modulation Depth) <Tone parameter>

Specify the depth at which Pitch will be modulated.

【Settings】 [-64]—[+63]

TVF Mod Depth

(TVF Modulation Depth) <Tone parameter>

Specify the depth at which TVF Cutoff Frequency will be modulated.

【Settings】 [-64]—[+63]

TVA Mod Depth

(TVA Modulation Depth) <Tone parameter>

Specify the depth at which TVA Volume will be modulated.

【Settings】 [-64]—[+63]

*For the Pitch Mod Depth, TVF Mod Depth, and TVA Mod Depth parameters, +/- settings will modify the waveform as shown in the following diagram.

When Offset = + 100 %

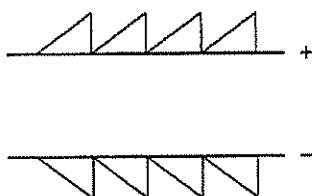

When Offset = 0 %

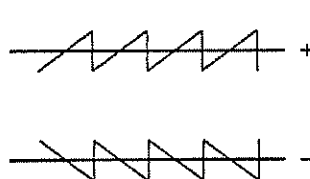

When Offset = - 100 %

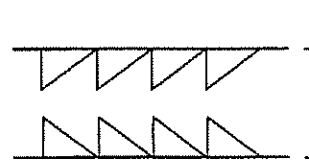

Rhythm Setup

19. Rhythm PRM

19. Rhythm PRM	
E 1 1	
Orig. Media.....I 3	Mute.....E#1
Orig. Number.....1	Out.....Reverb
Orig. Name.....<SNAREDRUM1>	Pan.....><
Source Key.....C 1	ENV.....No SUS
R.PRM	Pitch
TUF	TUA
Common	

Make Rhythm parameter settings for the Rhythm Tone of each key.

Key Number Select the Key Number you wish to edit.

[Settings] [E1] — [G7]

* You can also select a Key Number by holding a certain **TONE/ZONE SELECT** and pressing a key.

Orig. Media (Original Tone Media) <Rhythm Setup parameter>

This determines which Original Tone will be sounded by the key number you are editing. The Original Tone is selected by two parameters; the Original Tone Media and the Original Tone Number. Here you can select the Original Tone Media.

Internal memory contains three Original Tone Media. In addition to this Internal data, you can use SN-SPLA series sound library Cards for the D-series, and U-series sound library Cards (SN-U110 series). (The Card number will be the Original Tone Media.)

[Settings] [I 1] — [I 3] (Internal), [D 1] — [D32] (SN-SPLA series), [U 1] — [U32] (SN-U110 series)

* The D - 70 cannot use the following data of the U-series sound library Cards.

- LATIN SETUP and F.X. SETUP from Card SN-U110-02 (Latin & F.X. Percussion)
- 28.N.DANCE from Card SN-U110-08 (Synthesizer)
- The Card SN-U110-10 (Rock Drums)

* The D - 70 cannot use sound library ROM Cards for other D-series models (D-5/10/20/50/110/550) (PN-D10 series or PN-D50 series).

Orig. Number (Original Tone Number) <Rhythm Setup parameter>

Select the Original Tone that will be played by the key number being edited. The Original Tone is determined by two parameters; the Original Tone Media and the Original Tone Number. Here you can select the Original Tone Number.

[Settings] [1] — [Number of Original Tones in the Media]

* The Original Tone Number must be within the range of the Original Tones actually contained in the selected Original Tone Media.

* When you select the Original Tone from Tone Edit mode, only the PCM wave of the Original Tone will change.

Orig. Name (Original Tone Name)

The name of the Original Tone is displayed, but cannot be edited.

Source Key

<Rhythm Setup parameter>

Specify the Key at which the Original Tone selected for the Key Number of the currently edited Rhythm Setup will play. If this parameter is set to Off, the Rhythm Tone for that Key Number will be turned off, and will not sound.

[Settings] [Off], [C#-1] — [G9]

*Each Original Tone has an Upper limit to the pitches it can produce, and there will be no sound if this limit is exceeded. If you specify a Source Key that is beyond this limit, there will be no sound. For the pitch range of each Original Tone, refer to page 186.

(Example) The Key Number of the currently edited Rhythm Setup is E2, and a Source Key of A2 has been specified.

Key Number of the Rhythm Setup



Key Number of the Original Tone
(Source Key)

Mute

<Rhythm Setup parameter>

This function mutes the sound of the specified key.

[Settings] [E1] — [G7] The sound of the specified key will be muted.
[Off] Muting will not occur.

(Example) An unnatural effect will be produced if both the Closed Hi-hat (F#2 key) and Open Hi-hat (A#2 key) sound together. In this case, set the F#2 key to mute the A#2 key, and set the A#2 key to mute F#2. With these settings, when one is played, the other will be turned off.

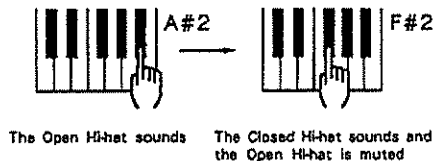

Out

(Output Assign) <Rhythm Setup parameter>

Specify how the effects will be added to the Rhythm Tone.

[Settings] [Reverb], [Chorus], [Dry], [Direct]

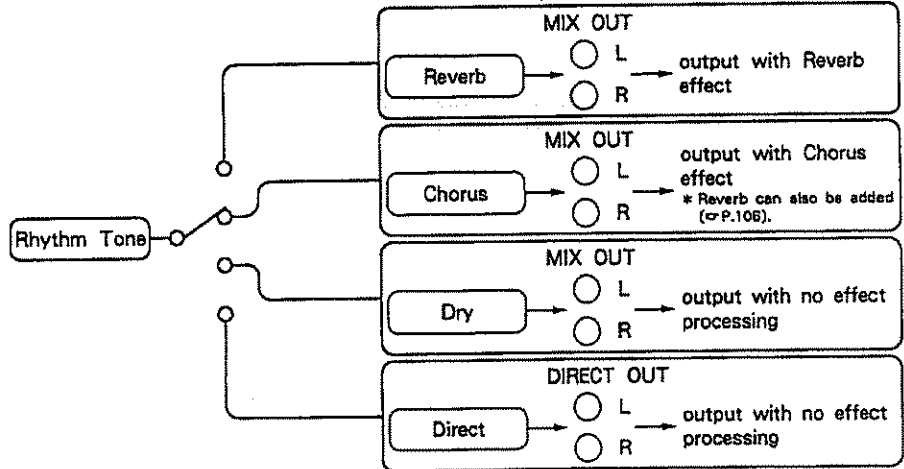

Pan

<Rhythm Setup parameter>

Specify the pan (stereo position) of the Rhythm Tone when stereo output is used.

[Settings] [7>] — [><] — [7<]



7 > 6 > 5 > 4 > 3 > 2 > 1 >> << 1 < 2 < 3 < 4 < 5 < 6 < 7

Left ← Center → Right

ENV

(Envelope Mode) <Rhythm Setup parameter>

Specify whether or not Sustain will apply to the TVF and TVA Envelopes.

[Settings] [Sus] (Sustain) Release will begin when the Note Off message is received.
 [No Sus] (No Sustain) Note Off messages will be ignored.

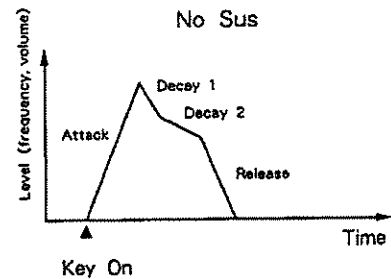
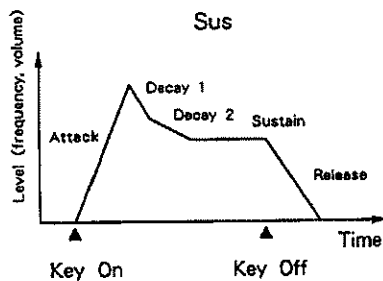

20. Rhythm Pitch

20. Rhythm Pitch I 3/ 1/ SNAREDRUM1/C 1				
P E 1				
P.Coarse	0		Tim	Depth
P.Fine	+13		A	0
				0
R.PRM	Pitch	TUF	TVA	Common

Specify the Pitch for the Rhythm Tone of each key.

Key Number Select the Key Number you wish to edit.

[E1] — [G7]

* You can also select a Key Number by holding a certain **TONE/ZONE SELECT** and pressing a key.

P.Coarse (Pitch Coarse) <Rhythm Setup parameter>

Specify the pitch of the Rhythm Tone in semi-tone steps.

[Settings] [- 12 semi-tones] — [+12 semi-tones]

P.Fine (Pitch Fine) <Rhythm Setup parameter>

Specify the pitch of the Rhythm Tone in fine steps. A setting of 64 results in a semi-tone pitch change.

[Settings] [- 64] — [+63]

Pitch Envelope <Rhythm Setup parameter>

The pitch can be made to change over time.

[Settings] Attack Time [0] — [127]
 Attack Depth [- 48], [- 42], [- 36], [- 30], [- 24], [- 18], [- 12] — [- 1], [- 0.5], [- 0.25], [0], [+0.25], [+0.5],
 [+1] — [+12] semi-tone

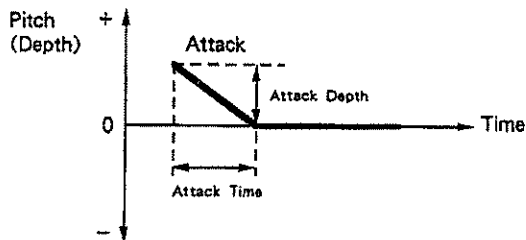

21. Rhythm TVF

21. Rhythm TVF		I 3/ 1/ SNAREDRUM1/C 1	
[E 1]			
Filter	LPF	ENV Depth	+40
Cutoff	20	Veloc	0
Reso	50		
V. Curve	1		
		Tim	LU1
		A	82 127
		D/B	50 127
		D/S	50 127
		R	127
R.PRM	Filter	TVF	TVR
			Common

Set the TVF for the Rhythm Tone of each key.

Key Number

Select the Key Number you wish to edit.

[E1] — [G7]

* You can also select a Key Number by holding a certain **TONE/ZONE SELECT** and pressing a key.

Filter

(Filter Mode) <Rhythm Setup parameter>

Set the TVF Mode. The mode will determine the frequency range of the sound that will be heard (☞ P.119).

- [Settings]
- [LPF] (Low Pass Filter) Begin cutting from the high frequency range.
 - [HPF] (High Pass Filter) Begin cutting from the low frequency range.
 - [BPF] (Band Pass Filter) Pass through only the specified frequency range.
 - [Bypass] (Bypass) The filter will not be used.

Cutoff

(Cutoff Frequency) <Rhythm Setup parameter>

Specify the Cutoff Point for the entire TVF (☞ P.119).

[Setting] [0] — [127]

- * Remember that this is also affected by the position of the Brightness slider (☞ P.22).
- * When the Filter is LPF, lower settings will result in a broader range of high frequencies being cut, and the sound will become similar to a sine wave. If this setting is too low, there will be no sound.
- * When the Filter is HPF, higher settings will result in a broader range of low frequencies being cut.
- * When the Filter is BPF, both the LPF and HPF filters will be applied.

Reso

(Resonance) <Rhythm Setup parameter>

Specify the Resonance. Higher settings will create a greater emphasis in the frequency area of the Cutoff Frequency (☞ P.120).

[Setting] [0] — [127]

- * When you play a chord with the Resonance set to a high value, the created sound may be distorted. If this happens, lower the level of the Rhythm Tone. (see pages 134)

V. Curve

(Velocity Curve) <Rhythm Setup parameter>

Specify how keyboard dynamics (velocity) will affect the Envelope Depth (☞ P.120).

[1] — [4]

ENV Depth

(Envelope Depth) <Rhythm Setup parameter>

Specify the depth of the Envelope that controls Cutoff Frequency. Higher settings will result in deeper control. Positive (+) and negative (-) settings will invert the Envelope (☞ P.121).

[Settings] [-64] — [+63]

③ THE FUNCTIONS OF EACH DISPLAY (EDIT MODE)

ENV Depth Velo (Envelope Depth Velocity Sensitivity) <Rhythm Setup parameter>
Specify how greatly key velocity will affect Envelope Depth. Higher settings will allow velocity to have a greater effect (☞ P.121).

[Settings] [0] — [127]

TVF Envelope <Rhythm Setup parameter>
The Cutoff Point can be made to change over time (☞ P.123).

[Settings]

Attack Time	[0] — [127]
Attack Level	[0] — [127]
Decay 1 Time	[0] — [127]
Decay Break Point	[0] — [127]
Decay 2 Time	[0] — [127]
Sustain Level	[0] — [127]
Release Time	[0] — [127]

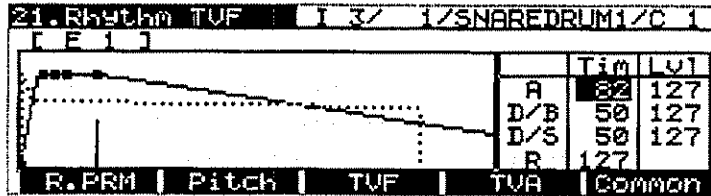

When you move the cursor to an Envelope parameter, the Envelope will automatically be displayed graphically. The solid line indicates the TVF Envelope, and the dashed line indicates the TVA Envelope. A vertical line is displayed at the key-off point, indicating the point at which the Release begins.

When you move the cursor to a parameter other than an Envelope parameter, the graphic display will automatically disappear.

22. Rhythm TVA

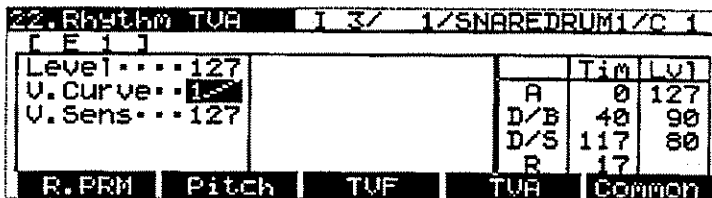

Make TVA settings for the Rhythm Tone of each key.

Key Number Select the Key Number you wish to edit.
[E1] — [G7]

* You can also select a Key Number by holding a certain **TONE/ZONE SELECT** and pressing a key.

Level <Rhythm Setup parameter>
Set the volume level.
[Settings] [0] — [127]

V. Curve

(Velocity Curve) <Rhythm Setup parameter>

Specify how volume will be affected by keyboard dynamics (velocity) (☞ P.124).

[Settings] [1]—[4]

V. Sens

(Velocity Sensitivity) <Rhythm Setup parameter>

Specify how greatly volume will be affected by keyboard dynamics (velocity). With a setting of 127, velocity will have maximum effect on volume (☞ P.124).

[Settings] [0]—[127]

TVA Envelope

<Rhythm Setup parameter>

The volume can be made to change over time (☞ P.126).

[Settings]

Attack Time	[0]—[127]
Attack Level	[0]—[127]
Decay 1 Time	[0]—[127]
Decay Break Point	[0]—[127]
Decay 2 Time	[0]—[127]
Sustain Level	[0]—[127]
Release Time	[0]—[127]

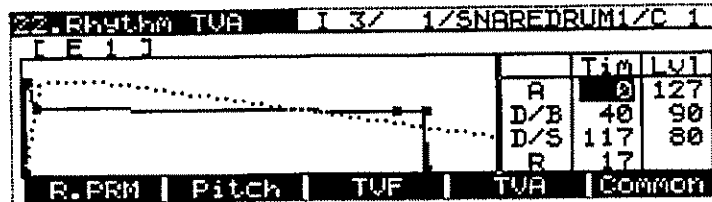

When you move the cursor to an Envelope parameter, the Envelope will automatically be displayed graphically. The solid line indicates the TVA Envelope, and the dashed line indicates the TVF Envelope. A vertical line is displayed at the key-off point, indicating the point at which the Release begins. When you move the cursor to a parameter other than an Envelope parameter, the graphic display will automatically disappear.

23. Rhythm Common

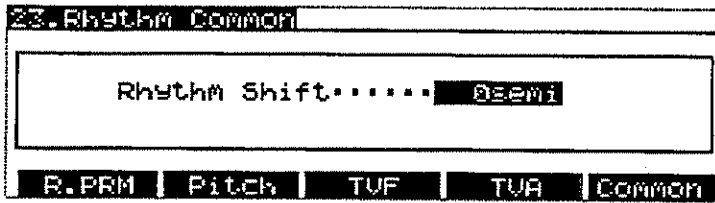

Make settings for Rhythm Common data (parameters which affect the entire Rhythm Setup).

Rhythm Shift

<Rhythm Setup parameter>

Shift all the Key Numbers of the Rhythm Setup.

[Settings] [-28 semi-tone] — [+24 semi-tone]

* The Note Numbers specified for Mute will also be shifted.



System Setup

24. System Setup

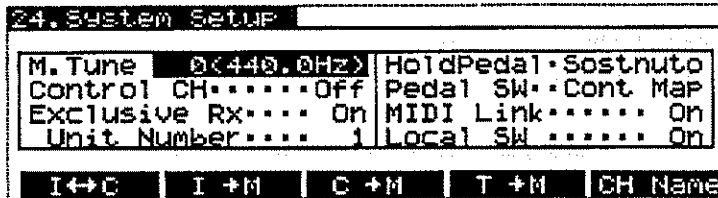

Make System Setup settings.

M. Tune (Master Tune) <System Setup parameter>
 Adjust the tuning of all Parts. The frequency of the note A4 can be adjusted over the range of 415.4 — 465.8 Hz. For a setting of 0, A4 will be 440 Hz. A value change of 64 for this parameter results in a semi-tone of pitch change.
[Settings] [-64] — [0] — [+63]

Control CH (Control Channel) <System Setup parameter>
 Specify the MIDI Channel on which Program Change messages will be received to select Performances, and on which Program Change messages will transmitted when you select a Performance (☞ P.49).
[Settings] [1] — [16], [Off]

- * Control Channel can be used only in the Play Mode.
- * The Control Channel cannot be set to the same number as the Part channels or MIDI OUT channels. If it is set to the same number, it will be turned off and therefore cannot be used, while the display will continue to show the Control Channel number. It is convenient to edit the MIDI Channel settings in the CH Setting display (☞ P.157, 162).

● Here are some special ways in which the Control Channel can be used. For example, a sequencer recording of your playing on the D-70 using the internal sounds can be played back by the sequencer to use the very same sounds, if you use the following procedure.
 Set the sequencer in recording mode, press **PLAY**, and select a Performance on the D-70. Then begin playing. Playback the sequencer recording as usual.
 Or, you can begin recording with the D-70 in the condition immediately after its power was turned on. When playing back, turn the D-70 power off and on again before beginning playback. If the Control Channel is Off, recording or playback will not be possible.

Exclusive Rx (Exclusive Receive switch) <System Setup Parameter>
 Specify whether or not to receive System Exclusive messages (Roland ID only) that are sent to MIDI IN.
[Settings] [On] Receive
 [Off] Ignore
 * This will receive Exclusive messages regardless of the setting of the Protect Switch on the rear panel.

Unit Number <System Setup parameter>
 Specify the unit number with which Exclusive messages (Roland ID only) will be transmitted and received. For Exclusive messages to be transmitted and received, the unit numbers must match.
[Settings] [1] — [32]

* The MIDI Device ID is the Unit Number minus 1.

③ THE FUNCTIONS OF EACH DISPLAY (EDIT MODE)

Hold Pedal

<System Setup parameter>

Specify how the Hold pedal will affect the D - 70 itself (Internal).

* Hold messages will be transmitted from MIDI OUT regardless of this setting.

- [Settings]** [Hold] The pedal will function as a Hold pedal.
 [Sostenuto] The pedal will function as a Sostenuto pedal.

* Specify the Destination in the Controller Map of the KB PART and MIDI OUT (☞ P.89, 101).

Pedal SW

(Pedal Switch) <System Setup parameter>

Specify the function of the Pedal SW. The Pedal SW works only in the User set screen.

- [Settings]** [Perform ↑] (Performance up) The Performance registered to the Function Button will switch from the left to right within the User Set group currently selected.
 [Perform ↓] (Performance down) The Performance registered to the Function Button will switch from the right to left within the User Set group currently selected.
 [Effector] When the pedal is pressed On, the effector will be applied to each Part in the Performance whose Effect parameter is On (☞ P.99).
 [Cont Map] (Controller Map) The pedal will function as specified by the Keyboard parameters or MIDI OUT Controller Maps (☞ P.86, 101).

MIDI Link

(MIDI OUT Link Mode) <System Setup parameter>

Specify how MIDI OUT data of a Performance will be handled when a Performance is selected.

- [Settings]** [On] When a Performance is selected, the MIDI OUT parameters of the newly selected Performance will be read into the Temporary area.
 [Off] Even when a Performance is selected, the MIDI OUT parameters of the previous Performance will remain in the Temporary area, and the MIDI OUT settings will not change.

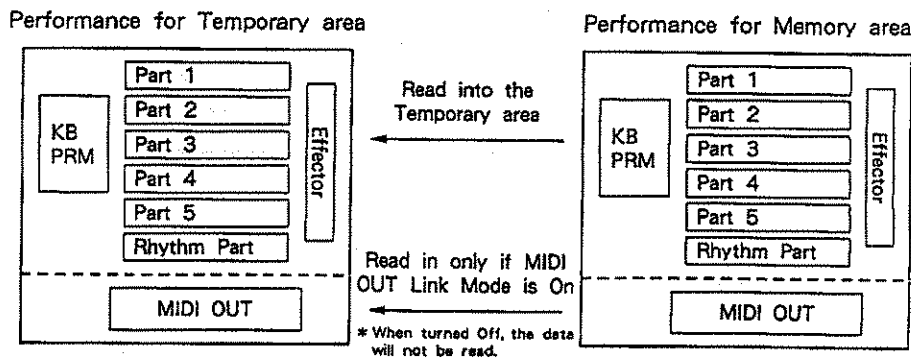

* If MIDI OUT Link Mode is Off, remember that if you select a Performance and edit and write it, the MIDI OUT parameters of the previously selected Performance will be written into the writing Destination.

Local SW (Local Switch) <System Setup parameters>
Turn the Local Switch on/off.

- [Settings]** [On] The keyboard is connected to the Part.
[Off] The keyboard is not connected to the Part, but is connected only to MIDI OUT (the MIDI Palette). Even if you select a Performance, the keyboard and Part will always remain unconnected. Use this Off setting when using the D - 70 to record on a sequencer, etc.

25. D.Xfer I ↔ C

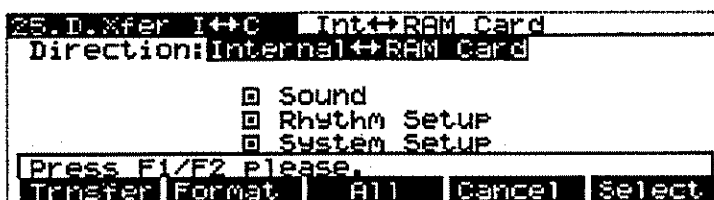

Transfer data between Internal memory and RAM Card memory.

Direction Specify the direction of data transfer.

- [Internal → RAM Card] Transfer data from Internal memory to RAM Card memory.
[Internal ← RAM Card] Transfer data from RAM Card memory to Internal memory.
[Internal ↔ RAM Card] Exchange data between Internal memory and RAM Card memory.

■ Select data

Select the data to be transferred.

Internal	RAM card																																				
<table border="1"> <tr><td colspan="2">Sound</td></tr> <tr><td>User Sets</td><td>10</td></tr> <tr><td>Performances</td><td>64</td></tr> <tr><td>Patches</td><td>128</td></tr> <tr><td>Tones</td><td>128</td></tr> <tr><td colspan="2">Rhythm Setup</td></tr> <tr><td>Rhythm Setup</td><td>1</td></tr> <tr><td colspan="2">System Setup</td></tr> <tr><td>System Setup</td><td>1</td></tr> </table>	Sound		User Sets	10	Performances	64	Patches	128	Tones	128	Rhythm Setup		Rhythm Setup	1	System Setup		System Setup	1	<table border="1"> <tr><td colspan="2">Sound</td></tr> <tr><td>User Sets</td><td>10</td></tr> <tr><td>Performances</td><td>64</td></tr> <tr><td>Patches</td><td>128</td></tr> <tr><td>Tones</td><td>128</td></tr> <tr><td colspan="2">Rhythm Setup</td></tr> <tr><td>Rhythm Setup</td><td>1</td></tr> <tr><td colspan="2">System Setup</td></tr> <tr><td>System Setup</td><td>1</td></tr> </table>	Sound		User Sets	10	Performances	64	Patches	128	Tones	128	Rhythm Setup		Rhythm Setup	1	System Setup		System Setup	1
Sound																																					
User Sets	10																																				
Performances	64																																				
Patches	128																																				
Tones	128																																				
Rhythm Setup																																					
Rhythm Setup	1																																				
System Setup																																					
System Setup	1																																				
Sound																																					
User Sets	10																																				
Performances	64																																				
Patches	128																																				
Tones	128																																				
Rhythm Setup																																					
Rhythm Setup	1																																				
System Setup																																					
System Setup	1																																				

*The Rhythm Setup and System Setup data in RAM Card is for storage purposes only, and cannot be played.

Sound, Rhythm Setup, System Setup

F5 **Select**

Place the cursor on the data you wish to transfer, and press **F5**. Each time you press the button, the data will alternately be selected (display) or un-selected (display).

F3 **All**

Select all data.

F4 **Cancel**

Cancel all selections of data.

■ Executing data transfer

F1 **Transfer**

Press **F1**. The display will ask "Are you sure? Press ENTER please.". If you are sure you want to transfer the data, press **ENTER**. To cancel without transferring, press **EXIT**.

- *When transferring Internal \Rightarrow RAM Card, make sure that the Protect Switch of the RAM Card is Off. Return the switch to the On position after transferring the data.
- *When transferring Internal \Leftarrow RAM Card, make sure that the Protect Switch on the D-70 rear panel is Off. Return the switch to the On position after transferring the data.
- *When transferring Internal \leftrightarrow RAM Card, make sure that the Protect Switch on the D-70 rear panel and the Protect Switch of the RAM Card are Off. Return the switches to the On position after transferring the data.

■ Formatting a RAM Card

This operation formats a RAM Card for use by the D-70. Data cannot be transferred to a RAM Card which has never been used or has been used by another device. When you execute the Format operation, the Internal memory data for Sound, Rhythm Setup and System Setup will automatically be transferred into the RAM Card.

- *When you execute the Format operation, all data that was previously in the RAM Card will be lost.
- *Use M-256E RAM Cards (sold separately).

F2 **Format**

Press **F2**. The display will ask "Are you sure? Press ENTER please.". If you are sure you want to format the RAM Card, press **ENTER**. To exit without formatting, press **EXIT**.

- *Before formatting a RAM Card, make sure that the Protect Switch on the RAM Card is in the Off position.

26. D.Xfer I → M

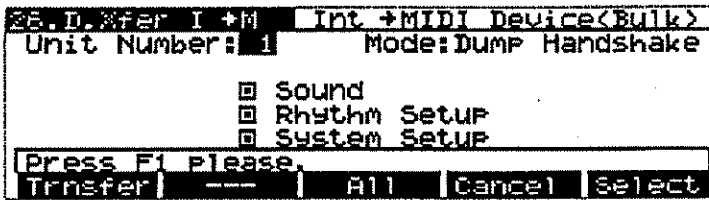

Transfer Internal memory data to an external MIDI device.

Unit Number

<System Setup parameter>

This allows you to edit the Unit Number specified in the 24. System Setup display (P.137). When transmitting or receiving System Exclusive data, make sure that both units are set to the same Unit Number.

[Settings] [1] — [32]

Mode

Specify the method of transferring System Exclusive data.

[Dump One Way]

Data will be transmitted regardless of the condition of the receiving device. This procedure is simpler, but takes a bit longer than the Dump Handshake method.

[Dump Handshake]

Transmit the data after confirming that the receiving device is ready to receive.

One Way connections

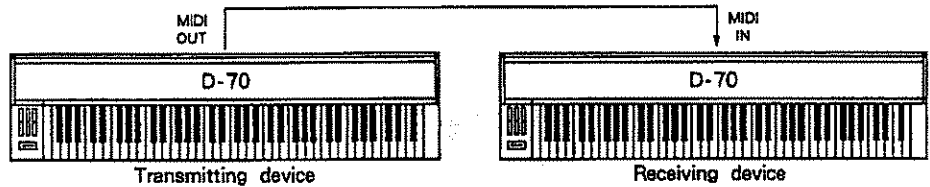

Handshake connections

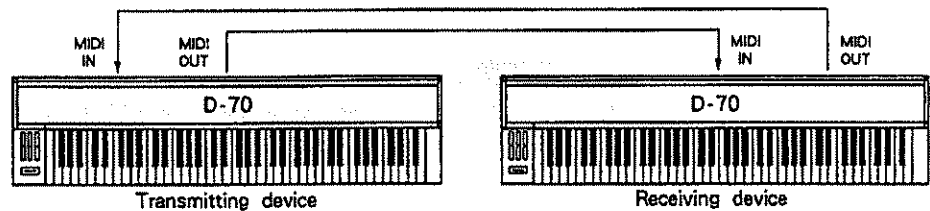

■ Select data

Select the data to be transmitted.

Internal

Sound	
User Sets	10
Performances	64
Patches	128
Tones	128
Rhythm Setup	1
System Setup	1

Sound, Rhythm Setup, System Setup

F5 **Select**

Place the cursor on the data you wish to transfer, and press **F5**. Each time you press the button, the data will alternately be selected (display) or un-selected (display).

F3 **All**

Select all data.

F4 **Cancel**

Cancel all selections of data.

■ Executing data transfer

F1 **Trnsfer**

Press **F1**. The display will ask "Are you sure? Press ENTER please.". If you are sure you want to transfer the data, press **ENTER**. To cancel without transferring, press **EXIT**.

27. D.Xfer C → M



Transfer data from RAM Card to an external MIDI device.

Unit Number

<System Setup parameter>

This allows you to edit the Unit Number specified in the 24. System Setup display (P.137). When transmitting or receiving System Exclusive data, make sure that both units are set to the same Unit Number.

[Settings] [1] — [32]

Mode

Specify the method of transferring System Exclusive data.

- [Dump One Way]** Data will be transmitted regardless of the condition of the receiving device. This procedure is simpler, but takes a bit longer than the Dump Handshake method.
- [Dump Handshake]** Transmit the data after confirming that the receiving device is ready to receive.

One Way connections

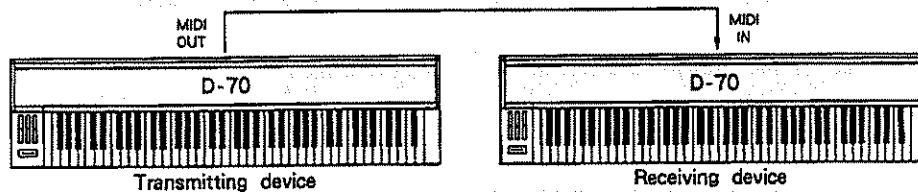

Handshake connections

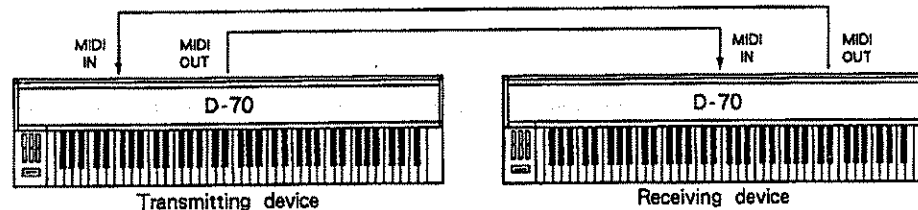

■ Select data

All data except System Setup in the RAM Card will be transferred.

RAM card

Sound	
User Sets	10
Performances	64
Patches	128
Tones	128
Rhythm Setup	1

■ Executing data transfer

F1 Transfer

Press **F1**. The display will ask "Are you sure? Press ENTER please.". If you are sure you want to transfer the data, press **ENTER**. To cancel without transferring, press **EXIT**.

28. D.Xfer T → M

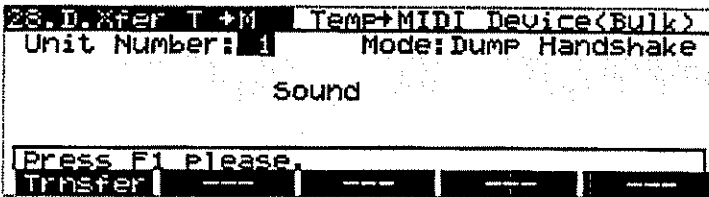

Transfer data from the Temporary area to an external MIDI device.

Unit Number

<System Setup parameter>

This allows you to edit the Unit Number specified in the 24.System Setup display (P.137). When transmitting or receiving System Exclusive data, make sure that both units are set to the same Unit Number.

【Settings】 [1] — [32]

Mode

Specify the method of transferring System Exclusive data.

[Dump One Way] Data will be transmitted regardless of the condition of the receiving device. This procedure is simpler, but takes a bit longer than the Dump Handshake method.

[Dump Handshake] Transmit the data after confirming that the receiving device is ready to receive.

One Way connections

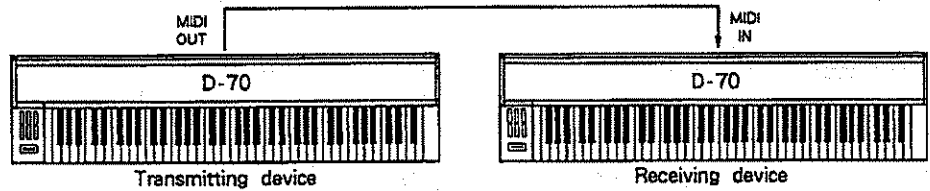

Handshake connections

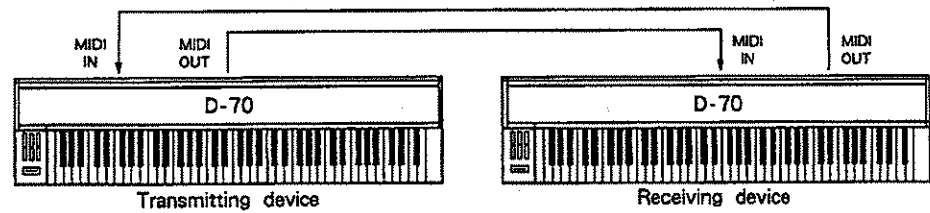

■ Select data

All data in the temporary area will be transferred.

Temporary area

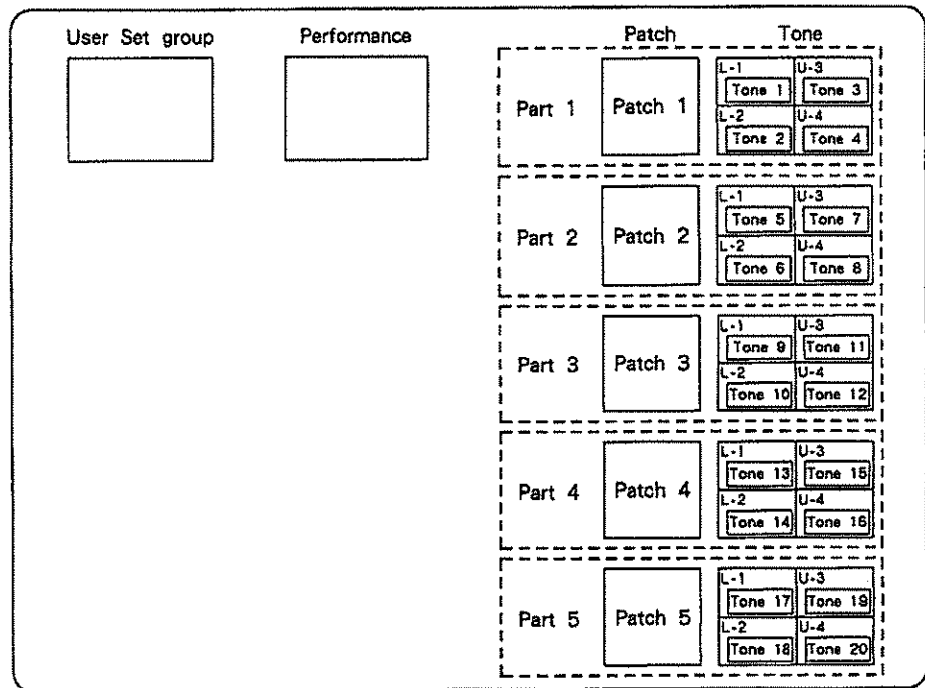

■ Executing data transfer

F1 Transfer

Press **F1**. The display will ask "Are you sure? Press ENTER please." If you are sure you want to transfer the data, press **ENTER**. To cancel without transferring, press **EXIT**.

29. Tx CH Name

29. TX CH NAME		
1: D-70II	6:	11:
2: S-770A	7:	12:
3: MKS-60	8:	13:
4: D-550	9:	14:
5:	10: R-8	15:
		16:
End	INIT	---

Specify a name for the channel of each Section of MIDI OUT.

Channel Name (1 — 16) <System Setup parameter>

You may specify a 10-character name (P.87).

F1 End

In the channel you are editing, fill all spaces following the cursor with blanks.

F2 INIT

In the channel you are editing, set each space to a blank character and return the cursor to the first character.

4 PCM CARD MODE

When the **PLAY** indicator is lit, you can press **PCM CARD** to listen to the Original Tones of PCM Card or Internal memory.

Orig.Tone<PCM>Play		Internal<I 1>	
1.A.Piano 1	6.A.Piano 6		
2.A.Piano 2	7.A.Piano 7		
3.A.Piano 3	8.A.Piano 8		
4.A.Piano 4	9.A.Piano 9		
5.A.Piano 5	10.A.Piano 10		
Slot A	Slot B	INT	-10 +10

* To return to Play mode, press **PLAY**.

(Note) When you return to Play mode from this display, all previous data in the Temporary area will be lost. If you wish to keep the data in the Temporary area, use the Write operation before entering the Orig.Tone (PCM) Play display (⇐ P.81, 150).

■ To select an Original Tone

To select an Original Tone, you must specify the Original Tone Media and the Original Tone Number.

① Select the Original Tone Media.

- F1** Select the Card inserted into Card slot A.
- F2** Select the Card inserted into Card slot B.
- F3** Select an Original Tone Media from Internal memory. Each time you press this button, the selection will alternate between Original Tone Media 1, 2, and 3.

* You can also use SN-SPLA series Cards for the D-series and sound library Cards from the U-series (SN-U110 series).

* The D-70 cannot use sound library ROM Cards for D-series models (D-5/10/20/50/110/550) (PN-D10 series or PN-D50 series).

* The D-70 cannot use the following data of the U-series sound library Cards.

- LATIN SETUP and F.X. SETUP from Card SN-U110-02 (Latin & F.X. Percussion)
- 28.N.DANCE from Card SN-U110-08 (Synthesizer)
- The Card SN-U110-10 (Rock Drums)

② Select the Original Tone Number.

Use **▲**/**▼**/**◀**/**▶** to move the cursor, and select the number.

F4 will decrease the number by 10 and switch the List.

F5 will increase the number by 10 and switch the List.

* The displayed List of Original Tone Numbers will keep within the number of Original Tones actually contained in the selected Original Tone Media.

★ About Original Tones

The sound you hear when playing an Original Tone in this display is the actual sound of the Original Tone.

*Selecting an Original Tone in the 14.Tone PRM or 19.Rhythm PRM display will select only the PCM Wave of the Original Tone, and will apply the TVF. In these displays, you are not hearing the sound of the Original Tone, but rather the sound of the Tone (⇨ P.74, 75).

Chapter 4

Write / Command

Chapter 4

1 WRITE

User Set, Performance, Patch, and Tone settings in the Temporary area are temporary. This data will be lost when you select another User Set Group or Performance etc., or turn the power off. If you wish to keep the edited data, you must Write it into Internal memory or a RAM Card. (⇨ P.78, "How memory is organized")

1. Different Types of Write Operation

The type of Write operation depends on the data that is being written.

● User Set Write

In the User Set display, press **WRITE** to write the User Set data. (This will assign Performances to a User Set group.)

● Performance Write

In the Play mode displays for MIDI OUT, MIDI CTRL Map, Reverb, Chorus, Controller Map, Part PRM 1, or Part PRM 2, or in the Performance Edit displays press **WRITE** to write the Performance data.

● Patch Write

In the Play mode displays for Tone Display or L/U PRM, or in the Patch Edit displays, press **WRITE** to write the Patch data.

● Tone Write

In the Tone Edit displays, press **WRITE** to write the Tone data.

*In the following displays, the Write operation is not possible. (Pressing **WRITE** will have no effect.)

- Tone Display R display in Play mode
- Rhythm Setup and System Setup display in Edit mode
- Orig.Tone (PCM) Play display
- ROM Play display
- The Performance, Patch, and Tone List displays
- The Jump display
- The Command display

■ Store All command

The Write command allows you to individually write each piece of data into the memory area one by one. However by executing the Store All command, you can write all data into the memory area. This command also allows you to write data between Internal and RAM Card memories. (⇨ P.158, P.164)

2. Caution When Writing Data

●The Write operation applies to the data which is displayed in the screen, not the data which is being played from the keyboard (the KB PART). For example if the KB PART is Part 1, and the Patch Edit display is showing Part 2, the Patch for Part 2 will be written into memory area. ((☞ P.95), "Editing a Part")

●When you write a Patch, the sound of each Performance which uses the newly written Patch will be affected.

●When you write a Tone, the sound of each Patch which uses the newly written Tone will be affected.

●If you have written an internal Performance to RAM Card, all Patches used by that Performance, and all Tones used by those Patches will be selected from the RAM Card memories of the same number. This means that writing a Performance into RAM Card does not necessarily guarantee that it will sound the same as the original internal Performance. To store all data for a Performance, each Patch used by that Performance, and each Tone used by those Patches must be individually written into the RAM Card. The same applies when writing a RAM Card Performance to Internal memory.

*The Store All function allows you to store all settings in a single step (☞ P.158, 164).

●If you have written an internal Patch to RAM Card, all Tones used by that Patch will be selected from the RAM Card memories of the same number. This means that writing a Patch into a RAM Card does not necessarily guarantee that it will sound the same as the original internal Patch. To store all data for a Patch, each Tone used by that Patch must be individually written into the RAM Card.

The same applies when writing a RAM Card Patch to Internal memory.

*The Store All function allows you to store all settings in a single step (☞ P.158, 164).

3. Procedures

Here's how to write Performance, Patch, and Tone data.

■ Select the Write display

When in Play mode or Edit mode, press the **WRITE** button to get the Write display. The Write display will depend on the mode when you pressed **WRITE** (⇨ P.150).

(Example) If you press **WRITE** from the Performance Edit display

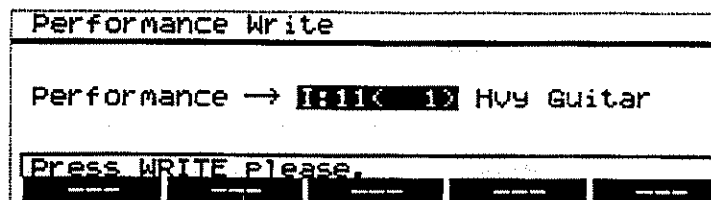

■ Select the Write destination

● When writing a Performance or Patch

The cursor will be fixed at the Number location.

Use **INT/CARD** → (**A/B**) → **BANK** → **NUMBER**, or **INC/DEC**, **VALUE** to select the Performance or Patch Number into which you wish to write the data.

* **A/B** is used when writing a Patch.

* The currently selected number will initially be displayed as the write destination.

* If you have used the Name Delete command to delete the names of unneeded data, it will be easy to find appropriate writing Destinations (⇨ P.158, 166).

● When writing a Tone

The Tone write display is as follows.

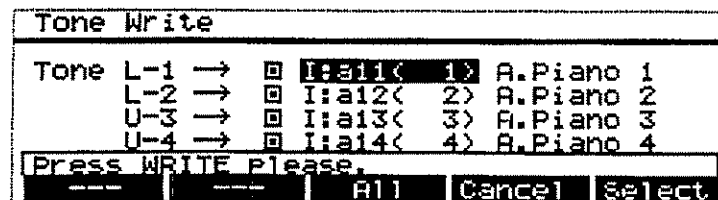

In addition to the Tone selected in the Tone Edit display, you can also write Tones from other Sections of the same Tone Palette.

To select a Tone, move the cursor to the Tone number, and press **F5** **Select**. Each time you press the button, the display will alternate between Select () and Cancel ()

* This can also be selected by changing the Tone number selected by the cursor.

To select all Tones, press **F3** **All**.

To cancel the selection of all four Tones, press **F4** **Cancel**.

Use **INT/CARD** → **A/B** → **BANK** → **NUMBER**, or **INC/DEC**, **VALUE** to select the number into which you wish to write the Tone.

* The currently selected number will initially be displayed as the write destination.

* If you have used the Name Delete command to delete the names of unneeded data, it will be easy to find appropriate writing Destinations. (→ P.158, 166)

Execute the Write operation

After specifying the writing destination, press **WRITE**. The display will ask "Are you sure? Press **ENTER** please."

If you are sure you want to write the data, press **ENTER**. To cancel without writing press **EXIT**.

If the writing destination is Internal, the rear panel Protect Switch must be Off in order for data to be written. If you attempt to execute writing with the Protect Switch On, a message of "Internal Memory Protect On! (EXIT)" will appear. Press any button to return to the write display. Turn the Protect Switch Off, and try the operation again.

If the writing destination is RAM Card, the RAM Card Protect Switch must be Off in order for data to be written. If you attempt to execute writing with the Protect Switch On, a message of "RAM Card Memory Protect On! (EXIT)" will appear. Press any button to return to the write display. Turn the Protect Switch Off, and try the operation again.

After the Write operation has been executed, you will return to the display you were in before pressing **WRITE**. After writing data, be sure to turn the Protect Switch On.

In the Tone Write operation, if you have specified the same writing Destination for two or more Tones, the display will show "Check Destination Numbers!". If you are sure you want to write the data, press **ENTER**. To cancel without writing, press **EXIT**, and re-specify the writing Destinations. (If you write two or more different data of Temporary area into a single writing Destination, all but the last-written Tone will be lost.)

4. How to Assign a Performance to a User Set

To assign a Performance to a function button (F1 — F5) in the User Set display, use the following procedure.

■ Specify the Performance to assign

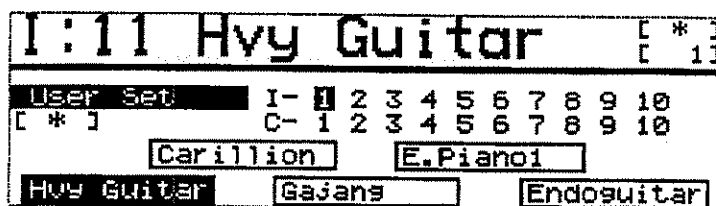

① Press **PLAY** to get the User Set display.

② Use **▲/▼/◀/▶** to select the Group of User Sets you wish to assign.

* To select a group in the internal memory, use **BANK** buttons (1 — 8), and to change groups on a RAM card, use **NUMBER** buttons (1 — 8). Group 9 or 10 cannot be selected.

* When you select the Group, the current User Set temporary area will be lost (☞ P.78).

Do not change the Group until the Write procedure is ended.

* If a RAM Card is not inserted, RAM Card Groups cannot be selected.

③ Press the function button you wish to assign.

The Performance for the function button you pressed will be displayed in inverse display.

④ Press **PERFORMANCE** (to get the Performance List display), and use **INT/CARD**, **BANK** and **NUMBER** to select the Performance you wish to assign. (Be sure to press **NUMBER** last.)

* When a RAM Card is not connected to the D - 70, Performances on the RAM Card cannot be used.

⑤ Press **EXIT** or **PLAY** to return to the User Set display.

The name of the selected Performance will be displayed for the function button you pressed.

⑥ Repeat steps ③ — ⑤ to assign a Performance to each function button.

■ Select the Write display

When you have assigned a Performance to each function button, press **WRITE** to get the User Set Write display.

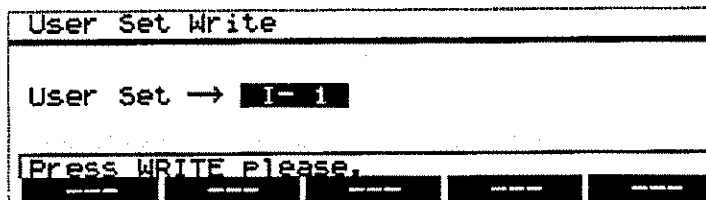

■ Select the writing destination

The cursor will be fixed at the Group.

Use **INC** / **DEC** or **VALUE** to select the Group into which you will write the User Set.

*When you write a User Set, you can choose the destination between the Internal and RAM Card.

■ Execute the Write operation

After specifying the destination, press **WRITE**. The display will ask "Are you sure? Press **ENTER** please.". If you are sure you want to write the data, press **ENTER**. To cancel without writing press **EXIT**.

If the writing destination is Internal, the rear panel Protect Switch must be Off in order for data to be written. If you attempt to execute writing with the Protect Switch On, a message of "Internal Memory Protect On! (EXIT)" will appear. Press any button to return to the write display. Turn the Protect Switch Off, and try the operation again.

If the writing destination is RAM Card, the RAM Card Protect Switch must be Off in order for data to be written. If you attempt to execute writing with the Protect Switch On, a message of "RAM Card Memory Protect On! (EXIT)" will appear. Press any button to return to the write display. Turn the Protect Switch Off, and try the operation again.

After the Write operation has been executed, you will return to the User Set display. After writing data, be sure to turn the Protect Switch On.

2 COMMAND

Various useful commands are provided, allowing you to create multiple copies of similar data, to initialize data, or edit data.

1. Types of Command

Commands can be classified depending on the data which they affect.

- **Channel Settings** In the Play Mode displays or 24. System Setup display, press **COMMAND** to edit MIDI Channel settings.
This is the same as the Performance Command CH Setting.

- **Performance Command** In the Performance Edit displays, press **COMMAND** to edit Performance data. The menu includes Copy, Initialize, Exchange, CH Setting and Store All.

- **Patch Command** In the Patch Edit displays, press **COMMAND** to edit Patch data. The menu includes Copy, Initialize, Exchange and Store All.

- **Tone Command** In the Tone Edit displays, press **COMMAND** to edit Tone data. The menu includes Copy, Initialize, Exchange, Orig.Tone PRM and Store All.

- **Name Delete** In the Performance, Patch, or Tone List displays, press **COMMAND** to delete a name.

*Commands cannot be executed in the following displays. (Pressing the **COMMAND** will have no effect.)

- In the Rhythm Setup and Data Transfer/CH Name displays of Edit mode.
- In the Orig.Tone (PCM) Play display or ROM Play display.
- The Jump display
- The Write display

2. Command Functions

Copy, Initialize, and Exchange are common to the Performance, Patch, and Tone commands.

*If Internal data has been read into the Temporary area, these commands will Copy/Exchange data in the Internal Memory area. If RAM Card data has been read into the Temporary area, these commands will Copy/Exchange data in the RAM Card Memory area.

● Copy

Copy all data from the specified memory area to the Temporary area. This Copy command is useful when you wish to create multiple data with similar settings.

(Example) When Performance Copy is executed

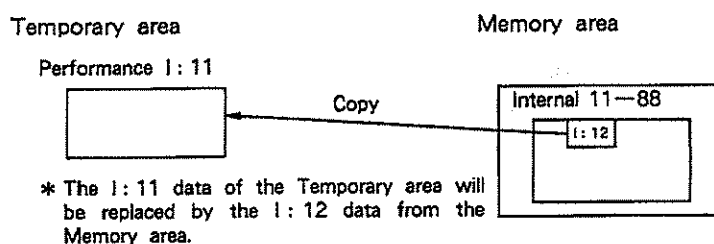

● Initialize

Initialize the data in the Temporary area.

*The page 182 shows the initialized values for each type of data.

● Exchange

Exchange the data of the Temporary area with the data of the specified Memory area. This Exchange command is useful when you wish to make sure of a Writing destination, when comparing edited and unedited data, or when rearranging data.

(Example) When Performance Exchange is executed

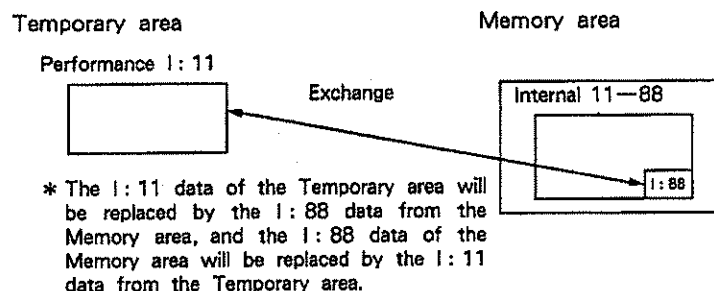

■ Special Commands

The special commands CH Setting, Orig.Tone PRM, Store All and Name Delete are provided.

● CH Setting

Play mode and Edit mode include displays in which the Channel can be edited. (Play mode: MIDI OUT, Part PRM 1. Edit mode: 2.Part Setting, 6.MIDI Palette, 24.System Setup.) However, the System Setup Control Channel cannot be set to the same number as a channel specified in one of these displays (i.e., the channel of each Part, and the channel of each MIDI Palette Section). If it is set to the same number, it will be turned off and therefore cannot be used, while the display will continue to show the Control Channel number.

To avoid problems, this display allows you to view all channels while you edit.

● Orig. Tone PRM

When you change the Original Tone in the 14.Tone PRM display, only the PCM Wave of the Original Tone will be read. If you wish to read the Name and TVA parameters of the Original Tone as well, use this command.

● Store All

When using the Write command, you must individually write each piece of data into the memory area. However this Store All command writes all data into the memory area with a single command. It is especially convenient when you have edited a large amount of data in Edit mode, and need to write all your edits into memory.

*The data in the temporary area is temporary, and will be lost if you select other data or turn the power off before writing it into the memory area.

If the temporary area contains data from Internal memory, the Write command always writes the data into Internal memory. If the temporary area contains data from RAM Card memory, the Write command always writes the data into RAM Card memory.

However this Store All command allows you to freely specify Internal or RAM Card memory, regardless of where the data in the temporary area came from.

This function is helpful when you need to write RAM Card data into the Internal memory area, etc.

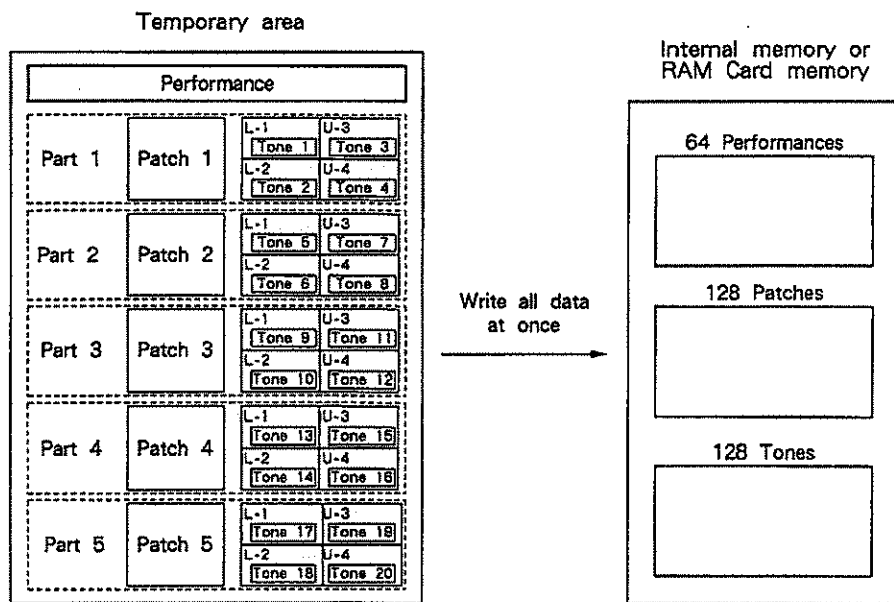

● Name Delete

This command deletes the names of unwanted Performances, Patches, or Tones in the memory area, in order to avoid confusing them with other data.

If you have used this command to delete the names of unneeded data, it will be easy to find appropriate writing Destinations for the Write or Store All commands.

*The Name Delete command does not affect the Temporary area, but directly deletes the name data in the Memory area. Data other than the name is not affected.

3. Notes When Executing a Command

- When you execute a command, the data in the temporary area or in memory will be changed, so please be sure you understand the command before executing it.
- The data affected by a command is the data which is displayed in the screen, not the data which is being played from the keyboard (the KB PART). For example if the KB PART is Part 1, and the Patch Edit display is showing Part 2, the Patch settings for Part 2 will be affected ((⇐ P.95), "Editing a Part")
- When you Exchange a Patch, the sound of each Performance which uses the newly written Patch will be affected.
- When you Exchange a Tone, the sound of each Patch which uses the newly written Tone will be affected.
- When you execute a Copy/Initialize/Exchange command, Temporary area data in lower levels may be lost (⇐ P.81).

4. Procedures

There are five different procedures used when executing a command; when executing Copy, Initialize, or Exchange, when executing CH Setting, when executing Orig.Tone PRM, when executing Store All, and when executing Name Delete.

■ To execute Copy, Initialize, or Exchange

To execute Copy, Initialize, or Exchange, use the following procedure.

● Get the Command Menu display

Press **COMMAND** to get the Command Menu. The Command Menu will depend on the currently selected display (⇐ P.156).

(Example) If you press **COMMAND** from the Performance Edit displays.

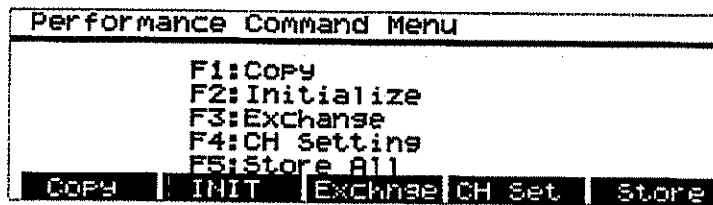

● Select a command

Use the function buttons to select the command you wish to execute; Copy, Initialize, or Exchange.

F1 → Copy, **F2** → Initialize, **F3** → Exchange

(Example) If you press **F1** **Copy** to select the Copy display.

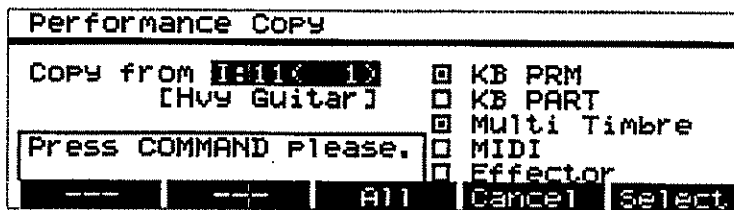

● Specify the data

Move the cursor to a number (either Performance, Patch, or Tone), and use (**A/B**) → **BANK** → **NUMBER**, or **INC** / **DEC**, **VALUE** to select the memory number which the command will affect.

* Use **A/B** for Patch or Tone commands.

* In the Initialize display, you cannot specify the data to which the command will apply. The command will always apply to the currently selected data.

● **Select parameters**

The display will show the group of parameters to which the command will affect. Commands can be executed for specific group units.

Move the cursor to the group unit and press **F5 Select**. Each time you press the button, the display will alternate between Select (■) and Cancel (□).

Press **F3 All** to select all groups.

Press **F4 Cancel** to cancel the selection of all groups.

	Group	Parameter
Performance Command	KB PRM	Parameters in the 1. KB PRM screen.
	KB PART	Parameters in the screen of the 2. Part Setting and 3. Int CTRL Map in KB PART. * When the KB PART is set to the Rhythm Part, parameters on the 3. Int CTRL Map are not relevant.
	Multi Timbre	Parameters in the screen of the 2. Part Setting and 3. Int CTRL Map in all Parts except for KB PART.
	MIDI	Parameters in the 4. MIDI CTRL Map and 5. MIDI OUT and 6. MIDI Palette screens.
	Effector	Parameters in the 7. Effector screen.
Patch Command	Patch Common	Parameters in the 8. Patch Common screen.
	Patch L/U PRM	Parameters in the 9. Patch L/U PRM screen.
	Palette Lower	Parameters in the 10. Palette L-1 and 11. Palette L-2 screens.
	Palette Upper	Parameters in the 12. Palette U-3 and 13. Palette U-4 screens.
Tone Command	Tone PRM	Parameters in the 14. Tone PRM screen
	Pitch	Parameters in the 15. Tone Pitch screen. * Parameters related with DLM are not included.
	TVF	Parameters in the 16. Tone TVF screen.
	TVA	Parameters in the 17. Tone TVA screen.
	LFO	Parameters in the 18. Tone LFO screen.

● **Execute the command**

After selecting the group to which the command will apply, press **COMMAND**. The display will ask "Are you sure? Press ENTER please." If you are sure you want to execute the command, press **ENTER**. To cancel without executing, press **EXIT**.

When using the Exchange command on Internal memory data, the rear panel Protect Switch must be Off. If you attempt to execute the Exchange command with the Protect Switch On, a message of "Internal Memory Protect On! (EXIT)" will appear. Press any button to return to the Exchange display. Turn the Protect Switch Off, and try the command again.

When using the Exchange command on RAM Card data, the RAM Card Protect Switch must be Off. If you attempt to execute the Exchange command with the Protect Switch On, a message of "RAM Card Memory Protect On! (EXIT)" will appear. Press any button to return to the Exchange display. Turn the Protect Switch Off, and try the command again.

After the command has been executed, you will return to the display you were in before pressing **COMMAND**.

*After executing the Exchange operation, be sure to return the Protect Switch to the On position.

■ To modify the CH Setting

To modify the CH Setting, use the following procedure.

● Get the Command Menu display

From the Performance Edit displays, press **COMMAND** to get the Performance Command Menu.

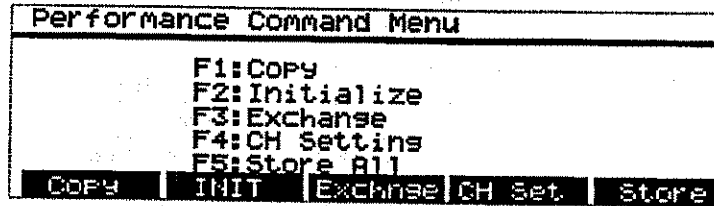

● Select the command Press **F4** **CH Set** to get the following display.

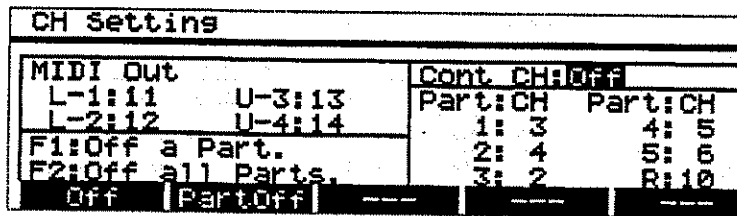

*If you press **COMMAND** in the Play Mode displays or 24. System Setup display, this screen will appear immediately.

● Make channel settings

To make channel settings, move the cursor to the parameter you wish to modify, and use **INC** / **DEC** or **VALUE** to enter the channel number.

Press **F1** **Off** to turn off the channel selected by the cursor.

Press **F2** **PartOff** to turn all parts off; Parts 1 — 5 and R (Rhythm Part).

*The MIDI OUT Section channels do not have an Off setting.

● Return to the previous display

When you have finished making channel settings, press **EXIT** to return to the previous display.

■ To execute Orig. Tone PRM

To execute Orig. Tone PRM, use the following procedure.

● Get the Command Menu display

From the Tone Edit displays, press **COMMAND** to get the Tone Command Menu.

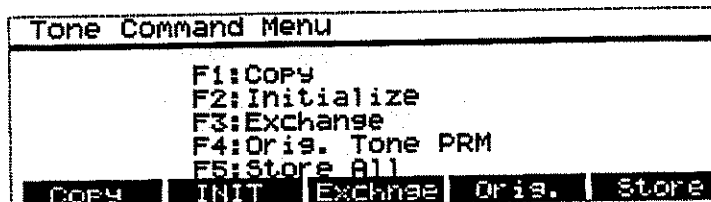

● Select the command Press **F4** **Orig.** to get the following display.

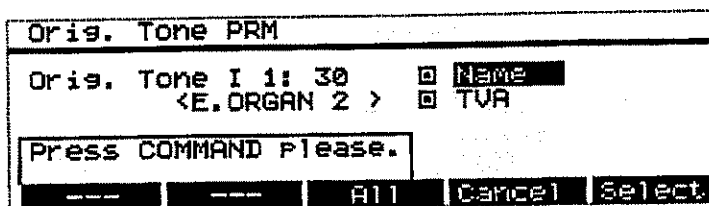

● Select parameters

The screen will display the group of Original Tone parameters to which the command will apply. The command can be executed on specific groups.

Move the cursor to the group position and press **F5** **Select**. Each time you press the button, the display will alternate between Select () and Cancel () .

Press **F3** **All** to select all Groups.

Press **F4** **Cancel** to cancel the selection of all Groups.

Name: the name of the Original Tone

TVA: TVA parameters

● Execute the command

After selecting the group for which to execute Orig. Tone PRM, press **COMMAND**. You will be asked "Are you sure? Press ENTER please.". If you are sure you want to execute the command, press **ENTER**. To cancel without executing, press **EXIT**.

After executing, you will return to the display you were in before pressing **COMMAND**.

To execute Store All

To execute Store All, use the following procedure.

● Get the Command Menu display

Press **COMMAND**, and the Command Menu will appear. The Command Menu will depend on the currently selected display (P.156).

(Example) When you press **COMMAND** from the Performance Edit displays.

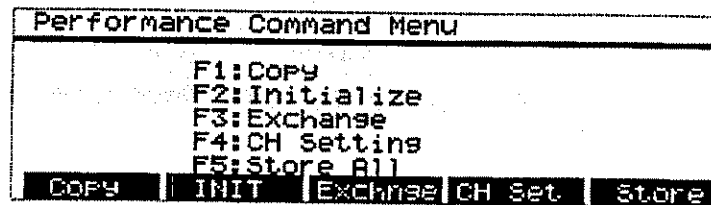

● Select the command

Press **F5** **Store** to select the display.

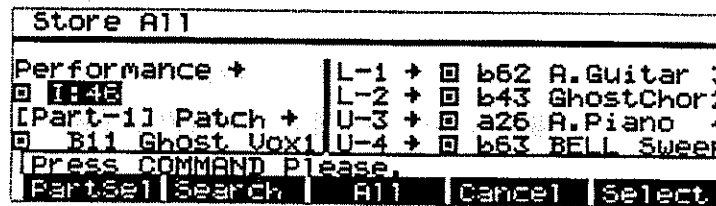

● Specify the data

You can choose to write 1 Performance, five Patches of Parts 1—5, or 20 Tones. The display will show the Performance, and the Patch and Tones of the currently selected Part. When you select a Part, the Patch and Tones will also change.

Move the cursor to the location of the data you wish to write, and press **F5** **Select**. Each time you press the button, you will alternate between select () and cancel ()

Press **F1** **PartSel** to select the Part display.

Press **F3** **All** to select all data.

Press **F4** **Cancel** to cancel all data selections.

* **F3** and **F4** can be used only for the Patch and Tones of the currently displayed Part.

● Select the write destination

If you select Internal as the writing destination, the Performance, Patches, and Tones will all be written into Internal memory. In the same way, if you select RAM Card, the data will be written into RAM Card. It is not possible to specify a combination of Internal and RAM Card destinations.

To choose between Internal and RAM Card, press **INT/CARD**. Or, you can move the cursor to the location of the Performance and use **INC** / **DEC** or **VALUE**. I (Internal) or C (RAM Card) will be displayed at the location of the Performance number.

* You can press **INT/CARD** to choose the destination even if the cursor is not located at the Performance.

To select the writing destination of the Performance, Patches, and Tones, use (**A/B**) → **BANK** → **NUMBER**, or **INC** / **DEC** and **VALUE**.

* Use **A/B** when selecting Patches and Tones.

* The currently selected number will be displayed as the writing destination.

F2 **Search** will automatically search what has been Name Deleted at destination that the cursor currently indicates.

* If you have used the Name Delete command to delete the names of unneeded data, it will be easy to find appropriate writing Destinations. (← P.158, 166)

* The "*" mark shown at the left of the number in the destination indicates that the data in the temporary area has been edited but not been written yet.

If you change the writing destination of a Patch, the Patch Select parameter in the Performance will be automatically modified and rewritten to the number of the new writing destination. In the same way, if you change the writing destination of a Tone, the Tone Select parameter in the Patch will be rewritten to the number of the writing destination. This ensures that the result will sound the same as before you executed the Write operation.

● Execute the command

When you have specified the writing destination, press **COMMAND**. The display will ask "Are you sure? Press ENTER please." If you are sure you want to execute, press **ENTER**. To quit without executing, press **EXIT**.

If the writing destination is Internal, the Protect Switch on the rear panel must be Off for this operation to be executed. If you attempt to execute the operation with the Protect Switch On, the display will show "Internal Memory Protect On! (EXIT)". Press any button, and you will return to the Store All display. Turn the Protect Switch Off, and try the operation again.

In the same way, if the writing destination is RAM Card, the Protect Switch on the RAM Card must be Off for this operation to be executed. If you attempt to execute the operation with the RAM Card Protect Switch On, the display will show "RAM Card Memory Protect On! (EXIT)". Press any button, and you will return to the Store All display. Turn the Protect Switch Off, and try the operation again.

After the Store All command has been executed, you will return to the previous display. After executing, be sure to return the Protect Switch to the On position.

If the writing Destinations of two or more Patches or Tones have been specified as the same number, the display will show "Check Destination Numbers!". If you are sure you want to write the data, press **ENTER**. To cancel without writing, press **EXIT**, and re-specify the writing Destinations. (If you write two or more different data of Temporary area into a single writing Destination, all but the last-written Patch or Tone will be lost.)

■ To execute Name Delete

To execute Name Delete, use the following procedure.

● Select the List display

Select the Performance, Patch, or Tone List display (⇨ P.44, 45, 90, 91).

● Select the data

Use (), , to select the Performance, Patch, or Tone whose name you wish to delete. (Be sure to press last.)

*Use when selecting a Patch or Tone.

● Execute the command

Press to select the display.

(Example) If you press from the Patch List display.

```

I:A11 Name Delete → .....-A11
Sure? Press ENTER Please.
-----
Patch          A Bank 1
1. A.Fiend     5. Soundtrck3
2. Fantasia   6. Hvy Guitar
3. Soundtrck1 7. PowerBrass
4. Soundtrck2 8. Marimba
    
```

The display will ask "Sure? Press ENTER please". If you are sure you want to execute, press .
To cancel without executing, press .

When you execute the Name Delete command, the data name will change as follows, and the last three digits will indicate the selected number.

```

Performance⇒ ..... 11
Patch⇒       .....A11
Tone⇒        .....a11
    
```

*This command does not affect the Temporary area, but directly deletes the name data in the Memory area. Data other than the name is not affected.

If the specified data is in Internal memory, the rear panel Protect Switch must be Off in order to execute this command. If you attempt to execute the command with the Protect Switch On, the display will show "Internal Memory Protect On! (EXIT)". Press any button to return to the Name Delete display. Turn the Protect Switch Off, and try the operation again.

In the same way, if the specified data is in RAM Card memory, the RAM Card Protect Switch must be Off in order to execute this command. If you attempt to execute the command with the Protect Switch On, the display will show "RAM Card Memory Protect On! (EXIT)". Press any button to return to the Name Delete display. Turn the Protect Switch Off, and try the operation again.

After this command is executed, you will return to the List display. After executing, be sure to return the Protect Switch to the On position.

Chapter 5

Appendix

Chapter 5

1 ERROR MESSAGES

● Internal Battery Low! (EXIT)

Cause: The D - 70's internal backup battery has run down.

Action: Contact a Roland service center. (When you press **EXIT**, you will move to the User Set display, and can continue playing.)

● RAM Card Battery Low! (EXIT)

Cause: The backup battery of the RAM Card has run down.

Action: Press **EXIT** to return to the previous display. Save the data to a different RAM Card, and replace the battery as explained in the manual for the RAM Card.

● No RAM Card! (EXIT)

Cause: When you selected RAM Card, a RAM Card was not inserted into the RAM Card slot or was not correctly inserted.

Action: Correctly insert the RAM Card into the RAM Card slot. (Press **EXIT** to return to the previous display.)

● Improper RAM Card! (EXIT)

Cause: The card inserted into the RAM Card slot is not in D - 70 format, or is a PCM Card.

Action: Press **EXIT** to return to the previous display. In order to use a new RAM Card, or a RAM Card which has been used by devices other than the D - 70, you must execute the Format operation in the 25.D.Xer I ↔ C display. The RAM Card will be formatted, and the contents of the D - 70's internal memory will be automatically written into the card. Please use M - 256E RAM Cards.

Action: If you have inserted the card by mistake, remove it immediately. (Press **EXIT** to return to the previous display.)

● Internal Memory Protect On! (EXIT)

Cause: Since the internal Protect switch is On, operations such as Write, Command, or Data Transfer cannot be executed.

Action: Press **EXIT** to return to the previous display (Write, Command, or Data Transfer), turn the rear panel Protect switch Off, and try the operation again.

● RAM Card Memory Protect On! (EXIT)

Cause: Since the RAM Card Protect switch is On, operations such as Write, Command, or Data Transfer cannot be executed.

Action: Press **EXIT** to return to the previous display (Write, Command, or Data Transfer), turn the RAM Card Protect switch Off, and try the operation again.

● Are you sure? Press ENTER please.

Cause: This display will appear when you execute Write, Command, Data Transfer, etc.

Action: To execute the operation, press **ENTER**. To quit without executing, press **EXIT**.

● Complete

Cause: Processing has been completed for Write, Command, Data Transfer, etc.

Action: Wait a short time, and the previous display will reappear.

● Check Destination Numbers! (EXIT)

Cause: This display will appear when the same writing destination has been specified for two or more Patches or Tones in the Tone Write operation or the Store All operation.

Action: To write the data, press **ENTER**. To cancel without writing, press **EXIT** to return to the the Tone Write display or the Store All display, and specify a different writing destination for each Patch or Tone.

● Transmitting Exclusive

Cause: Exclusive messages are being transmitted. If the exclusive message is short, this display will not appear.

Action: Wait for the "Complete" display, and then for the previous display to reappear.

● Receiving Exclusive

Cause: Exclusive messages are being received. If the exclusive message is short, this display will not appear.

Action: Please wait.

● Exclusive Data Error! (EXIT)

Cause: Due to an incorrect checksum, data length, or exclusive format, exclusive data was not correctly received.

Action: Press **EXIT** to return to the previous display. Check MIDI cables and the data being transmitted, and try the operation again.

● Exclusive Communication Error! (EXIT)

Cause: This message will appear during a data transfer if the data was not correctly transferred (for example during a Handshake Dump when the receiving device was producing a note and refused communication).

Action: Press **EXIT** to return to the previous display. Check connections and the status of the other device, and try the operation again.

● Handshake Mode Timeout Occurred! (EXIT)

Cause: This will be displayed if the other device stops responding during a Handshake Dump.

Action: Press **EXIT** to return to the previous display. Check connections and Unit Numbers, and try the operation again.

● MIDI Buffer Full! (EXIT)

Cause: The D-70 received more MIDI data than it was able to handle at once.

Action: Press **EXIT** to return to the previous display. Check whether or not a large amount of data which requires processing on reception (program changes, etc.) is being transmitted continuously.

● Too much note event (EXIT)

Cause: The D-70 received excessive note events.

Action: Press the **EXIT** to return to previous display. Check if too excessive keys have been simultaneously pressed and if excessive note events are being received through the MIDI IN socket.

2 TROUBLESHOOTING

■ No sound

- Is the power turned on for the D - 70, amp, mixer, etc.?
- Have connections been made correctly?
- Have you confused the Mix Outs and Direct Outs? Check the Output Assign settings. (☞ P.53, 112, 131)
- Are the connecting cables ok?
- Are the volumes turned down for the amp, mixer, or external MIDI sound source?
- Is the D - 70's volume turned down?

[Internal sound source]

- Check the position of the Master Volume slider.
- Check the Output Level specified in each Part. (☞ P.86, 98)
- Check the Patch Level specified in each Patch. (☞ P.53, 107)
- Check the Level specified in each Section of the Tone Palette. (☞ P.109)
- Check the Level specified in the TVA of the Tone. (☞ P.124)
- Check the Level specified for each key in the TVA of the Rhythm Tone. (☞ P.134)
- If the Level function is assigned to Tone Palette Sliders, check the slider position. (☞ P.54)
- If the TVA function is assigned to C1/Exp Pedal, check the slider or pedal position.

[MIDI OUT]

- Check the MIDI Volume specified in each Section of the MIDI Palette. (☞ P.104)
- If the MIDI Volume function is assigned to Tone Palette Sliders, check the slider position. (☞ P.69)
- If the C.Chg 7/Volume function is assigned to C1/Exp Pedal, check the slider or pedal position
- Have the Output Levels of the Parts been lowered by Volume messages received from MIDI IN?
- Is the System Setup parameter Local SW turned Off? (☞ P.139)
- Is the KB PART turned Off? (☞ P.67, 96)
- Is muting active?

- Muting of each Section of the Tone Palette (☞ P.43, 113)
- Muting of each Section of the MIDI Palette (☞ P.44, 104)

- Are the Zone ranges set correctly?

- How is the Zone of the Part related to the Key Mode? (☞ P.54, 57, 86, 98, 108)
- If the Key Mode is Zone, check the Zone specified for each Section of the Tone Palette. (☞ P.43, 113)
- If the Key Mode is Zone, check the Zone specified for each Section of the MIDI Palette. (☞ P.44, 104)

- Are the MIDI channels correct?

- Check the channel of each Part. (☞ P.68, 98)
- Check the channel of each Section of the MIDI Palette. (☞ P.68, 104)
- Check the MIDI channels before and after selecting a Performance.

- Is the PCM Card specified by Original Tone Media inserted correctly? (☞ P.114, 129)

- It is not possible to produce sound outside of the pitch range of the Original Tone. Refer to the included Sound Chart.

- Have the Patch parameter Key Shift or the Tone parameter Pitch Coarse, or the Rhythm Tone parameters Source Key or Pitch Coarse been set so that the pitch falls outside of the pitch range of the Original Tone? (☞ P.111, 116, 130, 132)

- Is the Cutoff setting lowered? If the filter is Low Pass or Band Pass, and the Patch parameter Cutoff, the Tone parameter Cutoff, and the ENV Depth are set to " - " (negative), and the Cutoff is lowered, there may be no sound. (☞ P.112, 119, 121)

- Check the DLM settings. Some DLM settings may result in no sound. (☞ P.115)

- Can you hear sound through the headphones? If you can, the problem may be in the connected devices or connection cables.

- The D - 70 will not sound while exclusive messages are being received and the data is being changed.

- The D - 70 will not sound while Performances or Patches are being changed.

- When the Panic function is used, there will be no sound for approximately four seconds.

- Is the D - 70 in ROM Play mode? In ROM Play mode, the D - 70 cannot be played by the keyboard or by messages received at MIDI IN.

■ Can't control the volume

- Only the Mix Out output jacks are affected by the Master Volume slider. To control the output of the Direct Out jacks, adjust the connected amp or mixer.
- Is the Volume Rx parameter for each Part turned Off? (☞ P.67, 99)

■ Pitch is wrong / does not change

- Is the Master Tuning setting correct? (☞ P.137)
- If the pitch range of the Original Tone has been exceeded, there will be no sound regardless of the Controller or Key Shift settings. Refer to the included Sound Chart for the pitch ranges of the Original Tones.
- Check the Values and Destinations assigned to the Pitch function in the Controller Map for Bender or C1/Exp Pedal, etc. (☞ P.64, 71, 96, 99, 101)
- Check the Key Shift and Fine Tune settings for each section of the Tone Palette. (☞ P.54, 111)
- Check the Pitch Coarse and Pitch Fine settings for a Tone or Rhythm Tone. (☞ P.116, 132)
- Check the Pitch Key Follow setting of the Tone. (☞ P.116)
- If the pitch is wrong for only a specific Patch or Tone, the reason is in the settings of that Patch or Tone.
- Is the Tuning of an external MIDI sound source correct?
- Check the Transpose settings for each Section of the MIDI Palette. (☞ P.69, 104)
- Is the Pitch Bender turned Off on an external MIDI sound source?
- Are the MIDI OUT Controller Map settings correct? (☞ P.71, 101)
- Is an external MIDI sound source being Key Shifted?
- Has a "non-zero" Pitch Bend message been received without returning to zero? Press **PANIC** or reselect the Performance.
- Check the Analog Feel settings for each Part. (☞ P.67, 99)

■ Controllers don't work

[Internal sound source]

- The controllers which can be used will depend on whether the KB PART is set to a Synthe Part, the Rhythm Part, or Off.
- If the KB PART is a Synthe Part, all controllers can be used.
- If the KB PART is the Rhythm Part, the Brightness slider and the Tone Palette sliders (controlling the Output Level of the Rhythm Part) can be used.
- If the KB PART is Off, no controllers can be used.
- In the case of the Pedal SW, check that the System Setup parameter Pedal SW is set to Controller Map. If this parameter is set to other than Controller Map, the Controller Map settings will not be used. (☞ P.138)

- Check the Controller Map settings for KB PRM and each Part. (☞ P.64, 96, 99)
- Depending on the sound data, controllers may have no effect. Check the parameters of the sound data.

[External sound source]

- Is the external MIDI sound source able to respond to that type of Controller message?
- Has the external MIDI sound source reception been turned Off for that function?
- In the case of the Pedal SW, check that the System Setup parameter Pedal SW is set to Controller Map. If this parameter is set to other than Controller Map, the Controller Map settings will not be used. (☞ P.138)
- Check the Controller Map of MIDI OUT. (☞ P.71, 101)
- When using the Tone Palette sliders as controllers, the sliders can be used only when you are in the Play mode MIDI OUT and MIDI CTRL Map displays. (☞ P.39)

* Controllers other than the Tone Palette sliders can be set independently for the internal sound source (the Control Map of each Part, etc.) and for external MIDI sound sources (the MIDI OUT Control Map), meaning that a single controller can simultaneously control different things.

■ Keyboard playing dynamics are not as expected

- Check the Velocity Curve and Velocity Sensitivity settings of the Patch. (☞ P.107)
- Check the Velocity Curve, Velocity Sensitivity, Envelope etc. (TVA) settings of the Tone or Rhythm Tone. (☞ P.124, 135)
- Check the Velocity Curve and Velocity Sensitivity of MIDI OUT. (☞ P.102, 103)
- Can the external MIDI sound source respond to velocity?

■ Cannot select sounds/ cannot output program changes

[When selecting D - 70 sounds]

- Press **PERFORMANCE** to select a Performance, or press **PATCH** to select a Patch.
To select a Tone, hold **TONE/ZONE SELECT** and press **TONE**. (☞ P.44, 45, 90, 91)
- Is the channel on which to receive Program Change messages set correctly?
Program Change messages (65 — 128 will be ignored without RAM Card) received on the Control channel will select Performances. Program Change messages received on the channel of each Part will select Patches. (☞ P.49)
- Is the Program Change Rx parameter for each Part turned Off? (☞ P.67, 99)
- If you want to use the Pedal SW to select Performances, make sure that the System Setup parameter Pedal SW is set to Performance Up/Down. (☞ P.138).
- In Play mode when the KB PART is Rhythm, panel buttons will not select Patches or Tones.
- It is not possible to select sounds in the ROM Play or Orig.Tone (PCM) Play displays.

[When selecting sounds of an external sound source]

- Is Program Change reception turned Off for the external MIDI sound source?
- Do the channels of each Section of the MIDI Palette match the channels of the external MIDI sound source? (☞ P.68, 104)
- Is MIDI turned off (Muted) for each section of the MIDI Palette? If so, no MIDI messages will be transmitted. (☞ P.44, 104)
- Are Program Change messages being correctly transmitted in realtime? For details refer to P.46.
- Do the Program Change numbers being transmitted match the sound memory numbers of the external MIDI sound source?

■ Notes are interrupted or do not sound

- The D - 70 can produce up to 30 notes at once, including notes in their release stage. It is not possible to play more notes than this.
- Check the Key Mode settings of the Patch. In the case of Layer, four Tones will sound at once, and this will affect the maximum number of simultaneous notes. (☞ P.54, 57, 108)
- Check the Velocity Mode of the Upper and Lower sections of the Patch. In the case of Normal or Mix, two Tones will sound at once, and this will affect the maximum number of simultaneous notes. (☞ P.56, 108)
- Check the Priority settings. Turn Priority On for the most important Parts. (☞ P.67, 98)
- If the Lower or Upper section of the Patch is set to Solo, only single notes will be played even if chords are received from a sequencer. (☞ P.53, 56, 109)

■ No effect is applied

- Check the Effect settings of each Part. Make sure Effect is turned On. (☞ P.67, 99)
- Check the Output Assign settings of each Section. Set the Output Assign parameter to Reverb or Chorus. (☞ P.53, 112)
- Check the Reverb or Chorus levels. If the Level is 0, there will be no effect. (☞ P.59, 61, 105, 106)
- Is the System Setup parameter Pedal SW set to Effector? If so, the effector will be applied to each Part whose Effect parameter is On only while the pedal is On. (☞ P.138)

■ Stuck notes on the D - 70 or external MIDI sound source

- Press the **PANIC** button.
- Reselect the Performance.
- Check the MIDI cable connections.

■ Portamento does not work

- In order to use Portamento, the following conditions must be true.
 - the Key Assign of Lower or Upper is set to Solo
 - the Portamento of Lower or Upper is set to On
 - the Portamento Time of Lower or Upper is set above 0

Two types of Portamento are available. For details refer to P.57, 110.

■ Tone editing does not function as expected

- Is the Part or Section you wish to edit selected correctly? During editing, the keyboard will play the KB PART, not the Part selected for editing. Editing will affect the Section selected in the display. (☞ P.95)
- In the Tone Edit displays, the sound is determined by the settings for the Patch parameters (Key Mode, Cutoff, Resonance, etc.), and the Brightness slider and controllers. Check the Patch parameters. (☞ P.107)

- Check the settings of the Tone for each Section of the Patch. If these are muted, there will be no sound. During Tone editing, mute unneeded Tones. (☞ P.89, 113)

■ Cannot use a card

- The D - 70 can use the following cards.
 - RAM Cards formatted by the D - 70 (M - 256E) (☞ P.140)
 - D - series SN - SPLA PCM Cards
 - PCM Cards (SN - U110) of the U - series sound library (some cards cannot be used) (☞ P.93)
- * RAM Cards formatted by D - series instruments other than the D - 70 cannot be used.
- * D - series sound library cards (PN - D10 series and PN - D50 series) cannot be used.

■ Cannot set MIDI channels correctly

- It is possible to make MIDI channel settings in the Play and Edit displays, but there is also a command display (CH Setting) that allows you to edit while viewing all channels. (☞ P.157, 162)

■ MIDI OUT setting do not change

- If MIDI OUT settings do not change when you select a Performance, check whether the System Setup parameter MIDI OUT Link Mode is turned Off. When this parameter is On, MIDI OUT settings will change when a Performance is selected. (☞ P.138)

■ Cannot transmit data via exclusive messages

- Do the Unit Numbers of the two devices match? (☞ P.137)
- Has the type of data to be transmitted been selected correctly? If data has not been selected correctly, nothing will be transmitted. (☞ P.139, 142)

3 PARAMETER LIST

System Setup

	Parameter	Display	Value
	Master Tune	M. Tune	- 64 -- + 63
	Control Channel	Control CH	1 - 16, Off
	Exclusive Receive SW	Exclusive Rx	On, Off
	Unit Number	Unit Number	1 - 32
	Hold Pedal	Hold Pedal	Hold, Sostenuto
	Pedal SW	Pedal SW	Perform ↑, Perform ↓, Effector, Cont Map
	MIDI OUT Link Mode	MIDI Link	On, Off
	Local SW	Local SW	On, Off
Channel 1 - 16	Transmit Channel Name (10 characters)	Tx CH Name	(space) A - Z a - z 0 - 9 - / + * # . , !

User Set

Function	Parameter	Display	Value
[F1] - [F5]	Performance Number	Performance Name	I: 11 - I: 88 / C: 11 - C: 88

Performance

● KB PRM

	Parameter	Display	Value
	Performance Name (10 characters)	Name	(space) A - Z a - z 0 - 9 - / + * # . , !
	Keyboard Part	KB PART	1-5, R, Off
Controller Map			
Controller	Parameter	Display	Value
C1/Exp Pedal [Control Change Number 6 Data Entry]	Function	Function	Pitch Bend, TVF Cutoff, TVA Level, LFO Pitch, LFO TVF, LFO TVA, Portamento Time
	Value	Value	0-127 - 12 semi -- + 12 semi
	Destination	Destination	Lower, Upper, Both, Off
	Function	Function	Pitch Bend, TVF Cutoff, TVA Level, LFO Pitch, LFO TVF, LFO TVA, Portamento Time
	Value	Value	0-127 - 12 semi -- + 12 semi
	Destination	Destination	Lower, Upper, Both, Off
Pedal SW [Control Change Number 80 General Purpose Controller - 5]	Function	Function	LFO Pitch, LFO TVF, LFO TVA, Octave Up, Octave Down
	Destination	Destination	Lower, Upper, Both, Off
	Function	Function	LFO Pitch, LFO TVF, LFO TVA, Octave Up, Octave Down
	Destination	Destination	Lower, Upper, Both, Off

● Part

Part	Parameters	Display	Value		
1 - 5	Receive Channel	CH/Rx CH	1 - 16, Off		
	Patch Select	Patch Number and Name	A11 - A88, B11 - B88		
	Output Level	Level/Output Level	0 - 127		
	Zone	Zone	C - 1 - G9		
			C - 1 - G9		
	Priority	Prior/Priority	On, Off		
	Effect	Effect	On, Off		
	Analog Feel	A. Feel/Analog Feel	0 - 127		
	Program Change Receive SW	PG #/P. Change Rx	On, Off		
Volume Receive SW	Vol./Volume Rx	On, Off			
R	Receive Channel	CH/Rx CH	1 - 16, Off		
	Output Level	Level/Output Level	0 - 127		
	Zone	Zone	C - 1 - G9		
			C - 1 - G9		
	Priority	Prior/Priority	On, Off		
	Effect	Effect	On, Off		
Volume Receive SW	Vol./Volume Rx	On, Off			
Controller Map					
Controller	Parameters	Display	Value		
Part 1 - 5	Bender	Function	Function	Pitch Bend	
		Value	Value	- 48 semi - 0 semi	
		Destination	Destination	0 semi - + 12 semi	
	[Bender]	Function	Function	Lower, Upper, Both, Off	
		Value	Value	TVF Cutoff, TVA Level, LFO Pitch, LFO TVF, LFO TVA	
		Destination	Destination	0 - 127	
	A. Touch	[CAf]	Function	Function	Lower, Upper, Both, Off
			Value	Value	Pitch Bend, TVF Cutoff, TVA Level, LFO Pitch, LFO TVF, LFO TVA
			Destination	Destination	0 - 127
		[CAf]	Function	Function	- 12 semi - + 12 semi
			Value	Value	Lower, Upper, Both, Off
			Destination	Destination	Pitch Bend, TVF Cutoff, TVA Level, LFO Pitch, LFO TVF, LFO TVA
			0 - 127		
			- 12 semi - + 12 semi		
			Lower, Upper, Both, Off		

③ PARAMETER LIST

Controller Map				
Controller	Parameter	Display	Value	
Part 1 — 5	Modulation [Mod]	Function	Function	Pitch Bend, TVF Cutoff, TVA Level, LFO Pitch, LFO TVF, LFO TVA
		Value	Value	0 — 127 - 12semi — + 12semi
		Destination	Destination	Lower, Upper, Both, Off
		Function	Function	Pitch Bend, TVF Cutoff, TVA Level, LFO Pitch, LFO TVF, LFO TVA
		Value	Value	0 — 127 - 12semi — + 12semi
		Destination	Destination	Lower, Upper, Both, Off
	Hold Pedal [Hold]	Destination	Destination	Lower, Upper, Both, Off

● Effector

	Parameter	Display	Value
Reverb	Reverb/Delay Type	Type	Room 1 — 3, Hall 1, 2, Gate, Delay, Cross Delay
	Reverb/Delay Time	Time	0 — 31
	Reverb/Dely Level	Level	0 — 31
	Feedback	Feedback	0 — 31
Chorus	Chorus/Flanger Type	Type	Chorus 1, 2, FB — Chorus, Flanger, Short Delay
	Output Mode	Out Mode	Pre Reverb, Post Reverb
	Chorus/Flanger Level	Level	0 — 31
	Delay Time	Delay Time/Delay	0 — 31
	Chorus/Flanger Rate	Rate	0 — 31
	Chorus/Flanger Depth	Depth	0 — 31
	Feedback	Feedback	- 31 — + 31

● MIDI OUT

	Parameter	Display	Value
	Velocity Curve	Velo Curve	1 — 4
	Velocity Sensitivity	Velo Sens	0 — 127
	Key Mode	Key Mode	Layer, Split, Zone
	Split Point	Split Point	C — 1 — G9
Lower/Upper	Velocity Mode	Vel/Velo Mode	Normal, SW, Mix
	Threshold Sensitivity	Thr/Threshold	0 — 127
MIDI Palette			
Section	Parameter	Display	Value
L-1 — U-4	Transmit Channel	CH	1 — 16
	MIDI Volume	Volume/Vol	0 — 127
	Program Change Number	PG #	1 (a11) — 64 (a88), 65 (b11) — 128 (b88)
	Transpose	Xpose	- 24 semi — + 24 semi
	Zone	Zone	C — 1 — G9
			C — 1 — G9
MIDI	MIDI	On, Off	
Controller Map			
Controller	Parameter	Display	Value
Bender	Function	Function	Bender
	Destination	Destination	Lower, Upper, Both, Off
	Function	Function	C. Chg 0 — 95, After Touch
	Destination	Destination	Lower, Upper, Both, Off
A. Touch	Function	Function	C. Chg 0 — 95, Bender Up, Bender Down, After Touch
	Destination	Destination	Lower, Upper, Both, Off
	Function	Function	C. Chg 0 — 95, Bender Up, Bender Down, After Touch
	Destination	Destination	Lower, Upper, Both, Off
Modulation	Function	Function	C. Chg 0 — 95, Bender Up, Bender Down, After Touch
	Destination	Destination	Lower, Upper, Both, Off
	Function	Function	C. Chg 0 — 95, Bender Up, Bender Down, After Touch
	Destination	Destination	Lower, Upper, Both, Off
C1/Exp Pedal	Function	Function	C. Chg 0 — 95, Bender Up, Bender Down, After Touch
	Destination	Destination	Lower, Upper, Both, Off
	Function	Function	C. Chg 0 — 95, Bender Up, Bender Down, After Touch
	Destination	Destination	Lower, Upper, Both, Off
Pedal SW	Function	Function	C. Chg 0 — 95
	Destination	Destination	Lower, Upper, Both, Off
	Function	Function	C. Chg 0 — 95
	Destination	Destination	Lower, Upper, Both, Off
Hold Pedal	Destination	Destination	Lower, Upper, Both, Off

■ Patch

	Parameter	Display	Value	
Common	Patch Name (10 characters)	Name	(space) A — Z a — z 0 — 9 - / + * # . , !	
	Patch Level	Patch Level	0 — 127	
	Velocity Curve	Velocity Curve	1 — 4	
	Velocity Sensitivity	Velocity Sens	0 — 127	
	Key Mode	Key Mode	Layer, Split, Zone	
	Split Point	Split Point	C — 1 — G9	
Lower/Upper	Velocity Mode	Velo Mode	Normal, SW, Mix	
	Threshold Sensitivity	Threshold	0 — 127	
	Key Assign	K. Assgn/Key Assign	Poly, Solo	
	Solo Legato	Solo Legato	On, Off	
	Portamento	Porta	On, Off	
	Portamento Mode	P. Mode	Auto, Normal	
	Portamento Time	P. Time	0 — 127	
	Portamento Receive SW	PortRx	On, Off	
Pan Receive SW	Pan Rx	On, Off		
Tone Palette				
Section	Parameter	Display	Value	
L-1 — U-4	Tone Select	Tone Number and Name	a11 — a88, b11 — b88	
	Level	Level	0 — 127	
	Key Shift	K. Shift	- 24 semi — + 24 semi	
	Fine Tune	F. Tune	- 64 — + 63	
	Cutoff	Cutoff	- 64 — + 63	
	Resonance	Reso	- 64 — + 63	
	Attack Time	Attack	- 64 — + 63	
	Release Time	Release	- 64 — + 63	
	Output Assign	Output/Out	Reverb, Chorus, Dry, Direct	
	Pan	Pan	7 > — < — < 7	
	Tone	Tone	On, Off	
	Zone			C — 1 — G9
				C — 1 — G9

■ Tone

	Parameter	Display	Value
Tone PRM	Tone Name (10 characters)	Tone Name	(space) A - Z a - z 0 - 9 - / + * # . , !
	Original Tone Media	Orig. Media	1 - 3, D 1 - 32, U 1 - 32
	Original Tone Number	Orig. Number	1 - 128
	DLM	DLM	On, Off
	Mode	Mode	A, B
	Start	Start	0 - 127
	Length	Length	1 - 128
Pitch	Pitch Coarse	P. Coarse	- 48 semi - + 48 semi
	Pitch Fine	P. Fine	- 64 - + 63
	Pitch Key Follow	P. KF	(- 100, - 50, - 20, - 10, - 5, 0, + 5, + 10, + 20, + 50, + 98, + 99, + 100, + 101, + 102, + 200) %
	ENV Time Key Follow	ENV KF	(- 100, - 50, 0, + 10, + 20, + 30, + 40, + 50, + 60, + 70, + 80, + 90, + 100, + 110, + 130, + 150) %
	Attack Time	A. Tim	0 - 127
	Attack Depth	A. Depth	(- 48, - 42, - 36, - 30, - 24, - 18, - 12 - - 1, - 0.5, - 0.25, 0, + 0.25, + 0.5, + 1 - + 12) semi
	Release Time	R. Tim	0 - 127
Release Depth	R. Depth	(- 48, - 42, - 36, - 30, - 24, - 18, - 12 - - 1, - 0.5, - 0.25, 0, + 0.25, + 0.5, + 1 - + 12) semi	
TVF	Filter Mode	Filter	LPF, HPF, BPF, Bypass
	Cutoff	Cutoff	0 - 127
	Resonance	Reso	0 - 127
	Velocity Curve	V. Curve	1 - 4
	Cutoff Key Follow	KF	(- 100, - 75, - 50, - 25, 0, + 10, + 20, + 30, + 40, + 50, + 60, + 70, + 80, + 90, + 100, + 110) %
	Envelope Depth	ENV Depth	- 64 - + 63
	ENV Depth Velocity Sensitivity	ENV Depth Velo	0 - 127
	ENV Time Key Follow	TIME KF	(- 100, - 50, 0, + 10, + 20, + 30, + 40, + 50, + 60, + 70, + 80, + 90, + 100, + 110, + 130, + 150)
	ENV Tone Velocity Sensitivity	TIME Velo	0 - 127
ENV Time Release Velocity Sensitivity	TIME R. Velo	0 - 127	

PARAMETER LIST

	Parameter	Display	Value
TVF	Attack Time	A, Tim	0 - 127
	Attack Level	A, Lvl	0 - 127
	Decay 1 Time	D/B, Tim	0 - 127
	Decay Brake Point	D/B, Lvl	0 - 127
	Decay 2 Time	D/S, Tim	0 - 127
	Sustain Level	D/S, Lvl	0 - 127
	Release Time	R, Tim	0 - 127
TVA	Level	Level	0 - 127
	Velocity Curve	V, Curve	1 - 4
	Velocity Sensitivity	V, Sens	0 - 127
	ENV Time Key Follow	TIME KF	(- 100, - 50, 0, + 10, + 20, + 30, + 40, + 50, + 60, + 70, + 80, + 90, + 100, + 110, + 130, + 150) %
	ENV Time Velocity Sensitivity	TIME Velo	0 - 127
	ENV Time Release Velocity Sensitivity	TIME R. Velo	0 - 127
	Attack Time	A, Tim	0 - 127
	Attack Level	A, Lvl	0 - 127
	Decay 1 Time	D/B, Tim	0 - 127
	Decay Brake Point	D/B, Lvl	0 - 127
	Decay 2 Time	D/S, Tim	0 - 127
	Sustain Level	D/S, Lvl	0 - 127
	Release Time	R, Tim	0 - 127
LFO	Waveform	Waveform	Triangle, Sine, Square, Saw, Random
	Rate	Rate	0 - 127
	Delay Time	Delay Time	0 - 15
	Rise Time	Rise Time	0 - 15
	Offset	Offset	(- 100, - 50, 0, + 50, + 100) %
	Pitch Modulation Depth	Pitch Mod Depth	- 64 - + 63
	TVF Modulation depth	TVF Mod Depth	- 64 - + 63
	TVA Modulation Depth	TVA Mod Depth	- 64 - + 63

■ Rhythm Setup

		Parameter	Display	Value
Rhythm Common		Rhythm Shift	Rhythm Shift	- 28 semi — + 24 semi
Key : E1 — G7	Rhythm PRM	Original Tone Media	Orig. Media	I 1 — 3, D 1 — 32, U 1 — 32
		Original Tone Number	Orig. Number	1 — 128
		Source Key	Source Key	Off, C# — 1 — G9
		Mute	Mute	E1 — G7, Off
		Output Assign	Out	Reverb, Chorus, Dry, Direct
		Pan	Pan	7 > — > < — < 7
		ENV Mode	ENV	Sus, No Sus
	Pitch	Pitch Coarse	P. Coarse	- 12 semi — + 12 semi
		Pitch Fine	P. Fine	- 64 — + 63
		Attack Time	A, Tim	0 — 127
		Attack Depth	A, Depth	(- 48, - 42, - 36, - 30, - 24, - 18, - 12 — - 1, - 0.5, - 0.25, 0, + 0.25, + 0.5, + 1 — + 12) semi
	TVF	Filter Mode	Filter	LPF, HPF, BPF, Bypass
		Cutoff	Cutoff	0 — 127
		Resonance	Reso	0 — 127
		Velocity Curve	V. Curve	1 — 4
		Envelope Depth	ENV Depth	- 64 — + 63
		ENV Depth	ENV Depth Velo	0 — 127
		Velocity Sensitivity		
		Attack Time	A, Tim	0 — 127
		Attack Level	A, Lvl	0 — 127
		Decay 1 Time	D/B, Tim	0 — 127
		Decay Brake Point	D/B, Lvl	0 — 127
		Decay 2 Time	D/S, Tim	0 — 127
		Sustain Level	D/S, Lvl	0 — 127
		Release Time	R, Tim	0 — 127
	TVA	Level	Level	0 — 127
		Velocity Curve	V. Curve	1 — 4
Velocity Sensitivity		V. Sens	0 — 127	
Attack Time		A, Tim	0 — 127	
Attack Level		A, Lvl	0 — 127	
Decay 1 Time		D/B, Tim	0 — 127	
Decay Brake Point		D/B, Lvl	0 — 127	
Decay 2 Time		D/S, Tim	0 — 127	
Sustain Level		D/S, Lvl	0 — 127	
Release Time		R, Tim	0 — 127	

4 INITIALIZE DATA

Performance

Group	Screen	Parameter			
KB PRM	1. KB PRM	Name		Space	
		KB PART		1	
		Pedal			
		Function	Value	Destination	
		TVF Cutoff	0	Both	
		TVA Level	0	Both	
		Pedal SW			
		Function	Value	Destination	
		Octave Up		Upper	
		Octave Down		Lower	
KB PART or Multi Timbre	2. Part setting	Part 1-5	Rx CH	1 (Part 2-5 : Off)	
			Pach Select	A11 (1)	
			Output Level	127	
			Zone	C - 1-G9	
			Priority	Off	
			Effect	On	
			Analog Feel	0	
			P. Change Rx	On	
			Volume Rx	On	
			Part R	Rx CH	10
	Output Level	127			
	Zone	C - 1-G9			
	Priority	Off			
	Effect	On			
	Volume Rx	On			
	3. Int CTRL Map	Part 1-5	Bender		
			Function	Value	Destination
			Pitch Bend	- 2 + 2	Both
			TVF Cutoff	0	Both
			A-Touch		
Function			Value	Destination	
TVF Cutoff			0	Both	
TVA Level			0	Both	
Modulation					
Function			Value	Destination	
LFO Pitch			70	Both	
LFO TVF			0	Both	
Hold Pedal					
Function			Value	Destination	
		Both			

Group	Screen	Parameter			
MIDI	4. MIDI CTRL Map	Bender			
		Function	Destination		
		Bender	Both		
		C. Chg 16/Gen - 1	Off		
		After Touch			
		Function	Destination		
		After Touch	Both		
		C. Chg 16/Gen - 1	Off		
		Modulation			
		Function	Destination		
		C. Chg 1/Mod	Both		
		C. Chg 16/Gen - 1	Off		
		C1/Exp. Pedal			
		Function	Destination		
		C. Chg 7/Volume	Both		
	C. Chg 16/Gen - 1	Off			
	Pedal SW				
	Function	Destination			
	C. Chg 16/Gen - 1	Off			
	C. Chg 17/Gen - 2	Off			
Hold Pedal					
Function	Destination				
	Both				
5. MIDI OUT	Velo Curve	1			
	Velo Sens	127			
	Key Mode	Layer			
	Split Point	A4			
	Velo Mode	Normal			
	Threshold	80			
6. MIDI Palette	CH	1 (L-2-U-4: 2, 3, 4)			
	Volume	127			
	PG #	1 (a11)			
	Xpose	0			
	Zone	C-1-G9			
	MIDI	On (L-2-U-4: Off)			
Effector	7. Effector	Reverb	Type	Hall 2	
			Time	6	
			Level	10	
			Feedback	0	
			Chorus	Type	Chorus 1
				Out Mode	Pre Reverb
	Level	31			
	Delay Time	10			
	Rate	23			
	Depth	5			
	Feedback	0			

■ Patch

Group	Screen	Parameter		
Patch Common	8. Patch Common	Name	Space	
		Patch Level	127	
		Velocity Curve	1	
		Velocity Sens	127	
		Key Mode	Layer	
		Split Point	A4	
Patch L/U PRM	9. Patch L/U PRM	Lower/Upper	Velo Mode	Normal
			Threshold	80
			Key Assign	Poly
			Solo Legato	Off
			Porta	Off
			P. Mode	Auto
			P. Time	12
			PortRx	Off
			Pan Rx	Off
			Palette Lower	10. Palette L - 1 11. Palette L - 2
Level	127			
K. Shift	0			
F. Tune	0			
Cutoff	0			
Reso	0			
Attack	0			
Release	0			
Output/Out	Reverb			
Pan	> <			
Tone	On (L - 2 : Off)			
Zone	C - 1 - G9			
Palette Upper	12. Palette U - 3 13. Palette U - 4	U - 3/U - 4		
			Level	127
			K. Shift	0
			F. Tune	0
			Cutoff	0
			Reso	0
			Attack	0
			Release	0
			Output/Out	Reverb
			Pan	> <
			Tone	Off
			Zone	C - 1 - G9

■ Tone

Group	Screen	Parameter	
Tone PRM	14. Tone PRM	Tone Name	TVF Piano
		Orig. Media	1 1
		Orig. Number	2
		DLM	Off
		Mode	B
		Start	1
		Length	1
Pitch	15. Tone Pitch	P. Coarse	0
		P. Fine	0
		P. KF	+ 100 %
		ENV KF	0 %
		A, Tim	0
		A, Depth	0
		R, Tim	0
TVF	16. Tone TVF	R, Depth	0
		Filter	LPF
		Cutoff	60
		Reso	0
		V. Curve	2
		KF	+ 20 %
		ENV Depth	+ 25
		ENV Depth Velo	50
		TIME KF	+ 50 %
		TIME Velo	6
		TIME R. Velo	5
		A, Tim	0
		A, Lvl	127
		D/B, Tim	25
		D/B, Lvl	120
		D/S, Tim	85
		D/S, Lvl	20
R, Tim	34		
TVA	17. Tone TVA	Level	127
		V. Curve	2
		V. Sens	55
		TIME KF	+ 50 %
		TIME Velo	12
		TIME R. Velo	5
		A, Tim	0
		A, Lvl	127
		D/B, Tim	25
		D/B, Lvl	120
		D/S, Tim	110
		D/S, Lvl	0
LFO	18. Tone LFO	R, Tim	22
		Waveform	Sine
		Rate	105
		Delay Time	4
		Rise Time	2
		Offset	0
		Pitch Mod Depth	0
TVF Mod Depth	0		
TVA Mod Depth	0		

5 ORIGINAL TONE

Media I 1 (Acoustic)

No.	Name	Upper Limit
1	A. PIANO 1	G9
2	A. PIANO 2	C9
3	A. PIANO 3	G # 8
4	A. PIANO 4	G # 8
5	E. PIANO 1	A8
6	E. PIANO 2	G # 8
7	BRIGHT EP	G # 7
8	E. ORGAN 1	A6
9	E. ORGAN 2	B6
10	E. ORGAN 3	E7
11	E. ORGAN 4	G # 6
12	R. ORGAN	D # 9
13	A. GUITAR	A6
14	E. GUITAR 1	F6
15	E. GUITAR 2	F6
16	HEAVY. EG	F7
17	SLAP 1	G7
18	SLAP 2	G7
19	SLAP 3	G7
20	SLAP 4	G7
21	SLAP 5	G7
22	FINGERED	G7
23	PICKED	A4
24	FRETLESS	G7
25	AC. BASS	A # 5
26	CHOIR	G # 6
27	STRINGS 1	C8
28	STRINGS 2	C8
29	SOFT TP	B7
30	TP/TRB 1	C # 8
31	TP/TRB 2	C # 8
32	TP/TRB 3	C # 8
33	BRASS	A7
34	SAX 1	E7
35	SAX 2	E7
36	SAX 3	E7
37	FLUTE	B7
38	SHAKU	F7
39	CALLIOPE	E9
40	PAN PIPES	G # 7
41	BAGPIPES	F # 8
42	BALAPHONE	D7
43	BTRIMBAO	C7
44	KALIMBA	D7
45	CYMBALON	D7
46	VIB	G7
47	MARIMBA	D7

Media I 2 (Synthesizer)

No.	Name	Upper Limit
1	FANTASYNTH	D # 9
2	JP. STRINGS	G8
3	SYN. VOX 1	F9
4	SYN. VOX 2	F9
5	SYNTH HARP	E9
6	DIGI. BELL	B8
7	FANTA BELL	F # 9
8	DIST 5TH ★	G8
9	SOFT SYN	F # 8
10	BASS LP ★	B7
11	BELL LP	F # 7
12	HARP ATK	G7
13	PIZZ	G8
14	EP WAVE	F # 8
15	CLAVE WAVE	D8
16	LITE WAVE	E8
17	B - 3 WAVE	D8
18	SAX WAVE	E9
19	BLO WAVE	D # 8
20	SYN. WAVE 1	B8
21	SYN. WAVE 2	F # 9
22	SYN. PULSE1	F # 8
23	SYN. PULSE2	F # 8
24	SYN. PULSE3	F # 8
25	SYN. SQUARE	F # 9
26	SYN. TRI	F # 8
27	SYN. SAW 1	F # 8
28	SYN. SAW 2	B8
29	SYN. SAW 3	F # 8
30	DIGITAL 1	D8
31	DIGITAL 2	G8
32	DIGITAL 3	B8
33	DIGITAL 4	B8
34	DIGITAL 5	B8
35	DIGITAL 6	B8
36	DIGITAL 7	D8
37	DIGITAL 8	D8
38	DIGITAL 9	D8
39	WHITENOISE	G # 7
40	BREATH	C8
41	SPECTRUM 1	E9
42	SPECTRUM 2	E9
43	NOISE 1	G # 7
44	NOISE 2	D8

Media I 3 (Percussion)

No.	Name	Upper Limit
1	SNAREDRUM1	G5
2	SNAREDRUM2	G5
3	SNAREDRUM3	G5
4	SNAREDRUM4	G5
5	SNAREDRUM5	G5
6	KICK 1	G5
7	KICK 2	G5
8	KICK 3	G5
9	KICK 4	G5
10	TOM 1	G5
11	TOM 2	G5
12	HI - HAT	G5
13	CHINA CYM	G5
14	CRASH CYM	G5
15	RIDE BELL	G5
16	SIDE STICK	G5
17	STICKS	G5
18	CABASA	G5
19	CLAPS	G5
20	COWBELL	G5
21	808 SNARE	G5
22	808 HI - HAT	G5
23	808 TOM	G5
24	ELEC TOM	G5
25	808 CLAVES	G5
26	CLICK	G7
27	AGOGO	D7
28	ORCH HIT	G # 6

* Upper Limit represents the value obtained when the P.KF (Pitch Key Follow) is set to "+100%".

* When the Original Tone with ★ mark is selected, the Pitch Bender may not be turned on.

6 DLM

Sample data is shown below. You may find it useful for your sound creation.

Original Tone			DLM (On)		
Name	Media	Number	Mode	Start	Length
R. ORGAN	1 1	12	A	80	1
R. ORGAN	1 1	12	A	83	1
R. ORGAN	1 1	12	B	29	1
SYN. TRI	1 2	26	B	4	20
SYN. TRI	1 2	26	B	117	1
SYN. TRI	1 2	26	B	125	1
SYN. SAW 3	1 2	29	B	8	1
NOISE 2	1 2	44	B	40	1

7 FACTORY PRESET

■ User Set

Group	Performance Number/Name
1-1	F1 : 46 Ghosties
	F2 : 74 12 StrGuit
	F3 : 43 SpitBrass1
	F4 : 62 ChorusBell
	F5 : 11 D Piano + 1
1-2	F1 : 22 Slow n Low
	F2 : 14 BellRhodes
	F3 : 81 Asialon
	F4 : 24 Pipes 1
	F5 : 54 DLMoogBs 1
1-3	F1 : 25 HornString
	F2 : 66 Wow Jet
	F3 : 47 Mondo Poly
	F4 : 78 Drum Kit
	F5 : 37 Cool Vibes
1-4	F1 : 57 Jazz Split
	F2 : 31 SuperClav
	F3 : 61 Prologue
	F4 : 82 BaliDancer
	F5 : 34 DLM Keys 1
1-5	F1 : 55 Schizoid I
	F2 : 36 * Quasar *
	F3 : 48 There Bs 1
	F4 : 38 Tibet Bell
	F5 : 44 Sax Octave

Group	Performance Number/Name
1-6	F1 : 68 SpaceDream
	F2 : 21 Stirrings
	F3 : 77 GuitarMIDI
	F4 : 45 SynthBones
	F5 : 87 Lab Jet
1-7	F1 : 51 LeadSynth1
	F2 : 83 Hyper Pad
	F3 : 58 DLMoogBs 2
	F4 : 13 Rhodes 1
	F5 : 53 Lead Vox
1-8	F1 : 26 StringsVox
	F2 : 15 Tack Piano
	F3 : 72 Organ
	F4 : 75 Big Guitar
	F5 : 86 Sweepster
1-9	F1 : 63 NiteSprite
	F2 : 17 MIDI Piano
	F3 : 18 BandRhodes
	F4 : 27 Fflute
	F5 : 23 JP - Strings
1-10	F1 : 42 EnsmblHorn
	F2 : 88 G - Finale
	F3 : 28 Calliopead
	F4 : 52 LeadSynth2
	F5 : 71 ClickLesly

■ Performance

No.	Performance Name
11 (1)	D Piano + 1
12 (2)	Grandioso
13 (3)	Rhodes 1
14 (4)	BellRhodes
15 (5)	Tack Piano
16 (6)	AcPia + Str
17 (7)	MIDI Piano
18 (8)	BandRhodes
21 (9)	Stirrings
22 (10)	Slow n Low
23 (11)	JP – Strings
24 (12)	Pipes 1
25 (13)	HornString
26 (14)	StringsVox
27 (15)	Ffflute
28 (16)	Calliopead
31 (17)	SuperClav
32 (18)	StickDecay
33 (19)	DLM Synth
34 (20)	DLM Keys 1
35 (21)	Guitivitty
36 (22)	* Quasar *
37 (23)	Cool Vibes
38 (24)	Tibet Bell
41 (25)	Fuzz Brass
42 (26)	EnsmblHorn
43 (27)	SpitBrass1
44 (28)	Sax Octave
45 (29)	SynthBones
46 (30)	Ghosties
47 (31)	Mondo Poly
48 (32)	There Bs 1

No.	Performance Name
51 (33)	LeadSynth1
52 (34)	LeadSynth2
53 (35)	Lead Vox
54 (36)	DLMoogBs 1
55 (37)	Schizoid !
56 (38)	Slap Bass
57 (39)	Jazz Split
58 (40)	DLMoogBs 2
61 (41)	Prologue
62 (42)	ChorusBell
63 (43)	NiteSprite
64 (44)	Freezer
65 (45)	SweepSpace
66 (46)	Wow Jet
67 (47)	Mother Pad
68 (48)	SpaceDream
71 (49)	ClickLesly
72 (50)	Organ
73 (51)	Perc. Organ
74 (52)	12 StrGuit
75 (53)	Big Guitar
76 (54)	Funk Mute
77 (55)	GuitarMIDI
78 (56)	Drum Kit
81 (57)	Asialon
82 (58)	BaliDancer
83 (59)	Hyper Pad
84 (60)	Shaku Zulu
85 (61)	Shuu – Doon
86 (62)	Sweepster
87 (63)	Lab Jet
88 (64)	G – Finale

■ Patch

No.	Patch Name
A11 (1)	GrandPf Sw
A12 (2)	Grandioso
A13 (3)	Rhodes 1
A14 (4)	BellRhodes
A15 (5)	Tack Piano
A16 (6)	Grand + Strg
A17 (7)	MIDI Piano
A18 (8)	MIDI Stack
A21 (9)	Strings
A22 (10)	Slow n Low
A23 (11)	JP – Strings
A24 (12)	Pipes 1
A25 (13)	Horns + Str
A26 (14)	StringsVox
A27 (15)	Ffflute
A28 (16)	Calliopead
A31 (17)	Dual Clav
A32 (18)	Wave Synth
A33 (19)	DLM Synth
A34 (20)	DLM Pf – Gtr
A35 (21)	Guitivitty
A36 (22)	* Quasar *
A37 (23)	Cool Bells
A38 (24)	Reso Bell
A41 (25)	Mix Brass
A42 (26)	HornEnsmbl
A43 (27)	SynBrass
A44 (28)	SaxOclarve
A45 (29)	Horn Plus
A46 (30)	E. Trumpets
A47 (31)	MIDI Poly2
A48 (32)	DLM Ensmbl

No.	Patch Name
A51 (33)	Lead Synth
A52 (34)	Solo Synth
A53 (35)	Lead Vox
A54 (36)	Reso Lead
A55 (37)	DLM Piano1
A56 (38)	New Slap
A57 (39)	Vibes + Bass
A58 (40)	DLM Bass 1
A61 (41)	Prologue
A62 (42)	PPP Vox
A63 (43)	NiteSprite
A64 (44)	D50 Layer
A65 (45)	Sweep Str
A66 (46)	Wow Stack
A67 (47)	Pad BBrass
A68 (48)	EE Pad
A71 (49)	ClickLesly
A72 (50)	FullOrgan
A73 (51)	ClickOrgan
A74 (52)	12 StrGuit
A75 (53)	Big Guitar
A76 (54)	FunkGit Sw
A77 (55)	GuitPnoStr
A78 (56)	DigitalSax
A81 (57)	Asia
A82 (58)	BaliDancer
A83 (59)	HyperFlute
A84 (60)	Shak Filt
A85 (61)	Shuu – Doon
A86 (62)	Talking
A87 (63)	Lab Jet
A88 (64)	G – Finale

No.	Patch Name
B11 (65)	Ghost Vox1
B12 (66)	Wonderous1
B13 (67)	DLM Bass 2
B14 (68)	SynBones
B15 (69)	Ghost Vox2
B16 (70)	Jan Bass 1
B17 (71)	Reso 2Bell
B18 (72)	DLM Bass 3
B21 (73)	-. B21
B22 (74)	-. B22
B23 (75)	-. B23
B24 (76)	-. B24
B25 (77)	-. B25
B26 (78)	-. B26
B27 (79)	-. B27
B28 (80)	-. B28
B31 (81)	-. B31
B32 (82)	-. B32
B33 (83)	-. B33
B34 (84)	-. B34
B35 (85)	-. B35
B36 (86)	-. B36
B37 (87)	-. B37
B38 (88)	-. B38
B41 (89)	-. B41
B42 (90)	-. B42
B43 (91)	-. B43
B44 (92)	-. B44
B45 (93)	-. B45
B46 (94)	-. B46
B47 (95)	-. B47
B48 (96)	-. B48

No.	Patch Name
B51 (97)	-. B51
B52 (98)	-. B52
B53 (99)	-. B53
B54 (100)	-. B54
B55 (101)	-. B55
B56 (102)	-. B56
B57 (103)	-. B57
B58 (104)	-. B58
B61 (105)	-. B61
B62 (106)	-. B62
B63 (107)	-. B63
B64 (108)	-. B64
B65 (109)	-. B65
B66 (110)	-. B66
B67 (111)	-. B67
B68 (112)	-. B68
B71 (113)	-. B71
B72 (114)	-. B72
B73 (115)	-. B73
B74 (116)	-. B74
B75 (117)	-. B75
B76 (118)	-. B76
B77 (119)	-. B77
B78 (120)	-. B78
B81 (121)	-. B81
B82 (122)	-. B82
B83 (123)	-. B83
B84 (124)	-. B84
B85 (125)	-. B85
B86 (126)	-. B86
B87 (127)	-. B87
B88 (128)	-. B88

* No sound data is written in the some Patches of B group preprogrammed from the manufacturer, because the Name Delete is being done (see page 158 and 166). Use it for a destination patch where the edited patch is to be written.

■ Tone

No.	Tone Name
a11	A. Piano p1
a12	A. Piano f1
a13	A. Piano p2
a14	A. Piano f2
a15	E. Piano pp
a16	E. Piano ff
a17	Cymbalon 1
a18	E. Piano 1
a21	Digi Bell1
a22	E. Piano 2
a23	DigiAttack
a24	A. Piano 3
a25	Strings 1
a26	A. Piano 4
a27	SynRhodes1
a28	Vox Sweep
a31	Agogo 1
a32	RMIcomp 1
a33	Strings 2
a34	Str Pad 1
a35	Rosin. Pad1
a36	Jp. Strings1
a37	Strings 3
a38	DLM STR P1
a41	DLM STR P2
a42	TrumpBone1
a43	Strings 4
a44	Choir 1
a45	Syn Vox 1
a46	Pan Pipes1
a47	Flute 1
a48	Calliope 1

No.	Tone Name
a51	Wave 1Clav
a52	Wave 2Clav
a53	Digital 1
a54	Digital 2
a55	ToothPk5In
a56	DLM P – Gtr
a57	MarimbaSp
a58	Digi Bell2
a61	WetDigital
a62	FItDigital
a63	Digital 3
a64	Vibes 1
a65	FantaBell1
a66	Lite Wave2
a67	Str Pad 2
a68	DLM SYNBR3
a71	DLM HORN 2
a72	REAL HORN
a73	TrumpBone2
a74	BrassEns 1
a75	Saw 2
a76	Saw 1
a77	Brass 1
a78	Sax 1
a81	Sax 2
a82	Sax 3
a83	TrumpBone3
a84	DLM HORN 1
a85	SoftTrump1
a86	Syn. Mut – Tp
a87	Lite Bell1
a88	Polysyn 1

No.	Tone Name
b11	Syn. Saw 2
b12	Syn. Saw 1
b13	Solo2Synth
b14	GhostChoir
b15	Syn Vox 2
b16	SlapRezBas
b17	DLM 1
b18	DLM 2
b21	SlapBass2 +
b22	Vibes 2
b23	AcoustBas1
b24	DLM BASS 1
b25	DLM BASS 2
b26	Prologue
b27	Syn. VoxPad
b28	Str Pad 3
b31	Reso. Synth
b32	FantaBell2
b33	Syn Vox 3
b34	DLM RESPAD
b35	Fast Str
b36	Noise Fall
b37	Vibe Rise
b38	Str Pad 3
b41	Happy Org1
b42	Slow Str 1
b43	GhostChor2
b44	JP Pad 1
b45	Lesli Org2
b46	Click Org1
b47	E. Organ 10
b48	E. Organ 11

No.	Tone Name
b51	R. Organ 1
b52	B - 3 Wave
b53	A. Guitar 1
b54	A. Guitar 2
b55	Syn. Slap 1
b56	Heavy. Eg 2
b57	Dist 5th 1
b58	Funk Git 1
b61	Funk Git 2
b62	A. Guitar 3
b63	BELL Sweep
b64	Sax 4
b65	Reso. Syn 2
b66	Cymbalon 2
b67	A. Guitar 4
b68	PolySyn 3
b71	Balaphone
b72	Pan Pipes2
b73	Syn Vox 4
b74	Shaku 1
b75	Shuu -
b76	- Doon
b77	Sweep Down
b78	Vox
b81	Sweep up
b82	FretIsBas1
b83	Cymbal Fall
b84	Orch Hit
b85	Snare Drum
b86	Crash Cym
b87	A. Piano 5
b88	SynRhodes2

Rhythm Setup

		Original Tone			
		Name	Media	Number	Source Key
	28	KICK 2	3	7	C4
	29	HI - HAT	3	12	D#4
	30	HI - HAT	3	12	D#4
	31	TOM 2	3	11	G3
	32	TOM 2	3	11	C4
	33	TOM 1	3	10	G#4
	34	TOM 2	3	11	F4
	35	KICK 2	3	7	C4
C2	36	KICK 1	3	6	A#3
	37	SIDE STICK	3	16	C#4
	38	SNAREDRUM5	3	5	D4
	39	CLAPS	3	19	A#3
	40	SNAREDRUM1	3	1	C#4
	41	TOM 1	3	10	A3
	42	HI - HAT	3	12	E4
	43	TOM 2	3	11	G3
	44	HI - HAT	3	12	E4
	45	TOM 1	3	10	D4
	46	HI - HAT	3	12	E4
	47	TOM 2	3	11	C4
C3	48	TOM 1	3	10	G#4
	49	CRASH CYM	3	14	D4
	50	TOM 2	3	11	F4
	51	RIDE BELL	3	15	B3
	52	CHINA CYM	3	13	C4
	53	STICKS	3	17	C4
	54	SNAREDRUM1	3	1	Off
	55	CRASH CYM	3	14	A4
	56	COWBELL	3	20	B3
	57	CRASH CYM	3	14	F4
	58	SNAREDRUM3	3	3	D#4
	59	RIDE BELL	3	15	C#4
C4	60	KICK 3	3	8	C4
	61	STICKS	3	17	A4
	62	808 SNARE	3	21	F#4
	63	CLAPS	3	19	B2
	64	SNAREDRUM2	3	2	F#3
	65	808 TOM	3	23	A2
	66	808 HI - HAT	3	22	E4
	67	808 TOM	3	23	E3
	68	808 HI - HAT	3	22	E4
	69	CABASA	3	18	A#3
	70	808 HI - HAT	3	22	E4
	71	808 CLAVES	3	25	E4
C5	72	KICK 4	3	9	C4
	73	SNAREDRUM1	3	1	D#4
	74	SNAREDRUM4	3	4	D4
	75	SNAREDRUM1	3	1	Off
	76	SNAREDRUM1	3	1	Off
	77	SNAREDRUM1	3	1	Off
	78	SNAREDRUM1	3	1	Off
	79	808 SNARE	3	21	C4
	80	808 TOM	3	23	C#3
	81	808 CLAVES	3	25	B3
	82	SNAREDRUM1	3	1	Off
C6	83	808 TOM	3	23	G3
	84	KICK 3	3	8	C4
	85	KICK 4	3	9	C4
	86	SNAREDRUM3	3	3	D4
	87	SNAREDRUM4	3	4	C4
	88	SNAREDRUM5	3	5	C4
	89	ELEC TOM	3	24	B3
	90	808 HI - HAT	3	22	D#4
	91	ELEC TOM	3	24	E4
	92	CHINA CYM	3	13	C#4
	93	ELEC TOM	3	24	A4
	94	RIDE BELL	3	15	A4
	95	808 TOM	3	23	G2
C7	96	SNAREDRUM1	3	1	B3
	97	CABASA	3	18	F#3
	98	BREATH	2	40	D4
	99	CHINA CYM	3	13	D#4
	100	BREATH	2	40	C6
	101	NOISE 1	2	43	C4
	102	HI - HAT	3	12	A0
	103	NOISE 1	2	43	G3

* When the Source Key is set to Off, no sound is produced.

8 ABOUT MIDI

MIDI stands for Musical Instrument Digital Interface, and is a world - wide standard for exchanging musical data between instruments to play notes, select sounds, etc. Devices which are MIDI compatible can exchange musical data, regardless of the manufacturer and model of the device. Musical data such as notes being played or pedals being pressed are handled by MIDI as "MIDI messages".

1. How MIDI messages are transmitted and received

First, we will explain how MIDI messages are transmitted and received.

MIDI connectors

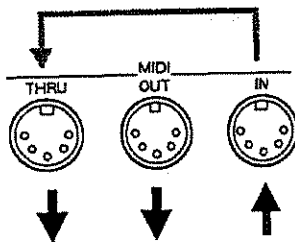

- MIDI IN: Receive MIDI messages from another MIDI device.
- MIDI OUT: Transmit MIDI messages from this device.
- MIDI THRU: Re - transmit (without modifying) the messages received at MIDI IN.

*MIDI THRU connectors can be used to connect several MIDI devices, but in practice, you should consider four or five as the limit. If more devices than this are connected, MIDI messages may become garbled and unreadable.

MIDI channels

MIDI uses "channels" to independently transmit messages to two or more MIDI devices using a single MIDI cable.

You may think of MIDI channels as being like the channels of a TV. By selecting channels on a TV receiver, you can receive a variety of different stations. When the transmitting channel matches the receiving channel, the data of that channel is received.

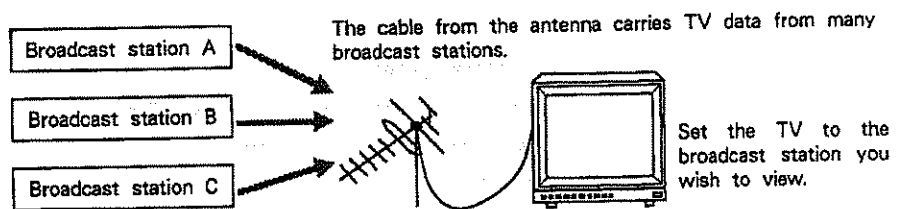

MIDI uses sixteen channels, numbered 1 — 16. MIDI messages will be received by an instrument whose reception channel matches the transmission channel of the transmitting device. If MIDI channels are set as shown in the following diagram, sound module B will sound when the keyboard is played.

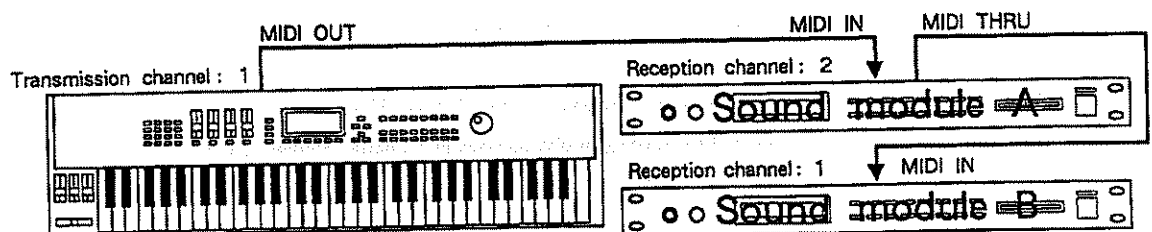

2. MIDI messages used by the D-70

In order to transmit many different types of musical information, MIDI uses various types of message. MIDI messages can be divided into messages that are handled independently by each channel (Channel messages), and messages that are handled regardless of the channel (System messages).

■ Messages handled by each channel (Channel messages)

These messages are used to transmit musical performance gestures. Normally, most musical control can be accomplished using only these messages. The settings of each MIDI sound source will determine the effect caused by each type of MIDI message.

● Note messages

These messages transmit keyboard data. Note messages include the following data.

Note number	the key position
Note on	a note has been played
Note off	a note has been released
Velocity	the speed (velocity) at which the note was played

*The note number indicates the key position over a range of 0 — 127, where a note number of 60 indicates middle C (C4).

● Pitch Bender messages

These messages transmit changes in pitch.

● **Aftertouch messages** Aftertouch is divided into two types; Channel Aftertouch and Polyphonic Aftertouch. Channel Aftertouch applies to an entire MIDI channel. Regardless of the key you press down strongly, all notes will be affected in the same way.

Polyphonic Aftertouch controls each note independently. Even within the same MIDI channel, pressing down strongly on a specific note will affect only the sound of that note. The D-70 transmits and receives only Channel Aftertouch.

The Aftertouch settings of a device will determine how Aftertouch messages are transmitted and received.

● Program Change messages

Program Change messages select sounds using a Program Number of 1 — 128. The D-70 can receive Program Change messages to select Performances and Patches. Program Change messages received on the System Setup Control channel will select Performances. Program Change messages received on the channel of a Part will select Patches for that Part. For details see P.49.

● **Control Change data** These messages allow you to control Vibrato, Hold, Volume, Pan, etc, for more musically expressive playing. Each function is distinguished by a Control Number. The functions that can be controlled will depend on each MIDI device.

■ Messages handled regardless of the channel (System messages)

System messages include Exclusive messages, messages for synchronization, and messages to keep a MIDI system running correctly. Of these, the D - 70 uses mainly Exclusive messages.

- **Exclusive messages** Exclusive messages are used to transmit data that is unique to each device, such as sound data. In general, these messages allow data to be transferred between devices of the same model made by the same manufacturer. Exclusive messages allow you to transmit sound data (instead of Program Change messages) to a sequencer to be recorded, or transmit sound data to another D - 70. When transferring exclusive data between two devices, the Unit Numbers (☞ P.137) of the two MIDI devices must be set to match.

● The MIDI Implementation Chart

Although MIDI allows many devices to communicate with each other, this does not mean that each device will be able to transmit and receive all types of data.

For example, if you wish to transmit Aftertouch messages from a keyboard to control some aspect of the sound, there will be no result unless the MIDI sound module receiving the Aftertouch messages is able to actually respond to Aftertouch messages. In such cases, only the data which is common to both devices can be meaningfully transmitted.

As a quick reference of its MIDI capabilities, the operating manual of each device includes a "MIDI Implementation Chart" (☞ P.211). By comparing the MIDI Implementation Charts of two devices, you can determine the types of MIDI message they will be able to exchange. Since the chart is always a standard size, you can fold together the charts of the transmitting and receiving devices for convenient comparison.

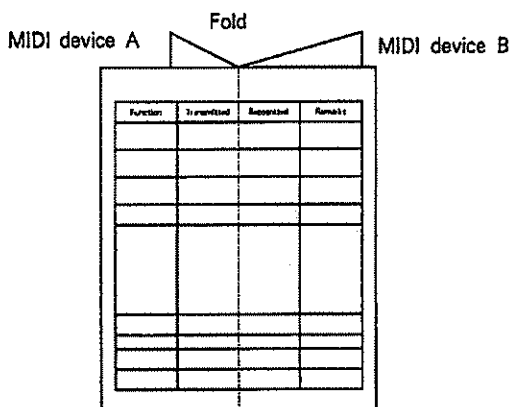

*For details of MIDI message handling, refer to "Roland Exclusive Messages" (☞ P.198) and "MIDI Implementation" (☞ P.202).

Roland Exclusive Messages

1. Data Format for Exclusive Messages

Roland's MIDI implementation uses the following data format for all exclusive messages (type IV):

Byte	Description
FOH	Exclusive status
41H	Manufacturer ID (Roland)
DEV	Device ID
MDL	Model ID
CMD	Command ID
[BODY]	Main data
F7H	End of exclusive

MIDI status: FOH, F7H

An exclusive message must be flanked by a pair of status codes, starting with a Manufacturer-ID immediately after FOH (MIDI version 1.0).

Manufacturer-ID: 41H

The Manufacturer-ID identifies the manufacturer of a MIDI instrument that triggers an exclusive message. Value 41H represents Roland's Manufacturer-ID.

Device-ID: DEV

The Device-ID contains a unique value that identifies the individual device in the multiple implementation of MIDI instruments. It is usually set to 00H - 0FH, a value smaller by one than that of a basic channel, but value 00H - 1FH may be used for a device with multiple basic channels.

Model-ID: MDL

The Model-ID contains a value that uniquely identifies one model from another. Different models, however, may share an identical Model-ID if they handle similar data.

The Model-ID format may contain 00H in one or more places to provide an extended data field. The following are examples of valid Model-IDs, each representing a unique model:

- 01H
- 02H
- 03H
- 00H, 01H
- 00H, 02H
- 00H, 00H, 01H

Command-ID: CMD

The Command-ID indicates the function of an exclusive message. The Command-ID format may contain 00H in one or more places to provide an extended data field. The following are examples of valid Command-IDs, each representing a unique function:

- 01H
- 02H
- 03H
- 00H, 01H
- 00H, 02H
- 00H, 00H, 01H

Main data: BODY

This field contains a message to be exchanged across an interface. The exact data size and contents will vary with the Model-ID and Command-ID.

2. Address-mapped Data Transfer

Address mapping is a technique for transferring messages conforming to the data format given in Section 1. It assigns a series of memory-resident records -- waveform and tone data, switch status, and parameters, for example -- to specific locations in a machine-dependent address space, thereby allowing access to data residing at the address a message specifies.

Address-mapped data transfer is therefore independent of models and data categories. This technique allows use of two different transfer procedures: one-way transfer and handshake transfer.

One-way transfer procedure (See Section 3 for details.)

This procedure is suited for the transfer of a small amount of data. It sends out an exclusive message completely independent of a receiving device status.

Connection Diagram

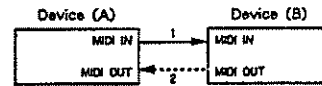

Connection at point 2 is essential for "Request data" procedures. (See Section 3.)

Handshake-transfer procedure (See Section 4 for details.)

This procedure initiates a predetermined transfer sequence (handshaking) across the interface before data transfer takes place. Handshaking ensures that reliability and transfer speed are high enough to handle a large amount of data.

Connection Diagram

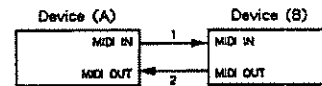

Connection at points 1 and 2 is essential.

Notes on the above two procedures

- *There are separate Command-IDs for different transfer procedures.
- *Devices A and B cannot exchange data unless they use the same transfer procedure, share identical Device-ID and Model ID, and are ready for communication.

3. One-way Transfer Procedure

This procedure sends out data all the way until it stops and is used when the messages are so short that answerbacks need not be checked.

For long messages, however, the receiving device must acquire each message in time with the transfer sequence, which inserts intervals of at least 20 milliseconds in between.

Types of Messages

Message	Command ID
Request data 1	RQ1 (11H)
Data set 1	DT1 (12H)

Request data # 1: RQ1 (11H)

This message is sent out when there is a need to acquire data from a device at the other end of the interface. It contains data for the address and size that specify designation and length, respectively, of data required.

On receiving an RQ1 message, the remote device checks its memory for the data address and size that satisfy the request.

If it finds them and is ready for communication, the device will transmit a "Data set 1 (DT1)" message, which contains the requested data. Otherwise, the device will send out nothing.

Byte	Description
FOH	Exclusive status
41H	Manufacturer ID (Roland)
DEV	Device ID
MDL	Model ID
11H	Command ID
aaH	Address MSB
⋮	⋮
	LSB
ssH	Size MSB
⋮	⋮
	LSB
sum	Check sum
F7H	End of exclusive

*The size of the requested data does not indicate the number of bytes that will make up a DT1 message, but represents the address fields where the requested data resides.

*Some models are subject to limitations in data format used for a single transaction. Requested data, for example, may have a limit in length or must be divided into predetermined address fields before it is exchanged across the interface.

*The same number of bytes comprises address and size data, which, however, vary with the Model-ID.

*The error checking process uses a checksum that provides a bit pattern where the least significant 7 bits are zero when values for an address, size, and that checksum are summed.

Data set 1 : DT1 (12H)

This message corresponds to the actual data transfer process. Because every byte in the data is assigned a unique address, a DT1 message can convey the starting address of one or more data as well as a series of data formatted in an address-dependent order.

The MIDI standards inhibit non-real time messages from interrupting an exclusive one. This fact is inconvenient for the devices that support a "soft-through" mechanism. To maintain compatibility with such devices, Roland has limited the DT1 to 255 bytes so that an excessively long message is sent out in separate segments.

Byte	Description
F0H	Exclusive
41H	Manufacturer ID (Roland)
DEV	Device ID
MDL	Model ID
12H	Command ID
aaH	Address MSB
⋮	⋮
	LSB
ddH	Data
⋮	⋮
sum	Check sum
F7H	End of exclusive

*A DT1 message is capable of providing only the valid data among those specified by an RQ1 message.

*Some models are subject to limitations in data format used for a single transaction. Requested data, for example, may have a limit in length or must be divided into predetermined address fields before it is exchanged across the interface.

*The number of bytes comprising address data varies from one Model-ID to another.

*The error checking process uses a checksum that provides a bit pattern where the least significant 7 bits are zero when values for an address, size, and that checksum are summed.

Example of Message Transactions

● Device A sending data to Device B
Transfer of a DT1 message is all that takes place.

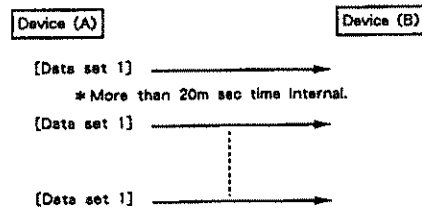

● Device B requesting data from Device A
Device B sends an RQ1 message to Device A. Checking the message, Device A sends a DT1 message back to Device B.

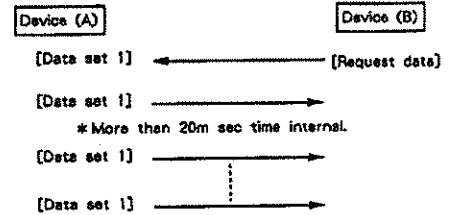

4. Handshake - Transfer Procedure

Handshaking is an interactive process where two devices exchange error checking signals before a message transaction takes place, thereby increasing data reliability. Unlike one-way transfer that inserts a pause between message transactions, handshake transfer allows much speedier transactions because data transfer starts once the receiving device returns a ready signal.

When it comes to handling large amounts of data -- sampler waveforms and synthesizer tones over the entire range, for example -- across a MIDI interface, handshaking transfer is more efficient than one-way transfer.

Types of Messages

Message	Command ID
Went to send data	WSD (40H)
Request data	RQD (41H)
Data set	DAT (42H)
Acknowledge	ACK (43H)
End of data	EOD (45H)
Communication error	ERR (4EH)
Rejection	RJC (4FH)

Want to send data : WSD (40H)

This message is sent out when data must be sent to a device at the other end of the interface. It contains data for the address and size that specify designation and length, respectively, of the data to be sent.

On receiving a WSD message, the remote device checks its memory for the specified data address and size which will satisfy the request. If it finds them and is ready for communication, the device will return an "Acknowledge (ACK)" message.

Otherwise, it will return a "Rejection (RJC)" message.

Byte	Description
F0H	Exclusive status
41H	Manufacturer ID (Roland)
DEV	Device ID
MDL	Model ID
40H	Command ID
aaH	Address MSB
⋮	⋮
	LSB
ssH	Size MSB
⋮	⋮
	LSB
sum	Check sum
F7H	End of exclusive

*The size of the data to be sent does not indicate the number of bytes that make up a "Data set (DAT)" message, but represents the address fields where the data should reside.

*Some models are subject to limitations in data format used for a single transaction. Requested data, for example, may have a limit in length or must be divided into predetermined address fields before it is exchanged across the interface.

*The same number of bytes comprises address and size data, which, however, vary with the Model-ID.

*The error checking process uses a checksum that provides a bit pattern where the least significant 7 bits are zero when values for an address, size, and that checksum are summed.

Request data : RQD (41H)

This message is sent out when there is a need to acquire data from a device at the other end of the interface. It contains data for the address and size that specify designation and length, respectively, of data required.

On receiving an RQD message, the remote device checks its memory for the data address and size which satisfy the request. If it finds them and is ready for communication, the device will transmit a "Data set (DAT)" message, which contains the requested data. Otherwise, it will return a "Rejection (RJC)" message.

Byte	Description
F0H	Exclusive status
41H	Manufacturer ID (Roland)
DEV	Device ID
MDL	Model ID
41H	Command ID
aaH	Address MSB
.....
.....	LSB
ssH	Size MSB
.....
.....	LSB
sum	Check sum
F7H	End of exclusive

*The size of the requested data does not indicate the number of bytes that make up a "Data set (DAT)" message, but represents the address fields where the requested data resides.

*Some models are subject to limitations in data format used for a single transaction. Requested data, for example, may have a limit in length or must be divided into predetermined address fields before it is exchanged across the interface.

*The same number of bytes comprises address and size data, which, however, vary with the Model-ID.

*The error checking process uses a checksum that provides a bit pattern where the least significant 7 bits are zero when values for an address, size, and that checksum are summed.

Data set : DAT (42H)

This message corresponds to the actual data transfer process. Because every byte in the data is assigned a unique address, the message can convey the starting address of one or more data as well as a series of data formatted in an address-dependent order.

Although the MIDI standards inhibit non-real time messages from interrupting an exclusive one, some devices support a "soft-through" mechanism for such interrupts. To maintain compatibility with such devices, Roland has limited the DAT to 256 bytes so that an excessively long message is sent out in separate segments.

Byte	Description
F0H	Exclusive status
41H	Manufacturer ID (Roland)
DEV	Device ID
MDL	Model ID
42H	Command ID
aaH	Address MSB
.....
.....	LSB
ddH	Data
.....
sum	Check sum
F7H	End of exclusive

*A DAT message is capable of providing only the valid data among those specified by an RQD or WSD message.

*Some models are subject to limitations in data format used for a single transaction. Requested data, for example, may have a limit in length or must be divided into predetermined address fields before it is exchanged across the interface.

*The number of bytes comprising address data varies from one model ID to another.

*The error checking process uses a checksum that provides a bit pattern where the least significant 7 bits are zero when values for an address, size, and that checksum are summed.

Acknowledge : ACK (43H)

This message is sent out when no error was detected on reception of a WSD, DAT, "End of data (EOD)", or some other message and a requested setup or action is complete. Unless it receives an ACK message, the device at the other end will not proceed to the next operation.

Byte	Description
F0H	Exclusive status
41H	Manufacturer ID (Roland)
DEV	Device ID
MDL	Model ID
43H	Command ID
F7H	End of exclusive

End of data : EOD (45H)

This message is sent out to inform a remote device of the end of a message. Communication, however, will not come to an end unless the remote device returns an ACK message even though an EOD message was transmitted.

Byte	Description
F0H	Exclusive status
41H	Manufacturer ID (Roland)
DEV	Device ID
MDL	Model ID
45H	Command ID
F7H	End of exclusive

Communications error : ERR (4EH)

This message warns the remote device of a communications fault encountered during message transmission due, for example, to a checksum error. An ERR message may be replaced with a "Rejection (RJC)" one, which terminates the current message transaction in midstream.

When it receives an ERR message, the sending device may either attempt to send out the last message a second time or terminate communication by sending out an RJC message.

Byte	Description
F0H	Exclusive status
41H	Manufacturer ID (Roland)
DEV	Device ID
MDL	Model ID
4EH	Command ID
F7H	End of exclusive

Rejection : RJC (4FH)

This message is sent out when there is a need to terminate communication by overriding the current message. An RJC message will be triggered when :

- a WSD or RQD message has specified an illegal data address or size.
- the device is not ready for communication.
- an illegal number of addresses or data has been detected.
- data transfer has been terminated by an operator.
- a communications error has occurred.

An ERR message may be sent out by a device on either side of the interface. Communication must be terminated immediately when either side triggers an ERR message.

Byte	Description
FOH	Exclusive status
41H	Manufacturer ID (Roland)
DEV	Device ID
MDL	Model ID
4FH	Command ID
F7H	End of exclusive

Example of Message Transactions

● Data transfer from device (A) to device (B).

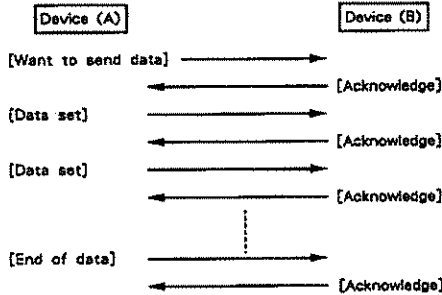

● Device (A) requests and receives data from device (B).

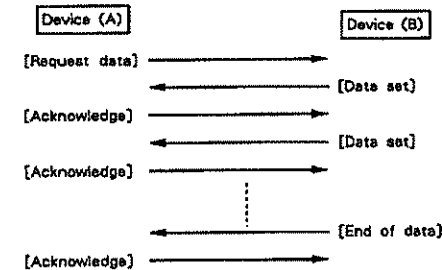

● Error occurs while device (A) is receiving data from device (B).

1) Data transfer from device (A) to device (B).

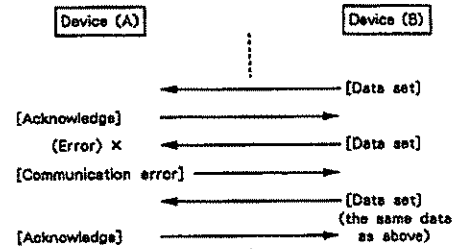

2) Device (B) rejects the data re-transmitted, and quits data transfer.

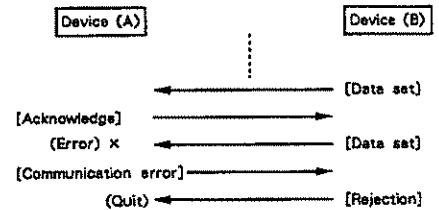

3) Device (A) immediately quits data transfer.

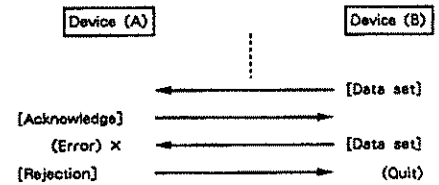

1. TRANSMITTED DATA

The D-70 transmits data on Performance/MIDI OUT/Tx channels each of which is assigned 4 sections and on System/Control channels. Each of these channels must be independent of the remainder.

The Performance/MIDI OUT/Tx channels are used to transmit keyboard data to control an external sound source, simulating a master keyboard. System/Control channels are used to simulate operations of play mode through external device such as sequencer. The D-70 will transmit on these channels only during play mode.

Note Event

Note event is transmitted on MIDI channels set Performance/MIDI OUT/Tx channels.

* The channel on which data is to be transmitted depends on the key mode and velocity mode of Performance/MIDI OUT. Transpose and velocity curve change are possible before transmission.

Note event is also transmitted on MIDI channel assigned System/Control channel.

* Simple key information is transmitted on this channel: information can be processed as necessary after reception.

Note off

Status	Second	Third	
8nH	kkH	vvH	
n = MIDI channel number	: 0H - FH (0 - 15)	0 = ch.1 15 = ch.16	
kk = Note number	: 00H - 7FH (0 - 127)		
vv = Velocity	: 01H - 7FH (1 - 127)		

Note on

Status	Second	Third	
9nH	kkH	vvH	
n = MIDI channel number	: 0H - FH (0 - 15)	0 = ch.1 15 = ch.16	
kk = Note number	: 00H - 7FH (0 - 127)		
vv = Velocity	: 01H - 7FH (1 - 127)		

Control change

Transmitted on MIDI channels set to Performance/MIDI OUT/Tx Ch.

* Most of all controllers can be set to any one of function numbers (0-95) of control change. Volume (No.7) is memorized.

Function settable controller	Fixed function controller
Bender	Hold Pedal (64 Hold1)
Aftertouch	
Modulation	
Cl/EXP Pedal	
Pedal switch	

Control change is transmitted on channels set to System/Control channel.

* Function of controllers and control changes are permanently defined.

Controller	Control change
Modulation	1 (Modulation)
Brightness	2 (Breath)
EXP Pedal / Cl	6 (Data Entry)
Tone Palette Slider-1	16 (General Purpose 1)
Tone Palette Slider-2	17 (2)
Tone Palette Slider-3	18 (3)
Tone Palette Slider-4	19 (4)
Hold Pedal	64 (Hold1)
Portamento button	65 (Portamento)
Pedal switch	66 (General Purpose 5)
Tone palette button	81 (6)
Play button	82 (7)
Tone/Zone Select button	83 (8)

Status	Second	Third	
BnH	ccH	vvH	
n = MIDI channel number	: 0H - FH (0 - 15)	0 = ch.1 15 = ch.16	
cc = control number	: 00H - 5FH (0 - 95)		
vv = control value	: 00H - 7FH (0 - 127)		

Program Change

The following data are transmitted on MIDI channels set to Performance/MIDI OUT/Tx Ch.

- * The number set to a particular section when performance is selected.
- * The program number being edited in a particular section.

The following data are transmitted on MIDI channels set to System/MIDI Tx Ch.

- * Performance number when performance is selected.

Status	Second	
CnH	ppH	
n = MIDI channel number	: 0H - FH (0 - 15)	0 = ch.1 15 = ch.16
pp = Program number	: 00H - 7FH (0 - 127)	

Channel Aftertouch

Transmitted on MIDI channels set to Performance/MIDI OUT/Tx Ch.

- * Most of the channels can be set for transmitting channel aftertouch.

Settable controllers
Bender
Aftertouch
Modulation
Cl/EXP Pedal
Pedal switch

Transmitted on MIDI channel set to System/Control channel.

- * Transmits aftertouch information of the keyboard as it is.

Status	Second	
DnH	vvH	
n = MIDI channel number	: 0H - FH (0 - 15)	0 = ch.1 15 = ch.16
vv = Value	: 00H - 7FH (0 - 127)	

Pitch Bend Change

Transmitted on MIDI channel set to Performance/MIDI OUT/Tx Ch.

- * Most of the channels can be set for transmitting channel aftertouch.

Settable controllers
Bender
Aftertouch
Modulation
Cl/EXP Pedal
Pedal switch

Transmitted on MIDI channel set to System/Control channel.

- * Transmits the value of bender lever as it is.

Status	Second	Third	
EnH	lH	mmH	
n = MIDI channel number	: 0H - FH (0 - 15)	0 = ch.1 15 = ch.16	
l = Value lower 7 bits	: 00H - 7FH (-64 - +63) /8192		
mm = Value upper 7 bits	: 00H - 7FH (-64 - +63) *64/8192		

Exclusive

The D-70 can transmit and receive various parameters through exclusive message. For details, refer to Sections, Roland Exclusive Messages and 3. Exclusive Communications.

Status	
POH	System exclusive
F7H	EOX (End of Exclusive)

Active Sensing

The D-70 transmits this message to allow the device (s) it connecting to check MIDI connection and the like for continuity. Sends this message when no event has occurred 250 ms after the previous event.

Status
FEH

2. RECOGNIZED RECEIVE DATA

The D-70 is in receive status except during ROM play mode. Receives MIDI information through 6 MIDI Performance/PART SET/RX channels set to part 1 to rhythm part, and through the MIDI channel set to System/Control channel. A Performance/PART SET/RX Ch can be assigned more than one part channel but only one MIDI channel can be set to System/Control channel. Data received through Performance/PART SET/RX Ch are used to enable the particular function to control internal sound source for reproducing multi-timbre. Data received on System/Control channel are to reproduce play patterns stored in the sequencer and the like during play mode.

■ Note Event

Receives this message on a MIDI channel set to Performance/PART SET/RX Ch.

* When received, each part is sounded.

Receives on a MIDI channel assigned System/Control Ch.

* The parts set to Performance/KB PART will sound as if they are directly driven from a keyboard.

● Note off

Status	Second	Third	
8nH	kkH	vvH	
9nH	kkH	00H	
n = MIDI channel number	: 0H - FH (0 - 15)	0 = ch.1 15 = ch.16	
kk = Note number	: 00H - 7FH (0 - 127)		
vv = Velocity	: 00H - 7FH (0 - 127)		

9n kk 00 is translated as 8n kk 40.

● Note on

Status	Second	Third	
9nH	kkH	vvH	
n = MIDI channel number	: 0H - FH (0 - 15)	0 = ch.1 15 = ch.16	
kk = Note number	: 00H - 7FH (0 - 127)		
vv = Velocity	: 01H - 7FH (1 - 127)		

■ Control change

Receives this message on MIDI channel set to Performance/PART SET/RX Ch.

* Can recognize the following control change numbers.

Control Change	Function
1 (Modulation)	Assignable (Pitch, TVF, TVA, LFO, etc.)
5 (Portamento time)	Portamento time (Mono code only)
7 (Volume)	Part volume
10 (Panpot)	Panpot
64 (Hold1)	Hold or Sostenuto
65 (Portamento)	Portamento switch (Mono code only)

Receives this message also on MIDI channel set to System/Control Ch.

* The value in a control change message acts as if the corresponding control on the panel is set to this value.

Control Change	Corresponding control on the panel
1 (Modulation)	Modulation
2 (Breath)	Brightness
6 (Data Entry)	CI/EXP Pedal
16 (General Purpose 1)	Tone Palette Slider-1
17 ()	Tone Palette Slider-2
18 ()	Tone Palette Slider-3
19 ()	Tone Palette Slider-4
64 (Hold1)	Hold Pedal
65 (Portamento)	Portamento button
80 (General Purpose 6)	Pedal switch
81 ()	Tone palette button
82 ()	Play button
83 ()	Tone/Zone select button

Status	Second	Third	
8nH	ccH	vvH	
n = MIDI channel number	: 0H - FH (0 - 15)	0 = ch.1 15 = ch.16	
cc = control number	: 00H - 53H (0 - 83)		
vv = control value	: 00H - 7FH (0 - 127)		

■ Program Change

Receives this message on MIDI channel set to Performance/PART SET/RX Ch.

* Changes patch of each part.
* 0 - 127 are interpreted as A11 - B88, respectively. Internal/card are set to the currently selected performance.

Receives this message on MIDI channel set to System/Control channel.

* Changes performance.
* 0 - 63 are interpreted as Internal 11 - 88, and 64 - 127 as card 11 - 88 respectively.

Status	Second	
CnH	ppH	
n = MIDI channel number	: 0H - FH (0 - 15)	0 = ch.1 15 = ch.16
pp = Program number	: 00H - 7FH (0 - 127)	

■ Channel Aftertouch

Receives this message on MIDI channel set to Performance/PART SET/RX Ch.

* Can be used to set functions.

Receives this message on MIDI channel set to System/Control Ch.

* Simulates aftertouch on a keyboard.

Status	Second	
DnH	vvH	
n = MIDI channel number	: 0H - FH (0 - 15)	0 = ch.1 15 = ch.16
vv = Value	: 00H - 7FH (0 - 127)	

■ Pitch Bend Change

Receives on MIDI channel set to Performance/PART SET/RX Ch.

* Can be used to set functions.

Receives this message on MIDI channel set to System/Control Ch.

* Simulates bender lever.

Status	Second	Third	
EnH	iiH	mmH	
n = MIDI channel number	: 0H - FH (0 - 15)	0 = ch.1 15 = ch.16	
ii = Value lower 7 bits	: 00H - 7FH (-64 - +63) /8192		
mm = Value upper 7 bits	: 00H - 7FH (-64 - +63) *64/8192		

■ Exclusive

The D-70 can transmit and receive various parameters through exclusive message. For details, refer to Sections, Roland Exclusive Messages and 3. Exclusive Communications.

Status	
FOH	System exclusive
F7H	EOX (End of Exclusive)

■ Active sensing

Having received this message, the D-70 expects to receive information of any status or data every 500 ms (max.). If the D-70 fails to sense message, it assumes the MIDI bus is disconnected for some reason. Then it mutes all notes that have been turned on by MIDI and returns to normal operation. After that it will not check interval of messages.

Status
FEH

3. EXCLUSIVE COMMUNICATIONS

The D-70 can transmit and receive various parameters through exclusive message in either way described in Section, Roland Exclusive Messages. The following data can be transferred in both ways.

■ Device ID

The actual value of a Device ID is smaller by one than that set to System/Unit #.

■ Model ID

The model ID of D-70 is 39H.

■ Representation of Address/size

Address is used to define a specific location of data. One address consists of 3 MIDI bytes (21 bits): each byte is separated from an adjacent one by a ":", e.g. 00:00:00.

Address ranges from 00:00:00 to 7F:7F:7F, equivalent of 000000 to 1FFFFFF in normal hexadecimal notation.

Address size also has 3 MIDI bytes and is expressed in the same way as address.

■ Transmitted Data

The D-70 will transmit exclusive message as follows:

1) Data transfer mode

* Transmits data selected by panel operation.

2) On receiving Request data (RQ1, RQD)

* Sends parameters reside in the locations corresponding to addresses included in the received RQ1 or RQD (see Data Format for Exclusive Message In Section, Roland Exclusive Messages).

■ Recognized Receive Data

The D-70 is ready to receive exclusive message except the following occasions.

- * During ROM play mode
- * While System/Exclusive Rx is off

■ Type of Messages

● One-way transfer

1) Data request (RQ1)

- * When the received request data contains valid addresses and address size 1 or more, the D-70 sends Data set 1 (DT1) message which contains the requested parameter.
- * The D-70 does not send this message but external device such as sequencer can use.

Byte	Description
FOH	System exclusive status
41H	Manufacturer (Roland) ID
DEV	Device ID 00H-1FH (unit # 1)
39H	Model ID
11H	Command ID (RQ1)
aaH	Address MSB
aaH	Address
aaH	Address LSB
ssH	Size MSB
ssH	Size
ssH	Size LSB
sum	Checksum
F7H	EOX (End of exclusive)

2) Data set (DT1)

* When the received address is valid, the D-70 loads incoming data into the memory location starting with that address.

- * The D-70 sends this message when:
 - A) it has received a Request data (RQ1) and to transfer the size of parameters defined by the RQ1.
 - B) one-way bulk dump is operated in data transfer mode.

Byte	Description
FOH	System exclusive status
41H	Manufacturer (Roland) ID
DEV	Device ID 00H-1FH (unit # 1)
39H	Model ID
12H	Command ID (DT1)
aaH	Address MSB
aaH	Address
aaH	Address LSB
ddH	Data (the number of data allowed to send)
:	
sum	Checksum
F7H	EOX (End of exclusive)

● Handshaking Communications

1) Messages used

1-1) Want to send data (WSD)

This is sent first by the transmitting device.

Byte	Description
FOH	System exclusive status
41H	Manufacturer (Roland) ID
DEV	Device ID 00H-1FH (unit # 1)
39H	Model ID
40H	Command ID (WSD)
aaH	Address MSB
aaH	Address
aaH	Address LSB
ssH	Size MSB
ssH	Size
ssH	Size LSB
sum	Checksum
F7H	EOX (End of exclusive)

1-2) Request data (RQD)

This sent first by receiving device.

Byte	Description
FOH	System exclusive status
41H	Manufacturer (Roland) ID
DEV	Device ID 00H-1FH (unit # 1)
39H	Model ID
41H	Command ID (RQD)
aaH	Address MSB
aaH	Address
aaH	Address LSB
ssH	Size MSB
ssH	Size
ssH	Size LSB
sum	Checksum
F7H	EOX (End of exclusive)

1-3) Data set (DAT)

Actual data block

Byte	Description
FOH	System exclusive status
41H	Manufacturer (Roland) ID
DEV	Device ID 00H-1FH (unit # 1)
39H	Model ID
42H	Command ID (DAT)
aaH	Address MSB
aaH	Address
aaH	Address LSB
ddH	Data (number of data allowed to send)
:	
sum	Checksum
F7H	EOX (End of exclusive)

1-4) Acknowledge (ACK)

A response to the sender to indicate acknowledgement of receipt of a request.

Byte	Description
FOH	System exclusive status
41H	Manufacturer (Roland) ID
DEV	Device ID 00H-1FH (unit # 1)
39H	Model ID
45H	Command ID (ACK)
F7H	EOX (End of exclusive)

1 - 5) End of data (EOD)

Sent to the other party to signal end of communication.

Byte	Description
F0H	System exclusive status
41H	Manufacturer (Roland) ID
DEV	Device ID 00H - 1FH (unit # 1)
39H	Model ID
45H	Command ID (EOD)
F7H	BOX (End of exclusive)

1 - 6) Communication error (ERR)

Sent to the other party to warn occurrence of an error.

Byte	Description
F0H	System exclusive status
41H	Manufacturer (Roland) ID
DEV	Device ID 00H - 1FH (unit # 1)
39H	Model ID
4EH	Command ID (ERR)
F7H	BOX (End of exclusive)

1 - 7) Rejection (RJC)

Sent to refuse the operation required by the other party.

Byte	Description
F0H	System exclusive status
41H	Manufacturer (Roland) ID
DEV	Device ID 00H - 1FH (unit # 1)
39H	Model ID
4FH	Command ID (RJC)
F7H	BOX (End of exclusive)

2) Transfer protocol

* There are three starting methods in handshaking communications.

- A) When bulk dump is selected in data transfer mode on the D-70, it sends a Want to send data to become the sender.
- B) By receiving a Want to send data message from an external D-70 or computer. In this case the local D-70 is the receiver.
- C) By receiving a Request data message from an external device such as computer with the D-70 being the sender.

* The D-70 will not transmit a Data request to become a receiver by itself.

* Below outlines the transfer protocol.

2 - 1) To start communication by the transmitting device (as in the cases A) and B) above.)

Transmitting device	Receiving device
1 : [Want to send data] ---> Starts transfer.	
2a :	<--- [Rejection] Refuses reception if engaged in sound reproduction. Ends transfer upon receiving the Rejection.
2b :	<--- [Acknowledge] If not sounding, sends ACK and waits for data block to be sent.
3 : Data set ---> Sends data.	When address is valid, stores the receive data.
4a :	<--- [Acknowledge] Sends upon storing the data. Transmits the next data set upon receiving the Acknowledge.
4b :	<--- [Communication error] Sends if not correctly received the data and with failed storing. Repeat the same data when receiving the communication error.

(Repeats steps 3 and 4, if necessary.)

5 : [End data] ---> No data follows.	
6 :	<--- [[Acknowledge] Verifies data end before finishing communication. Completes transfer upon receiving Acknowledge.
2 - 2) To start communication by the receiving device (in the cases C) above.)	
Transmitting device (D-70)	Receiving device (external device)
1 :	<--- [Request data] Starts transfer.
2 : [Rejection] ---> Refuses transmission if engaged in sounding.	Stops transfer upon receiving the Rejection.
3 : [Data set] ---> Sends data if free from reproduction, and the address is valid.	External device receives the data and processes to its own program.
4a :	<--- [Acknowledge] Sends when data has been correctly received. Proceeds to the next data set upon receiving the Acknowledge.
4b :	<--- [Communication error] Failed to receive data correctly. Sends the previous data again upon receiving the Communication error (repeats as necessary).
5 : [End data] ---> No following data prepared.	
6 :	<--- [Acknowledge] Verifies data end before finishing communication. Completes transfer upon receiving Acknowledge.

Parameter Address

All the data transferred through exclusive message must be accompanied by the address to identify itself as being for what parameter it represents. An address is represented by the basic address and the offset (amount of shifts). Some parameters have more than one offset. The addresses to be defined by a data set and request data messages must fall in the range specified below.

Names (Tx channel, Performance, Patch and Tone) must be expressed in ASCII code. Codes 0 - 31 are translated into 32 (space) at receiving device.

General table

* The table lists the layout of all of the parameters: any parameter should be found anywhere in the table. Actual address is obtained by adding offset (listed later) to the address in this table.

General table

Address	Size	Contents and remarks	Offset
00:00:00	00:00:08	Internal memory : System setup	Table-1
00:00:08	00:01:20	: Tx channel name	Table-2
00:01:28	00:00:05	Temporary : User set	Table-3
00:01:2D	00:01:71	: Performance	Table-4
00:03:1E	00:00:57	: Part 1 : Patch	Table-5
00:03:75	00:00:57	: Part 2 : Patch	Table-5
00:04:4C	00:00:57	: Part 3 : Patch	Table-5
00:05:23	00:00:57	: Part 4 : Patch	Table-5
00:05:7A	00:00:57	: Part 5 : Patch	Table-5
00:06:51	00:00:3E	: Part 1 : Section 1 : Tone	Table-6
00:07:2F	00:00:3E	: Part 1 : Section 2 : Tone	Table-6
00:07:AD	00:00:3E	: Part 1 : Section 3 : Tone	Table-6
00:08:0B	00:00:3E	: Part 1 : Section 4 : Tone	Table-6
00:08:49	00:00:3E	: Part 2 : Section 1 : Tone	Table-6
00:09:07	00:00:3E	: Part 2 : Section 2 : Tone	Table-6
00:09:45	00:00:3E	: Part 2 : Section 3 : Tone	Table-6
00:0A:03	00:00:3E	: Part 2 : Section 4 : Tone	Table-6
00:0A:41	00:00:3E	: Part 3 : Section 1 : Tone	Table-6
00:0A:7F	00:00:3E	: Part 3 : Section 2 : Tone	Table-6
00:0B:3D	00:00:3E	: Part 3 : Section 3 : Tone	Table-6
00:0B:7B	00:00:3E	: Part 3 : Section 4 : Tone	Table-6
00:0C:39	00:00:3E	: Part 4 : Section 1 : Tone	Table-6
00:0C:77	00:00:3E	: Part 4 : Section 2 : Tone	Table-6
00:0D:35	00:00:3E	: Part 4 : Section 3 : Tone	Table-6
00:0D:73	00:00:3E	: Part 4 : Section 4 : Tone	Table-6
00:0E:31	00:00:3E	: Part 5 : Section 1 : Tone	Table-6
00:0E:6F	00:00:3E	: Part 5 : Section 2 : Tone	Table-6
00:0F:2D	00:00:3E	: Part 5 : Section 3 : Tone	Table-6
00:0F:6B	00:00:3E	: Part 5 : Section 4 : Tone	Table-6
00:10:29	00:14:66	Internal : Rhythm setup	Table-7
00:25:0F	00:00:32	(80:05) : User set	1-1 - 1-10 Table-3
00:25:41	00:78:40	(81:71) : Performance	1-11 - 1-88 Table-4
01:1E:01	00:57:00	(80:57) : Patch	1:A11 - 1:888 Table-5
01:75:01	00:3E:00	(80:3E) : Tone	1:a11 - 1:b88 Table-6
02:33:01	00:14:66	Card : Rhythm setup	Table-7
02:47:67	00:00:32	(80:05) : User set	C-1 - C-10 Table-3
02:48:19	00:78:40	(81:71) : Performance	C-11 - C-88 Table-4
03:40:69	00:57:00	(80:57) : Patch	C:A11 - C:B88 Table-5
04:17:59	00:3E:00	(80:3E) : Tone	C:a11 - C:b88 Table-6
04:55:59	00:02:40	Auxiliary : LCD normal character	Table-8
04:58:19	00:00:50	: LCD big character	Table-9
04:58:69	00:00:01	: User set write request	Table-1
04:58:6A	00:00:01	: Performance write request	Table-1
04:58:6B	00:00:05	: Patch write request	Table-1
04:58:70	00:00:14	: Tone write request	Table-1
04:59:04	00:00:01	: Write result	Table-1

Table 1 System setup

* System setup is to be directly written into the internal memory.

* Exclusive message related parameter when written will be made effective with the next message, if included.

Table - 1. System Setup

Address	Data	Contents and remarks
00:00:00	0 - 127	Master tune (-64 - +63)
00:00:01	0 - 16	Control Channel (1 - 16, Off)
00:00:02	0 - 31	Unit number (1 - 32)
00:00:03	0 - 1	Exclusive RX SW (Off, On)
00:00:04	0 - 1	Hold Pedal Function (Hold, Sostenuto)
00:00:05	0 - 2	Pedal Switch Function (Up, Per. up, Per. down)
00:00:06	0 - 1	MIDI OUT Link mode (Off, On)
00:00:07	0 - 1	Local Switch (Off, On)
00:00:08	(00008H)	Total size

Table 2 Transmission channel name

* To be written directly into the internal memory.

* A channel name must consist of ten characters.

Table - 2. TX Channel Name

Address	Data	Contents and remarks
00:00:00	32 - 127	Channel 1 name (ASCII 10character)
00:00:0A	32 - 127	Channel 2 name (ASCII 10character)
00:00:14	32 - 127	Channel 3 name (ASCII 10character)
00:00:1E	32 - 127	Channel 4 name (ASCII 10character)
00:00:28	32 - 127	Channel 5 name (ASCII 10character)
00:00:32	32 - 127	Channel 6 name (ASCII 10character)
00:00:3C	32 - 127	Channel 7 name (ASCII 10character)
00:00:46	32 - 127	Channel 8 name (ASCII 10character)
00:00:50	32 - 127	Channel 9 name (ASCII 10character)
00:00:5A	32 - 127	Channel 10 name (ASCII 10character)
00:00:64	32 - 127	Channel 11 name (ASCII 10character)
00:00:6E	32 - 127	Channel 12 name (ASCII 10character)
00:00:78	32 - 127	Channel 13 name (ASCII 10character)
00:01:02	32 - 127	Channel 14 name (ASCII 10character)
00:01:0C	32 - 127	Channel 15 name (ASCII 10character)
00:01:16	32 - 127	Channel 16 name (ASCII 10character)
00:01:20	(0000A0H)	Total size

Table 3 User set

Number of user sets prepared: Temporary (1 set), Internal (10 sets) and Card (10 sets)

Table - 3. User Set

Address	Data	Contents and remarks
00:00:00	0 - 127	F.1 Performance (1-11 - C-88)
00:00:01	0 - 127	F.2 Performance (1-11 - C-88)
00:00:02	0 - 127	F.3 Performance (1-11 - C-88)
00:00:03	0 - 127	F.4 Performance (1-11 - C-88)
00:00:04	0 - 127	F.5 Performance (1-11 - C-88)
00:00:05	(000005H)	Total size

● Table 4 Performance

* Number of performance sets prepared: Temporary (1 set), internal (64) and Card (64)
 * For part setting and MIDI OUT section parameters, refer to Table-41 and 42, respectively.

Table-4. Performance

Address	Data	Contents and remarks
00:00:00	32 - 127	Performance name (ASCII character)
00:00:0A	0 - 6	Keyboard Part (1 - 5, R, Off)
00:00:0B	0 - 6	Cl/EXP Pedal - 1 Function (TVF, TVA, LFO pitch, LFO TVF, LFO TVA, Pitch, Porta, time) Destination (Off, Low, Up, Both) Value (0 - 127)
00:00:0C	0 - 3	Destination (Off, Low, Up, Both)
00:00:0D	0 - 127	Value (0 - 127)
00:00:0E	0 - 6	Cl/EXP Pedal - 2 Function (TVF - Porta, time) Destination (Off, Low, Up, Both) Value (0 - 127)
00:00:0F	0 - 3	Destination (Off, Low, Up, Both)
00:00:10	0 - 127	Value (0 - 127)
00:00:11	0 - 3	Pedal switch - 1 Function (Modu, Oct up, Oct down, Effector) Destination (Off, Low, Up, Both)
00:00:12	0 - 3	Destination (Off, Low, Up, Both)
00:00:13	0 - 3	Pedal switch - 2 Function (Modu - Effector) Destination (Off, Low, Up, Both)
00:00:14	0 - 3	Destination (Off, Low, Up, Both)
00:00:15	-----	Part-1 setting <<See Table-41>>
00:00:32	-----	Part-2 setting <<See Table-41>>
00:00:4F	-----	Part-3 setting <<See Table-41>>
00:00:6C	-----	Part-4 setting <<See Table-41>>
00:01:09	-----	Part-5 setting <<See Table-41>>
00:01:26	0 - 16	Part-Rhythm RX Channel (1 - 16, Off)
00:01:27	0 - 127	Output Level (0 - 127)
00:01:28	0 - 127	Zone Lower (C-1 - G9)
00:01:29	0 - 127	Zone Upper (C-1 - G9)
00:01:2A	0 - 1	Assign Priority (Off, On)
00:01:2B	0 - 1	Effect (Off, On)
00:01:2C	0 - 1	MIDI Volume RX SW (Off, On)
00:01:2D	0 - 7	Reverb Type (Room 1 - 3, Hall 1 - 2, Gate, Delay, Cross Delay)
00:01:2E	0 - 31	Delay Time (0 - 31)
00:01:2F	0 - 31	Level (0 - 31)
00:01:30	0 - 31	Feedback (0 - 31)
00:01:31	0 - 4	Chorus Type (Chorus 1 - 2, FB-Chorus, Flanger, Short Delay)
00:01:32	0 - 1	Output Mode (Pre reverb, Post reverb)
00:01:33	0 - 31	Level (0 - 31)
00:01:34	0 - 31	Delay Time (0 - 31)
00:01:35	0 - 31	Rate (0 - 31)
00:01:36	0 - 31	Depth (0 - 31)
00:01:37	0 - 62	Feedback (-31 - +31)
00:01:38	0 - 3	MIDI OUT Velo. Curve (1 - 4)
00:01:39	0 - 127	Velo. Sens (0 - 127)
00:01:3A	0 - 2	Key Mode (Layer, Split, Zone)
00:01:3B	0 - 127	Split Point (C-1 - G9)
00:01:3C	0 - 0	Bender-1 Function (Pitch Bend) Destination (Off, Low, Up, Both)
00:01:3D	0 - 3	Destination (Off, Low, Up, Both)
00:01:3E	0 - 96	Bender-2 Function (C. chg 0-95, A.T.) Destination (Off, Low, Up, Both)
00:01:3F	0 - 3	Destination (Off, Low, Up, Both)
00:01:40	0 - 98	A.T. - 1 Function (C. chg 0-95, A.T., Bend up, Bend down) Destination (Off, Low, Up, Both)
00:01:41	0 - 3	Destination (Off, Low, Up, Both)
00:01:42	0 - 98	A.T. - 2 Function (C. chg 0 - Bend down) Destination (Off, Low, Up, Both)
00:01:43	0 - 3	Destination (Off, Low, Up, Both)
00:01:44	0 - 98	Modulation - 1 Function (C. chg 0 - Bend down) Destination (Off, Low, Up, Both)
00:01:45	0 - 3	Destination (Off, Low, Up, Both)
00:01:46	0 - 98	Modulation - 2 Function (C. chg 0 - Bend down) Destination (Off, Low, Up, Both)
00:01:47	0 - 3	Destination (Off, Low, Up, Both)
00:01:48	0 - 98	Cl/EXP Pedal - 1 Function (C. chg 0 - Bend down) Destination (Off, Low, Up, Both)
00:01:49	0 - 3	Destination (Off, Low, Up, Both)
00:01:4A	0 - 98	Cl/EXP Pedal - 2 Function (C. chg 0 - Bend down) Destination (Off, Low, Up, Both)
00:01:4B	0 - 3	Destination (Off, Low, Up, Both)
00:01:4C	0 - 95	Pedal SW - 1 Function (C. chg 0 - 95) Destination (Off, Low, Up, Both)
00:01:4D	0 - 3	Destination (Off, Low, Up, Both)
00:01:4E	0 - 95	Pedal Sw - 2 Function (C. chg 0 - 95) Destination (Off, Low, Up, Both)
00:01:4F	0 - 3	Destination (Off, Low, Up, Both)
00:01:50	0 - 3	Bold Pedal Destination (Off, Low, Up, Both)
00:01:51	0 - 2	MIDI OUT Lower Velocity mode (Normal, SW, Mix) Threshold sens (0 - 127)
00:01:52	0 - 127	Threshold sens (0 - 127)
00:01:53	0 - 2	MIDI OUT Upper Velocity mode (Normal, SW, Mix) Threshold sens (0 - 127)
00:01:54	0 - 127	Threshold sens (0 - 127)
00:01:55	-----	MIDI OUT Section-1 <<see Table-42>>
00:01:5C	-----	MIDI OUT Section-2 <<see Table-42>>
00:01:63	-----	MIDI OUT Section-3 <<see Table-42>>
00:01:6A	-----	MIDI OUT Section-4 <<see Table-42>>
00:01:71	(0000FH)	Total size

Table-41. Performance part setting

Address	Data	Contents and remarks
00:00:00	0 - 16	RX Channel (1 - 16, Off)
00:00:01	0 - 127	Patch Select (A11 - B88)
00:00:02	0 - 127	Output Level (0 - 127)
00:00:03	0 - 127	Zone Lower Limit (C-1 - G9)
00:00:04	0 - 127	Zone Upper Limit (C-1 - G9)
00:00:05	0 - 1	Assign Priority (Off, On)
00:00:06	0 - 1	Effect (Off, On)
00:00:07	0 - 127	Analog Feel (0 - 127)
00:00:08	0 - 1	MIDI Program RX SW (Off, On)
00:00:09	0 - 1	MIDI Volume RX SW (Off, On)
00:00:0A	0 - 3	Bender - 1 Destination (Off, Low, Up, Both)
00:00:0B	0 - 12	Up depth (0 - +12)
00:00:0C	0 - 48	Down depth (-48 - 0)
00:00:0D	0 - 4	Bender - 2 Function (TVF, TVA, LFO pitch, LFO TVF, LFO TVA) Destination (Off, Low, Up, Both)
00:00:0E	0 - 3	Destination (Off, Low, Up, Both)
00:00:0F	0 - 127	Value (0 - 127)
00:00:10	0 - 5	A.Touch - 1 Function (TVF, TVA, LFO pitch, LFO TVA, LFO TVA, Pitch) Destination (Off, Low, Up, Both)
00:00:11	0 - 3	Destination (Off, Low, Up, Both)
00:00:12	0 - 127	Value (0 - 127)
00:00:13	0 - 5	A.Touch - 2 Function (TVF - Pitch) Destination (Off, Low, Up, Both)
00:00:14	0 - 3	Destination (Off, Low, Up, Both)
00:00:15	0 - 127	Value (0 - 127)
00:00:16	0 - 5	Modulation - 1 Function (TVF - Pitch) Destination (Off, Low, Up, Both)
00:00:17	0 - 3	Destination (Off, Low, Up, Both)
00:00:18	0 - 127	Value (0 - 127)
00:00:19	0 - 5	Modulation - 2 Function (TVF - Pitch) Destination (Off, Low, Up, Both)
00:00:1A	0 - 3	Destination (Off, Low, Up, Both)
00:00:1B	0 - 127	Value (0 - 127)
00:00:1C	0 - 3	Hold 1 Destination (Off, Low, Up, Both)
00:00:1D	(00001DH)	Total size

Table-42. Performance MIDI OUT section

Address	Data	Contents and remarks
00:00:00	0 - 15	MIDI TX Channel (1 - 16)
00:00:01	0 - 127	MIDI Volume (0 - 127)
00:00:02	0 - 127	Program Change Number (1 - 128)
00:00:03	0 - 48	Transpose (-24 - +24)
00:00:04	0 - 127	Zone Lower Limit (C-1 - G9)
00:00:05	0 - 127	Zone Upper Limit (C-1 - G9)
00:00:06	0 - 1	MIDI OUT switch (Off, On)
00:00:07	(00007H)	Total size

● Table 5 Patch

* Number of patches prepared: Temporary (length worth of 6 parts), Internal (128) and Card (128).

Table - 5. Patch

Address	Data	Contents and remarks
00:00:00	32 - 127	Patch name (ASCII 10character)
00:00:0A	0 - 127	Level (0 - 127)
00:00:0B	0 - 3	Velocity Curve (1 - 4)
00:00:0C	0 - 127	Velocity Sens (0 - 127)
00:00:0D	0 - 2	Key Mode (Layer, Split, Zone)
00:00:0E	0 - 127	Split Point (0-1 - 09)
00:00:0F	-----	Lower parameters <<see Table-51>>
00:00:10	-----	Upper parameters <<see Table-51>>
00:00:23	-----	Section 1 parameters <<see Table-52>>
00:00:30	-----	Section 2 parameters <<see Table-52>>
00:00:3D	-----	Section 3 parameters <<see Table-52>>
00:00:4A	-----	Section 4 parameters <<see Table-52>>
00:00:57 (000057H)		Total size

Table - 51. Patch Lower/Upper parameters

Address	Data	Contents and remarks
00:00:00	0 - 2	Velocity Mode (Normal, SW, Mix)
00:00:01	0 - 127	Threshold Sens (0 - 127)
00:00:02	0 - 1	Key Assign (Poly, Solo)
00:00:03	0 - 1	Solo Legato (Off, On)
00:00:04	0 - 1	Portamento switch (Off, On)
00:00:05	0 - 1	Portamento mode (Normal, Auto)
00:00:06	0 - 127	Portamento Time (0 - 127)
00:00:07	0 - 1	MIDI Pan RX SW (Off, On)
00:00:08	0 - 0	<< Reserved >>
00:00:09	0 - 1	MIDI Portamento RX SW (Off, On)
00:00:0A (00000AH)		Total size

Table - 52. Patch Section parameters

Address	Data	Contents and remarks
00:00:00	0 - 127	Tone Select (all - b80)
00:00:01	0 - 127	Level (0 - 127)
00:00:02	0 - 48	Key Shift (-24 - +24)
00:00:03	0 - 127	Fine Tune (-64 - +63)
00:00:04	0 - 127	Cutoff (-64 - +63)
00:00:05	0 - 127	Resonance (-64 - +63)
00:00:06	0 - 127	Attack Time (-64 - +63)
00:00:07	0 - 127	Release Time (-64 - +63)
00:00:08	0 - 3	Output Assign (Dry, Reverb, Chorus, Direct)
00:00:09	0 - 14	Pan (7> - <7)
00:00:0A	0 - 1	Tone switch (Off, On)
00:00:0B	0 - 127	Zone Lower Limit (C-1 - G9)
00:00:0C	0 - 127	Upper Limit (C-1 - G9)
00:00:0D (00000DH)		Total size

● Table 6 Tone

* Number of tones prepared: Temporary (5 part x 4 section), Internal (128) and Card (128).

Table - 6. Tone

Address	Data	Contents and remarks
00:00:00	32 - 127	Tone name (ASCII 10character)
00:00:0A	0 - 66	Original Tone Media (U1 - U32, D1 - D32, (1 - 13) Number (1 - 128)
00:00:0B	0 - 127	
00:00:0C	0 - 1	DLM switch (Off, On)
00:00:0D	0 - 1	mode (Off, On)
00:00:0E	0 - 127	start address (0 - 127)
00:00:0F	0 - 127	loop length (1 - 128)
00:00:10	0 - 96	Pitch Course (-48 - +48)
00:00:11	0 - 127	Fine (-64 - +63)
00:00:12	0 - 15	Pitch Key Follow (-100% - +200%)
00:00:13	0 - 15	Pitch ENV Time KF (-100% - +150%)
00:00:14	0 - 127	A Time (0 - 127)
00:00:15	0 - 34	A depth (-12 - +12)
00:00:16	0 - 127	R Time (0 - 127)
00:00:17	0 - 34	R depth (-12 - +12)
00:00:18	0 - 3	TVP Mode (LFF, BPF, HPF, Bypass)
00:00:19	0 - 127	Cutoff (0 - 127)
00:00:1A	0 - 127	Resonance (0 - 127)
00:00:1B	0 - 3	Velocity Curve (1 - 4)
00:00:1C	0 - 15	Cutoff Key Follow (-100% - +150%)
00:00:1D	0 - 127	ENV Depth (-64 - +63)
00:00:1E	0 - 127	ENV Depth Velo. (0 - 127)
00:00:1F	0 - 15	ENV Time KF (-100% - +150%)
00:00:20	0 - 127	ENV Time Vel. (0 - 127)
00:00:21	0 - 127	ENV Time rel Vel. (0 - 127)
00:00:22	0 - 127	ENV Attack Time (0 - 127)
00:00:23	0 - 127	ENV Attack Level (0 - 127)
00:00:24	0 - 127	ENV Decay 1 Time (0 - 127)
00:00:25	0 - 127	ENV Decay BP (0 - 127)
00:00:26	0 - 127	ENV Decay 2 Time (0 - 127)
00:00:27	0 - 127	ENV Sustain Level (0 - 127)
00:00:28	0 - 127	ENV Release Time (0 - 127)
00:00:29	0 - 127	TVA Level (0 - 127)
00:00:2A	0 - 3	Velocity Curve (1 - 4)
00:00:2B	0 - 127	Velocity Sens (0 - 127)
00:00:2C	0 - 15	ENV Time KF (-100% - +150%)
00:00:2D	0 - 127	ENV Time On Vel. (0 - 127)
00:00:2E	0 - 127	ENV Time Rel Vel. (0 - 127)
00:00:2F	0 - 127	ENV Attack Time (0 - 127)
00:00:30	0 - 127	ENV Attack Level (0 - 127)
00:00:31	0 - 127	ENV Decay 1 Time (0 - 127)
00:00:32	0 - 127	ENV Decay BP (0 - 127)
00:00:33	0 - 127	ENV Decay 2 Time (0 - 127)
00:00:34	0 - 127	ENV Sustain Level (0 - 127)
00:00:35	0 - 127	ENV Release Time (0 - 127)
00:00:36	0 - 4	LFO Waveform (Triangle, Sine, Square, Saw, Random)
00:00:37	0 - 127	Rate (0 - 127)
00:00:38	0 - 15	Delay Time (0 - 15)
00:00:39	0 - 15	Rise Time (0 - 15)
00:00:3A	0 - 4	Offset (-100% - +100%)
00:00:3B	0 - 127	Pitch Mod Depth (-64 - +63)
00:00:3C	0 - 127	TVP Mod Depth (-64 - +63)
00:00:3D	0 - 127	TVA Mod Depth (-64 - +63)
00:00:3E (00003EH)		Total size

● Table 7 Rhythm setup

- * Can be directly written into either internal memory or card.
- * First determine the address of a key and then refer to parameter for that key.

Table - 7. Rhythm Setup

Address	Data	Contents and remarks
00:00:00	0 - 52	Rhythm Shift (-28 - +24)
00:00:01	0 - 0	<< Reserved >>
00:00:02	-----	Key E1 data <<see Table-71>>
00:00:25	-----	Key F1 data <<see Table-71>>
00:00:48	-----	Key F#1 data <<see Table-71>>
00:00:6B	-----	Key G1 data <<see Table-71>>
:	:	:(G#1 .. F7)
00:14:20	-----	Key F#7 data <<see Table-71>>
00:14:43	-----	Key G7 data <<see Table-71>>
00:14:56 (00D66H)		Total size

Table - 71. Rhythm Setup Key parameters

Address	Data	Contents and remarks
00:00:00	0 - 66	Original Tone Media (01 - U32, D1 - D32, 11 - 13)
00:00:01	0 - 127	Number (0 - 127)
00:00:02	0 - 127	Source Key (Off, C#-1 - 09)
00:00:03	0 - 76	Mute (E-1 - G7, Off)
00:00:04	0 - 0	<< Reserved >>
00:00:05	0 - 14	Pan (7> - <7)
00:00:06	0 - 3	Output Assign (Dry, Reverb, Chorus, Direct)
00:00:07	0 - 1	Envelope Mode (Sustain, No sustain)
00:00:08	0 - 24	Pitch Coarse (-12 - +12)
00:00:09	0 - 127	Fine (-64 - +63)
00:00:0A	0 - 127	Pitch ENV A Time (0 - 127)
00:00:0B	0 - 34	A Depth (-12 - +12)
00:00:0C	0 - 3	TVF Mode (LPF, BPF, HPF, Bypass)
00:00:0D	0 - 127	Cutoff (0 - 127)
00:00:0E	0 - 127	Resonance (0 - 127)
00:00:0F	0 - 3	Velocity Curve (1 - 4)
00:00:10	0 - 127	ENV Depth (-64 - +63)
00:00:11	0 - 127	ENV Depth Velo. (0 - 127)
00:00:12	0 - 127	ENV Attack Time (0 - 127)
00:00:13	0 - 127	ENV Attack Level (0 - 127)
00:00:14	0 - 127	ENV Decay 1 Time (0 - 127)
00:00:15	0 - 127	ENV Decay BP (0 - 127)
00:00:16	0 - 127	ENV Decay 2 Time (0 - 127)
00:00:17	0 - 127	ENV Sustain Level (0 - 127)
00:00:18	0 - 127	ENV Release Time (0 - 127)
00:00:19	0 - 127	TVA Level (0 - 127)
00:00:1A	0 - 3	Velocity Curve (1 - 4)
00:00:1B	0 - 127	Velocity Sens (0 - 127)
00:00:1C	0 - 127	ENV Attack Time (0 - 127)
00:00:1D	0 - 127	ENV Attack Level (0 - 127)
00:00:1E	0 - 127	ENV Decay 1 Time (0 - 127)
00:00:1F	0 - 127	ENV Decay BP (0 - 127)
00:00:20	0 - 127	ENV Decay 2 Time (0 - 127)
00:00:21	0 - 127	ENV Sustain Level (0 - 127)
00:00:22	0 - 127	ENV Release Time (0 - 127)
00:00:23 (000023H)		Total size

● Table 8 Full size character for displaying on LCD

- * ASCII code data written into these address are displayed on the LCD as ASCII characters.
- * Accessing to these addresses for data reading will obtain the ASCII codes being displayed on the LCD.
- * Display area is composed of 8 lines x 40 characters.

Table - 8. LCD normal character

Address	Data	Contents and remarks
00:00:00	32 - 127	Top line, left most column (ASCII)
00:00:01	32 - 127	Top line, column 2 (ASCII)
:	:	:
00:02:3F	32 - 127	Bottom line, column 40 (ASCII)
00:02:40 (000140H)		Total size

● Table 9 Double size character for displaying on LCD

- * ASCII code data written into these address locations are displayed on the LCD as ASCII characters having twice dimensions of ordinary counterparts in height and width.
- * Display area is composed of 4 lines x 20 characters.
- * These addresses cannot be accessed for the purpose of reading.

Table - 9. LCD big character

Address	Data	Contents and remarks
00:00:00	32 - 127	Top line, left most column (ASCII)
00:00:01	32 - 127	Top line, column 2 (ASCII)
:	:	:
00:00:4F	32 - 127	Bottom line, column 20 (ASCII)
00:00:50 (000050H)		Total size

● Table 10 User set write request

- * The data written into this address location causes the user set in the temporary area to be transferred and stored into the destination specified by the data.

Table - 10. User set write request

Address	Data	Contents and remarks
00:00:00	0 - 19	Write memory address (1-1 - 1-10, C-1 - C-10)
00:00:01 (000001H)		Total size

● Table 11 Performance write request

- * The data written into this address location causes the performance in the temporary area to be transferred and stored into the destination memory location specified by the data.
- * A message is returned to indicate the result of writing operation.
- * The address cannot be accessed for the purpose of reading.

Table - 11. Performance write request

Address	Data	Contents and remarks
00:00:00	0 - 127	Write memory address (1-11 - 1-88, C-11 - C-88)
00:00:01 (000001H)		Total size

● Table 12 Patch write request

- * The data written into this address location causes the patch in the temporary area to be transferred and stored into the destination memory location specified by the data. The destination is either internal or card.
- * A message is returned to indicate the result of writing operation.
- * The address cannot be accessed for the purpose of reading.

Table - 12. Patch write request

Address	Data	Contents and remarks
00:00:00	0 - 127	Part-1 temporary write address (A-11 - B-88)
00:00:01	0 - 127	Part-2 temporary write address (A-11 - B-88)
00:00:02	0 - 127	Part-3 temporary write address (A-11 - B-88)
00:00:03	0 - 127	Part-4 temporary write address (A-11 - B-88)
00:00:04	0 - 127	Part-5 temporary write address (A-11 - B-88)
00:00:05 (000005H)		Total size

● Table 13 Tone write request

- * The data written into this address location causes the tone in the temporary area to be transferred and stored into the destination memory location specified by the data. The destination is either internal or card.
- * A message is returned to indicate the result of writing operation.
- * The address cannot be accessed for the purpose of reading.

Table - 13. Tone write request

address	Data	Contents and remarks
00:00:00	0 - 127	Part-1 Section-1 write address (a-11 - b-88)
00:00:01	0 - 127	Section-2 write address (a-11 - b-88)
00:00:02	0 - 127	Section-3 write address (a-11 - b-88)
00:00:03	0 - 127	Section-4 write address (a-11 - b-88)
00:00:04	0 - 127	Part-2 Section-1 write address (a-11 - b-88)
00:00:05	0 - 127	Section-2 write address (a-11 - b-88)
00:00:06	0 - 127	Section-3 write address (a-11 - b-88)
00:00:07	0 - 127	Section-4 write address (a-11 - b-88)
00:00:08	0 - 127	Part-3 Section-1 write address (a-11 - b-88)
00:00:09	0 - 127	Section-2 write address (a-11 - b-88)
00:00:0A	0 - 127	Section-3 write address (a-11 - b-88)
00:00:0B	0 - 127	Section-4 write address (a-11 - b-88)
00:00:0C	0 - 127	Part-4 Section-1 write address (a-11 - b-88)
00:00:0D	0 - 127	Section-2 write address (a-11 - b-88)
00:00:0E	0 - 127	Section-3 write address (a-11 - b-88)
00:00:0F	0 - 127	Section-4 write address (a-11 - b-88)
00:00:10	0 - 127	Part-5 Section-1 write address (a-11 - b-88)
00:00:11	0 - 127	Section-2 write address (a-11 - b-88)
00:00:12	0 - 127	Section-3 write address (a-11 - b-88)
00:00:13	0 - 127	Section-4 write address (a-11 - b-88)
00:00:14 (000014H)		Total size

● Table 14 Write result

- * Contains the result of write request which has been written upon request for the result of data write into a particular location, specified in tables 10 to 13.
- * Write and read operation in these locations are inhibited.

Table - 14. Write result

Address	Data	Contents and remarks
00:00:00	0 - 127	Result code
		0 = Complete,
		1 = Protected,
		2 = No card,
		3 = illegal card,
		4 = Write error,
		5 - 126 = Reserved,
		127 = Another error)
00:00:01 (000001H)		Total size

4. PANNIC

When this function is activated, the D-70 tries to recover sound failure (in most of cases sound cannot be turned off) occurring at the remotedevice connected via MIDI.

Pressing the soft button Panic (PLAY and EDIT) causes the D-70 to transmit the following over all 16 MIDI channels. n represents channel.

Note off for all note numbers 8n kk 7F
 Bender = 0 En 00 40
 Channel pressure = 0 Dn 00
 Control change 1 = 0 (Modulation = 0) En 01 00
 64 = 0 (Hold1 = off) En 40 00
 7 = 127 (Volume = 127) En 07 7F

The total message length is 6368 bytes (128 keys x 3 bytes + 14 per channel) To prevent overflow from occurring at the receiver's buffer, data are sent at a half the MIDI transfer rate which will take approx. 4 seconds to complete the transmission.

The D-70 stops active sensing and pauses one second before returning back to normal operating status.

■ How to read a MIDI Implementation Chart

- : MIDI data that can be transmitted or received
- ×: MIDI data that cannot be transmitted or received

● Basic Channel

The MIDI channel for transmitting (receiving) MIDI data can be specified over this range. The MIDI channel setting is remembered even when the power is turned off.

● Mode

Most recent synthesizers use mode 3 (omni off, poly).

Reception: Data is received only on the specified channels, and played polyphonically.

Transmission: All musical data is transmitted on the specified MIDI channel.

* "Mode" refers to MIDI Mode messages.

● Note Number

This is the range of note numbers that can be transmitted (received. Note number 60 is middle C (C4))

● Velocity

This is the range over which velocity can be transmitted (received) by Note On and Note Off messages.

● Aftertouch

Key's: polyphonic aftertouch

Ch's: channel aftertouch

● Pitch Bender

The D - 70 is able to transmit and receive Pitch Bender messages.

● Control Change

This indicates the control numbers that can be transmitted (received), and what they will control. For details, refer to the MIDI implementation.

● Program Change

The program change numbers in the chart indicate the actual data. (This is one less than the Pitch and Tone program numbers.)

● Exclusive

Exclusive message reception can be turned on/off by the exclusive switch (setup).

● Common, Realtime

These MIDI messages are used to synchronize sequencers and rhythm machines. The D - 70 does not use these messages.

● Other

These messages are mainly used to keep a MIDI system running correctly. Active sensing transmission can be turned on/off.

SPECIFICATIONS

D - 70: Super LA Synthesizer

[Keyboard]

76 note (with velocity and channel aftertouch)

[Sound source]

Advanced LA Synthesis

TVF (Time Variant Filters) (Low Pass, High Pass, Band Pass)

Maximum simultaneous notes: 30 voices

[Internal memory]

System Setup: 1

User Set: 10

Performance: 64

Patch: 128

Tone: 128

Rhythm Setup (76 notes: E1 — G7): 1

Original Tone: 119

[RAM Card (M - 256E)]

System Setup: 1

User Set: 10

Performance: 64

Patch: 128

Tone: 128

Rhythm Setup (76 notes: E1 — G7): 1

[Front Panel]

Bender/Modulation lever

Master Volume slider

C1 slider

Brightness slider

Play button

Edit button

PCM Card button

Solo button

Portamento button

Release button

Cutoff button

Resonance button

Attack button

Level button

Pan button

Tuning button

Tone Palette sliders (1 — 4)

Tone/Zone Select buttons (1 — 4)

Tone Display button

MIDI OUT button

EFFECT/CTRL button

Part button

User button

Function buttons (F1 — F5)

Exit button

Cursor buttons

DEC button

INC button

Performance button

Patch button

Tone button

A/B button

INT/CARD button

Command button

Write button

Enter button

Bank buttons (1 — 8)

Number buttons (1 — 8)

Value dial

[Rear panel]

Power switch

RAM Card slot

Protect switch

Contrast knob

MIDI connectors (IN, OUT, THRU)

Control input jacks (Expression Pedal jack, Pedal Switch jack, Hold Pedal jack)

PCM Card slots (A, B)

Direct Output jacks (L/R)

Mix Output jacks (L/R)

Headphone jack

[External dimensions]

1196(W) × 310(D) × 85(H)mm

47 - 1/16" × 12 - 3/16" × 3 - 3/8"

[Weight]

12kg/26 lb 7oz

[Power consumption]

14W

SPECIFICATIONS

【Included items】

Owner's manual

Store All leaflet

Connection cable: PJ - 1 × 1

【Optional items (sold separately)】

RAM Card (memory card): M - 256E

PCM Card (sound library):

SN - SPLA series, SN - U110 series

Stereo headphones: RH - 100

Foot switch:

(latch type) FS - 1, FS - 5L

(unlatch type) FS - 5U, DP - 2, DP - 6

Expression pedal: EV - 5, EV - 10

Keyboard Stand: KS - 5, KS - 7, KS - 8

*Specifications and external appearance are subject to change without notice for product improvement.

INDEX

【A】

Analog Feel	67, 99
Attack Time (Tone Palette)	39, 55, 112
Auto (Portamento Mode)	28, 57, 110

【C】

Channel	
MIDI Palette	68, 104
Part	66, 98
Channel Name	146
Channel Setting (Command)	156, 157, 162
Chorus	
Delay Time	63, 106
Depth	61, 106
Feedback	62, 106
Level	61, 106
Output Mode	62, 106
Rate	61, 106
Type	62, 105
Command	81, 83, 156
Contoroller Map	
KB PRM	64, 96
MIDI OUT	71, 101
Synthe Part	64, 99
Control Channel	35, 49, 137
Copy (Command)	156, 157, 160
Cutoff	
Rhythm Tone	133
Tone	119
Tone Palette	39, 54, 112
Cutoff Key Follow (Tone)	120

【D】

DLM	74, 76, 115, 117
Data Transfer	84, 139, 143, 144
Decimal	46
Delay Time (LFO)	127
Delete	87
Destination (Controller Map)	34, 97, 101, 102
Direct Jump	85
Direction	139
Dump Handshake	141, 143, 145
Dump One Way	141, 143, 145

【E】

EG	74, 82
ENV Depth	
Rhythm TVF	133
Tone TVF	121
ENV Depth Velo Sens	
Rhythm TVF	134
Tone TVF	121
ENV Mode (Rhythm Tone)	131
ENV R Time Velo Sens	
Tone TVA	126
Tone TVF	123
ENV Time KF	
Tone Pitch	116
Tone TVA	125
Tone TVF	122
ENV Time Velo Sens	
Tone TVA	125
Tone TVF	122
Effect (On/Off)	67, 99
End (Command)	146
Envelope	
Time /Depth (Rhythm Pitch)	132
Time /Depth (Tone Pitch)	118
Time /Level (Rhythm TVA)	135
Time /Level (Tone TVA)	126
Time /Level (Tone TVF)	123
Time /Level (Rhythm TVF)	134
Exchange (Command)	156, 157, 160
Exclusive Message	137, 141, 143, 144
Exclusive Rx	137

【F】

Filter Mode	
Rhythm Tone	133
Tone	119
Fine Tune	40, 54, 111
Format (Command)	140
Function (Controller Map)	34, 96, 100, 101

【G】

GBN	46
-----	----

【H】

Hold 138
 Hold Pedal 138

【I】

Initialize (Command) 146, 156, 157, 160
 Insert 87
 Internal 24, 34, 36, 79, 139, 141

【K】

KB Part 32, 35, 67, 96
 Key Assign 28, 53, 56, 109
 Key Mode
 MIDI OUT 30, 69, 103
 Patch 27, 54, 57, 108, 111
 Key Shift 40, 54, 111

【L】

LFO 74
 Latch 33
 Layer
 MIDI OUT Key Mode 30, 69, 103
 Patch Key Mode 27, 54, 57, 108
 Length (DLM) 76, 115, 117
 Level
 Rhythm TVA 134
 Tone Palette 39, 54, 111
 Tone TVA 124
 Local Switch 139

【M】

MIDI OUT 24, 34
 MIDI OUT Link Mode 138
 MIDI Palette 24, 29, 35
 MIDI Volume 39, 69, 104
 MIDI (MIDI Palette) 44, 104
 Master Tune 22, 137
 Memory Area 78
 Mix
 MIDI OUT Velocity Mode 30, 68, 103
 Patch Velocity Mode 27, 56, 108

Mode

 DLM 77, 115, 117
 Data Transfer 141, 143, 145
 Multiple Trigger 109
 Mute (Rhythm Tone) 130

【N】

Name Delete (Command) 156, 158, 166
 Normal
 MIDI OUT Velocity Mode 30, 68, 103
 Patch Velocity Mode 27, 56, 108
 Portamento Mode 28, 57, 110
 Numeric Keypad 47

【O】

Off(Command) 162
 Offset (LFO) 128
 Original Tone Media
 Rhythm Tone 129
 Tone 114
 Original Tone Number
 Rhythm Tone 129
 Tone 114
 Original Tone PRM (Command) 156, 158, 163
 Original Tone 74, 75, 82, 94
 Output Assign
 Rhythm Tone 131
 Tone Palette 26, 43, 53, 60, 63, 112
 Output Level (Part) 39, 58, 66, 98

【P】

PCM 74, 76, 82
 PCM Card 93
 PCM Wave 28, 74, 76
 Pan
 Rhythm Tone 131
 Tone Palette 54, 113
 Pan Rx 110
 Pannic 51, 81
 Part Off (Command) 162
 Part (1—5, R) 24
 Patch 24, 139
 Patch Level 53, 107
 Patch List 45, 90

Patch Name	107
Patch Select	66, 98
Pedal Switch	138
Performance	17, 24, 139
Performance Name	96
Performance list	19, 44, 90
Pitch Coarse	
Rhythm Tone	132
Tone	116
Pitch Fine	
Rhythm Tone	132
Tone	116
Pitch Key Follow (Tone)	116
Pitch Mod Depth	128
Poly	28, 47, 56, 92, 109
Portamento	28, 47, 57, 92, 109
Portamento Mode	28, 57, 110
Portamento Rx	110
Portamento Time	28, 57, 110
Priority	67, 98
Program Change Number	46, 49, 68, 104
Program Change Number List	46
Program Change Number Rx	67, 99

【R】

RAM Card	17, 18, 19, 36, 48, 52, 140
ROM Play	81
Rate (LFO)	127
Release Time (Tone Palette)	39, 55, 112
Resonance	
Rhythm Tone	133
Tone	120
Tone Palette	39, 54, 112
Reverb	
Feedback	60, 105
Level	59, 105
Time	59, 105
Type	59, 105
Rhythm Setup	24, 31, 35, 36, 78, 82
Rhythm Shift	31, 136
Rhythm Tone	82
Rise Time (LFO)	128

【S】

Section L - 1—U - 4	
MIDI Palette	29
Tone Palette	26
Single Trigger	109
Solo	28, 47, 56, 92, 109
Solo Legato	28, 56, 109
Sostenuto	138
Source Key	130
Split	
MIDI OUT Key Mode	30, 69, 103
Patch Key Mode	27, 54, 57, 108
Split Point	
MIDI OUT	30, 69, 103
Patch	27, 54, 57, 108
Start (DLM)	76, 77, 115, 117
Store All (Command)	78, 150, 156, 158, 164
Switch	
MIDI OUT Velocity Mode	30, 68, 103
Patch Velocity Mode	27, 56, 108
Synthe Part	35, 54, 58, 64, 66
System Setup	25, 36, 78

【T】

TVA	74, 82
TVA Mod Depth	128
TVF	74, 82
TVF Mod Depth	128
Temporary Area	78, 144, 150, 157, 158
Tone	24, 36, 139
Tone List	45, 91
Tone Name	114
Tone Palette	24, 26
Tone Select	111
Tone (Tone Palette)	113
Transpose	39, 69, 104
Threshold Sensitivity	
MIDI OUT	30, 68, 103
Patch	27, 56, 108

【U】

Unit Number	137, 141, 143, 144
Unlatch	33
User Set	17, 25, 36, 139

【 V 】

Value (Contoroller Map) 34, 97, 100, 102

Velocity Curve

- MIDI OUT 102
- Patch 107
- Rhythm TVA 135
- Rhythm TVF 133
- Tone TVA 124
- Tone TVF 120

Velocity Mode

- MIDI OUT 30, 68, 103
- Patch 27, 56, 108, 111

Velocity Sensitivity

- MIDI OUT 103
- Patch 107
- Rhythm TVA 135
- Tone TVA 124

Volume Rx 67, 99

【 W 】

WG 74, 76, 82

Waveform(LFO) 127

Write 78, 150

【 Z 】

Zone

- MIDI OUT Key Mode 30, 69, 103
- MIDI Palette 30, 44, 104
- Part 31, 66, 98
- Patch Key Mode 27, 54, 57, 108
- Tone Palette 27, 43, 113

 Roland®

11033

UPC 11033



12991

Roland Corporation

