

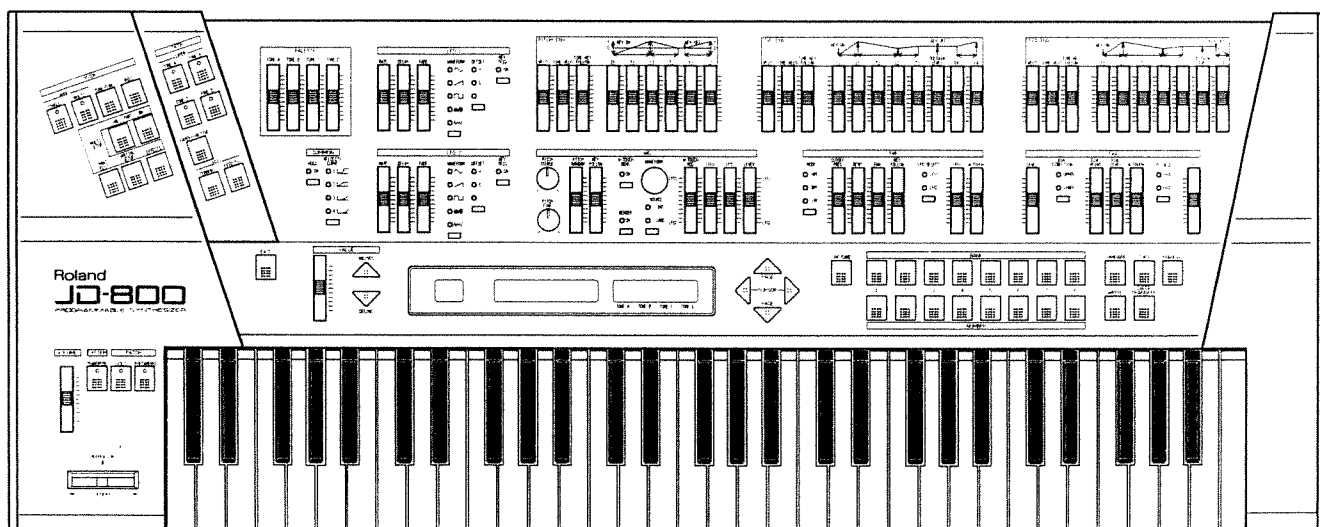

Roland

PROGRAMMABLE SYNTHESIZER

JD-800

Owner's Manual I
(USER'S GUIDE)



	CAUTION RISK OF ELECTRIC SHOCK DO NOT OPEN	
ATTENTION RISQUE DE CHOC ELECTRIQUE NE PAS OUVRIR		
<p>CAUTION: TO REDUCE THE RISK OF ELECTRIC SHOCK, DO NOT REMOVE COVER (OR BACK). NO USER-SERVICEABLE PARTS INSIDE. REFER SERVICING TO QUALIFIED SERVICE PERSONNEL.</p>		



The lightning flash with arrowhead symbol, within an equilateral triangle, is intended to alert the user to the presence of un-insulated "dangerous voltage" within the product's enclosure that may be of sufficient magnitude to constitute a risk of electric shock to persons.



The exclamation point within an equilateral triangle is intended to alert the user to the presence of important operating and maintenance (servicing) instructions in the literature accompanying the product.

INSTRUCTIONS PERTAINING TO A RISK OF FIRE, ELECTRIC SHOCK, OR INJURY TO PERSONS.

IMPORTANT SAFETY INSTRUCTIONS

WARNING — When using electric products, basic precautions should always be followed, including the following:

1. Read all the instructions before using the product.
2. Do not use this product near water — for example, near a bathtub, washbowl, kitchen sink, in a wet basement, or near a swimming pool, or the like.
3. This product should be used only with a cart or stand that is recommended by the manufacturer.
4. This product, either alone or in combination with an amplifier and headphones or speakers, may be capable of producing sound levels that could cause permanent hearing loss. Do not operate for a long period of time at a high volume level or at a level that is uncomfortable. If you experience any hearing loss or ringing in the ears, you should consult an audiologist.
5. The product should be located so that its location or position does not interfere with its proper ventilation.
6. The product should be located away from heat sources such as radiators, heat registers, or other products that produce heat.
7. Avoid using the product where it may be affected by dust.
8. The product should be connected to a power supply only of the type described in the operating instructions or as marked on the product.
9. The power-supply cord of the product should be unplugged from the outlet when left unused for a long period of time.
10. Do not tread on the power-supply cord.
11. Do not pull the cord but hold the plug when unplugging.
12. When setting up with any other instruments, the procedure should be followed in accordance with instruction manual.
13. Care should be taken so that objects do not fall and liquids are not spilled into the enclosure through openings.
14. The product should be serviced by qualified service personnel when:
 - A. The power-supply cord or the plug has been damaged; or
 - B. Objects have fallen, or liquid has been spilled into the product; or
 - C. The product has been exposed to rain; or
 - D. The product does not appear to operate normally or exhibits a marked change in performance; or
 - E. The product has been dropped, or the enclosure damaged.
15. Do not attempt to service the product beyond that described in the user-maintenance instructions. All other servicing should be referred to qualified service personnel.

SAVE THESE INSTRUCTIONS

WARNING: THIS APPARATUS MUST BE EARTHED

For the U.K.

IMPORTANT: THE WIRES IN THIS MAINS LEAD ARE COLOURED IN ACCORDANCE WITH THE FOLLOWING CODE.
GREEN-AND-YELLOW: EARTH, BLUE: NEUTRAL, BROWN: LIVE

As the colours of the wires in the mains lead of this apparatus may not correspond with the coloured markings identifying the terminals in your plug proceed as follows:

The wire which is coloured GREEN-AND-YELLOW must be connected to the terminal in the plug which is marked by the letter E or by the safety earth symbol  or coloured GREEN or GREEN-AND-YELLOW.

The wire which is coloured BLUE must be connected to the terminal which is marked with the letter N or coloured BLACK.

The wire which is coloured BROWN must be connected to the terminal which is marked with the letter L or coloured RED.

The product which is equipped with a THREE WIRE GROUNDING TYPE AC PLUG must be grounded.

Roland JD - 800

Programmable Synthesizer

Owner's Manual I
(User's Guide)

Thank you for purchasing the Roland JD-800 Programmable Synthesizer.

The JD-800 is a state-of-the-art digital synthesizer specially designed to enhance one of the most enjoyable aspects of synthesis; the fun of creating your own sounds. In order to take full advantage of the JD-800's sound quality and functionality, and to enjoy long and trouble-free service, please read this manual carefully.

We hope that you will find the JD-800 to be a powerful sound-creation tool in both recording and performance situations.

©Copyright 1991 by ROLAND CORPORATION

All rights reserved. No part of this publication may be reproduced in any form without the permission of ROLAND CORPORATION.

How to use this manual

The manual is divided in two parts.

Owner's Manual I (User's Guide)

Owner's Manual II (Reference)

This manual (User's Guide) explains the essential operations and functions that you will need to know in order to use the JD-800. Whether this is your first synthesizer, or you have used synthesizers before, please be sure to read the necessary sections.

When you want to learn about the JD-800 in greater detail, read through this manual, and then refer to the Owner's Manual II (Reference).

The following table shows the main topics covered in the User's Guide. Read each section as necessary.

	If this is your first synthesizer	If you have used synthesizers before
I What is the JD-800 ?	○	×
II Basic procedure	○	△
III How to modify sounds	○	△
IV Using the performance	○	△
V About MIDI	△	△





○ be sure to read this section

△ read this section when necessary

× there is no need to read this section

Conventions used in this manual

In order to present information as clearly as possible, the following conventions are used in this manual. If you come across a symbol you don't understand, refer back to this page.

- Words printed in inverse **VALUE** refer to front panel sliders. For example, **VALUE** indicates the VALUE slider. Boxed words **SOLO** refer to front panel buttons. For example, **SOLO** refers to the solo button.
- CURSOR   and PAGE   mean that you should press one or the other button.
- An asterisk " * " at the beginning of a line indicates a comment or note.
- ( II P.**) indicates a page reference. " II " indicates the Owner's Manual II (Reference).

MAIN FEATURES

The JD-800 is a digital synthesizer that uses leading-edge digital technology in conjunction with Roland's analog synthesizer expertise. Some of its main features are as follows.

High-quality sound source

The JD-800 uses a PCM sound source which contains 108 different types of PCM waveforms including sawtooth waves, pulse waves, noise waveforms, one-shot waveforms, and looped waveforms.

Additional waveforms can be loaded from a WAVEFORM card (SO-JD80 series; separately sold). Furthermore, these PCM waveforms can be processed by filters to provide an extremely wide variety of sound-creation possibilities.

Front panel design for intuitive sound creation

The JD-800 provides front panel controls for all basic Tone parameters, bringing an analog type interface to a digital synthesizer. Since parameter controls are arranged in the order of signal flow, the sound shaping process is easy to understand. You can also adjust the sound parameters in realtime as you perform.

On-board effects processor

The JD-800 has an on-board DSP (Digital Signal Processor) that provides a wide variety of effects.

In Single mode, you have eight different digital effects; a three-band equalizer for each Patch, and also distortion, enhancer, phaser, spectrum, delay, chorus, and reverb.

In Multi mode, you have four different digital effects; a three-band equalizer for each Patch, and also chorus, delay, and reverb. You can specify how the effect will be applied to each of the five Parts and the Special Part.

Two play modes ; Single and Multi

The JD-800 has two play modes; Single and Multi.

In Single mode, the entire JD-800 plays a single Patch. This mode is appropriate when you are playing solo parts.

In Multi mode, the JD-800 functions as a multi-timbral sound source with five Synth Parts and a Special Part. When used with a sequencer or MTR, this mode allows the JD-800 to simultaneously play all the parts of an ensemble.

External expansion

The JD-800 has two card slots; DATA card (M-256E, sold separately) and WAVEFORM card (SO-JD80 series, sold separately).

When a DATA card is inserted, you can select from a total of 128 Patches, including the 64 internal Patches.

If a WAVEFORM card is used, you can also create sounds using PCM waveforms from the card.

TABLE OF CONTENTS

IMPORTANT NOTES	8
PANEL DESCRIPTION	9

Chapter I What is the JD-800?

1. THE JD-800 PHILOSOPHY	I -2
The origin of the JD-800	I -2
2. HOW THE JD-800 IS ORGANIZED	I -3
● Basic procedures	I -3

Chapter II Basic procedure

1. PREPARATIONS	II -2
● Make connections	II -2
● Turn the power on/off	II -4
○ How to turn the power on	II -4
○ How to turn the power off	II -5
2. HEAR THE DEMO SONG	II -6
3. SELECT SOUNDS AND PLAY	II -8
a. Single mode	II -8
● How to select a Patch	II -8
b. Multi mode	II -9
● How to select the Part	II -9
● How to select a Patch for a Part	II -12

Chapter III How to modify sounds

1. PATCH EDITING	III -2
a. Before you begin editing	III -2
● How a Patch is organized	III -3
● How a Tone is organized	III -4
b. Tone editing procedure	III -5
● Select a Tone	III -5
● Change the waveform	III -6
● Modify the tone color	III -8
● Modify the volume change	III -10
● Add vibrato	III -12
● Adjust the volume balance	III -14

c. Patch editing	III -16
● Name the Patch	III -16
● Make equalizer settings	III -17
● Make effect settings	III -18
d. When you finish editing	III -23
● To recover the original sound	III -23
● To store your edited sound	III -24
2. SPECIAL SETUP EDIT	III -25
a. Before you edit	III -25
● How a Special Setup is organized	III -25
b. Editing procedure	III -26
● Modify the settings for individual keys	III -26
● Modify the Equalizer settings	III -27
● Modify the Common settings	III -28
c. When you finish editing	III -29
● To recover the original sound	III -29
● To store your edited sound	III -30
3. LEARNING TO CREATE SOUNDS	III -31
a. What is sound?	III -31
● The basics of sound	III -31
● Adding expression	III -36
b. Sound creating procedure	III -41
● How sound is created (understand sound generation)	III -41
● Sound creation procedure	III -42
● Ideas for sound creation	III -45

Chapter IV Using the performance functions

1. TUNING ADJUSTMENT	IV -2
2. KEYBOARD-RELATED SETTINGS	IV -3
● Velocity	IV -3
● Aftertouch	IV -3
● Transpose	IV -4
3. NON-KEYBOARD CONTROLS	IV -5
● Bender/Modulation lever	IV -5
● Hold pedal	IV -6
● External control	IV -7

4. PLAY IN SOLO MODE	IV -8
● Solo	IV -8
● Portamento	IV -9
5. MODIFY THE SOUND WHILE PLAYING	IV -10
● Realtime editing	IV -10
6. HOW TO USE A DATA CARD	IV -11
● Inserting a data card	IV -11
● Initializing a data card	IV -12
● Using a data card	IV -13

Index

Index	Index2
-------------	--------

Chapter V About MIDI

1. WHAT IS MIDI?	V -2
● MIDI connections	V -2
● MIDI channels	V -4
2. MIDI MESSAGES	V -5
a. Channel messages	V -6
● Voice messages	V -6
● Mode messages	V -8
b. System messages	V -11
● Realtime messages	V -11
● Common messages	V -11
● Exclusive messages	V -11
3. TAKING ADVANTAGE OF MIDI	V -13
a. Using MIDI in Single mode	V -13
● Connecting an external sound module	V -14
● Using the JD-800 with a sequencer	V -16
b. Using MIDI in Multi mode	V -17
● Using the JD-800 with a sequencer	V -18
● Connecting an external sound module	V -20
c. Exchanging data via Exclusive messages	V -22
● Patch Dump	V -23
● Bulk Dump	V -24
● Editing data transmission	V -25
4. MIDI SETTINGS	V -26
● MIDI channel	V -26
● Local Control	V -32
● Exclusive message reception	V -33

I

II

III

IV

V

INDEX

IMPORTANT NOTES

In addition to the items listed under Safety Precautions on page 2, please read and adhere to the following:

【Power Supply】

- When making any connections with other devices, always turn off the power to all equipment first; this will help prevent damage or malfunction.
- Do not use this unit on the same power circuit with any device that will generate line noise, such as a motor or variable lighting system.

【Placement】

- Using the unit near power amplifiers (or other equipment containing large transformers) may induce hum.
- This unit may interfere with radio and television reception. Do not use this unit in the vicinity of such receivers.

【Maintenance】

- For everyday cleaning wipe the unit with a soft, dry cloth (or one that has been slightly dampened with water). To remove stubborn dirt, use a mild neutral detergent. Afterwards, be sure to wipe the unit thoroughly with a soft, dry cloth.
- Never use benzene, thinners, alcohol or solvents of any kind, to avoid the risk of discoloration and/or deformation.

【Additional Precautions】

- Protect the unit from strong impact.
- Never strike or apply strong pressure to the display.

- A small amount of heat will radiate from the unit, and thus should be considered normal.
- Before using the unit in a foreign country, consult with qualified service personnel.
- A small amount of noise may be heard from the display, and thus should be considered normal.

【Memory Backup】

- The unit contains a battery which maintains the contents of memory while the main power is off. The expected life of this battery is 5 years or more. However, to avoid the unexpected loss of memory data, it is strongly recommended that you change the battery every 5 years.
Please be aware that the actual life of the battery will depend on the physical environment (especially temperature) in which the unit is used. When it is time to change the battery, consult with qualified service personnel.
- When the battery becomes weak the following message will appear in the display: "Internal battery low". However, by that time the contents of memory may have already been lost.
- Please be aware that the contents of memory may at times be lost; when the unit is sent for repairs or when by some chance a malfunction has occurred. Important data should be stored on a DATA card or in another MIDI device (eg. a sequencer), or written down on paper. During repairs, due care is taken to avoid the loss of data. However, in certain cases, (such as when circuitry related to memory itself is out of order) we regret that it may be impossible to restore the data.

PANEL DESCRIPTION

Front panel

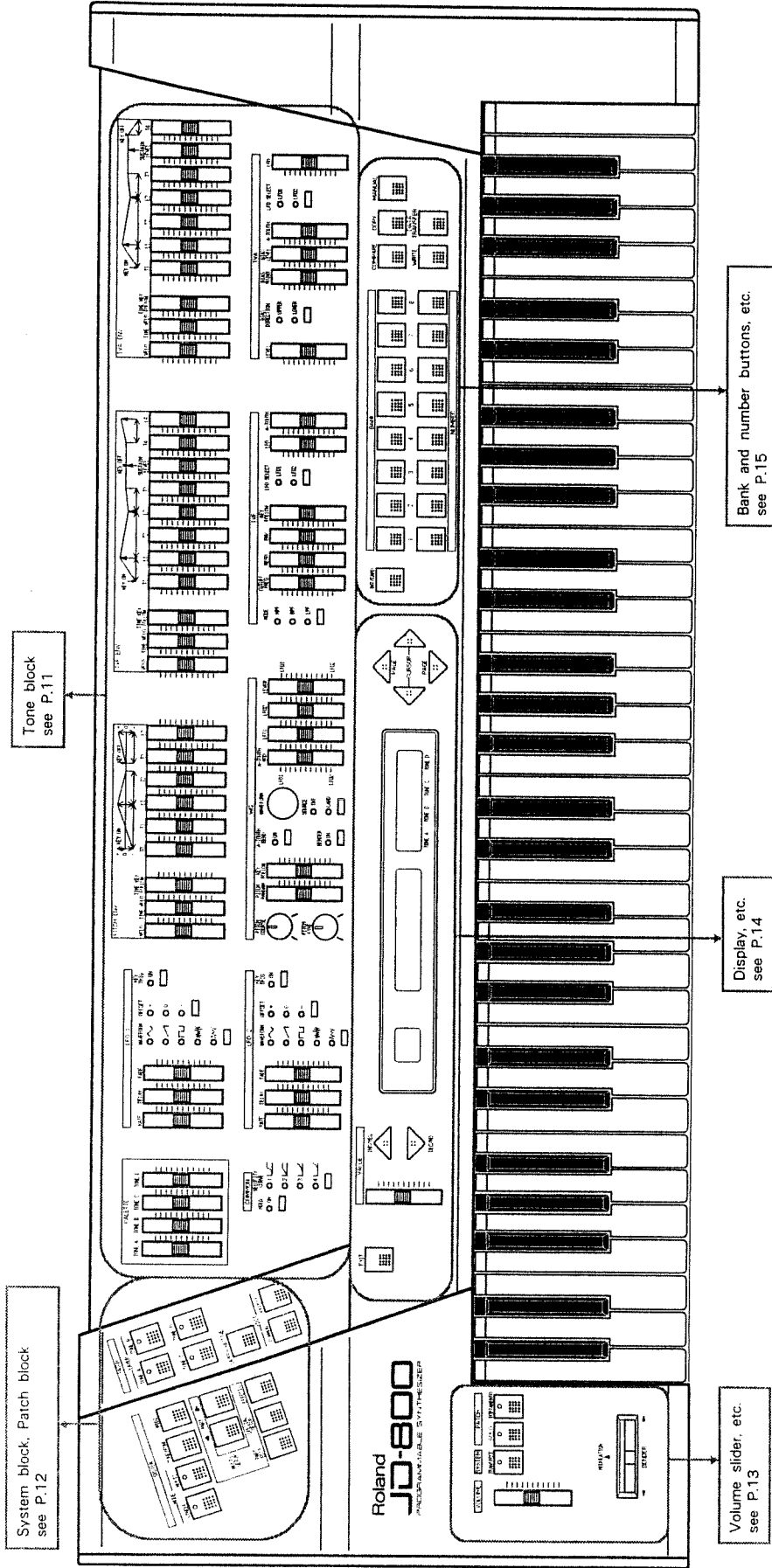

PANEL DESCRIPTION

Rear panel

Power switch [POWER]
This switch turns the power on/off.

AC inlet [AC]
Connect the included power cable here. Connect the cable to an AC outlet of the correct voltage for your unit.

Hold pedal jack [HOLD PEDAL]

A pedal switch (unlatched type : FS-5U, DP-2 ; sold separately) can be connected to this jack and used as a damper (hold) pedal.

External control jack [EXT CONT]

An expression pedal (EV-5, EV-10 ; sold separately) can be connected here. Depending on the jack settings, the pedal will control Volume, Modulation, Pan, or Aftertouch.

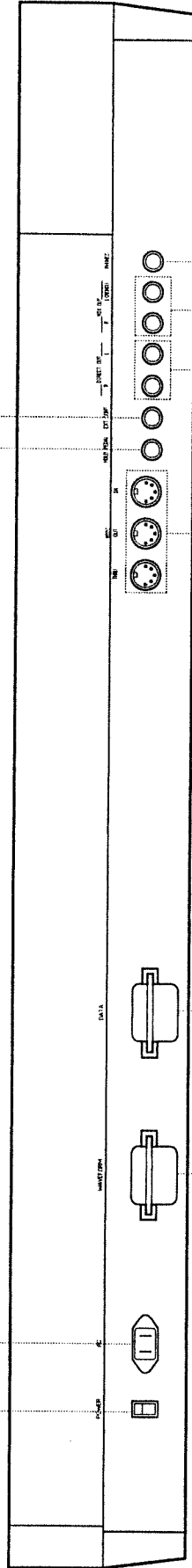

WAVEFORM card slot [WAVEFORM]
A WAVEFORM card (SO-JD80 series ; sold separately) containing PCM waveforms can be inserted here.

DATA card slot [DATA]
A DATA card (M-256E ; sold separately) can be inserted here to store Patch and other data.

MIDI connectors [MIDI IN/OUT/THRU]
MIDI cables can be connected to these jacks, allowing the JP-800 to communicate with other MIDI devices.

Headphone jack [PHONES]
A pair of stereo headphones (RH-12/100 ; sold separately) can be connected here. The headphone volume is adjusted by the front panel volume slider. Sound will be output from the output jacks even if headphones are connected to this jack. If you will be using your own headphones, make sure the impedance is 8-150 ohms.

Mix Out jacks [MIX OUT L (MONO) /R]
Connect an external mixer/amp system to these stereo output jacks. They will output the sound processed by the internal effects combined with the direct sound. You will normally use these jacks for output. Use only the L (MONO) jack for monaural applications.

Direct Out jacks [DIRECT OUT L/R]
These stereo output jacks are used only in Multi mode. They will output the direct sound of the instrument (sound not processed by the effects unit). Use these jacks when using external effects devices to process the sound. In Single mode, sound will not be output from these jacks. If no connections are made to these jacks, the direct sound will be output from the Mix Out jacks.

Tone block

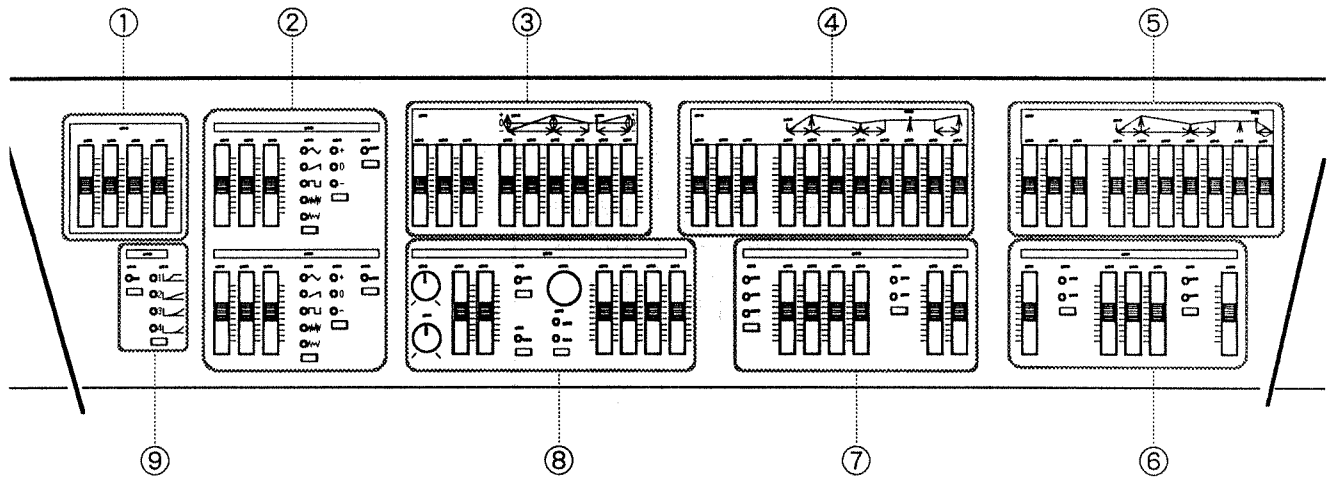

① Palette [PALETTE]

These sliders let you adjust the currently-selected parameter for all four Tones at once. When a Patch is selected, these sliders will be assigned to TVA levels.

② LFO section [LFO1/2]

The LFO parameters let you create effects such as vibrato, wah-wah, and tremolo. LFO1 and LFO2 can be set independently.

③ Pitch envelope section [PITCH ENV]

Specifies how the pitch will change over time.

④ TVF envelope section [TVF ENV]

Specifies how the tone will change over time.

⑤ TVA envelope section [TVA ENV]

Specifies how the volume will change over time.

⑥ TVA section [TVA]

Specifies the volume.

⑦ TVF section [TVF]

Selects a filter and adjusts the tone.

⑧ WG section [WG]

Selects the basic waveform, and specifies the pitch.

⑨ Common buttons [COMMON]

Selects the velocity curve that will apply to the entire Tone, and turns the Hold effect on/off.

System block, Common block

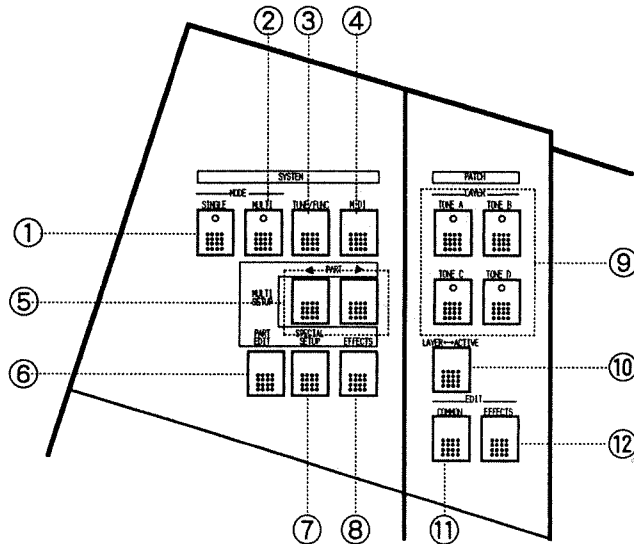

① Single button **SINGLE**

Press this button to select Single mode.

② Multi button **MULTI**

Press this button to select Multi mode.

③ Tune/Function button **TUNE/FUNC**

Press this button to make settings that affect the entire JD-800, such as overall tuning, transposition, external control, and mix out filter.

④ MIDI button **MIDI**

Press this button to make MIDI-related settings.

⑤ Part buttons **◀PART▶**

When using the JD-800 in Multi mode, press these buttons to select Parts.

⑥ Part edit button **PART EDIT**

When using the JD-800 in Multi mode, press this button to set Part parameters.

⑦ Special Setup button **SPECIAL SETUP**

When using the JD-800 in Multi mode, press this button to make Setup parameter settings.

⑧ Effects button **EFFECTS**

When using the JD-800 in Multi mode, press this button to make Effect parameter settings.

⑨ Layer buttons **LAYER TONE A — TONE D**

Use these buttons to turn the Tones of the Patch on/off, or to select the Active Tone(s). The button indicators will light to indicate Tones that are sounding.

⑩ Layer/Active button **LAYER↔ACTIVE**

Press this button to view and set Layer on/off or Active on/off for the four buttons **TONE A — TONE D**. When setting Layer on/off, the indicators of the four Layer buttons will be either lit or unlit. When setting Active on/off, the indicators of the four Layer buttons will be either blinking or unlit.

⑪ Edit Common button **EDIT COMMON**

Press this button to set Common parameters for a Patch.

⑫ Edit Effects button **EDIT EFFECTS**

In Single mode, press this button to set Effect parameters for a Patch.

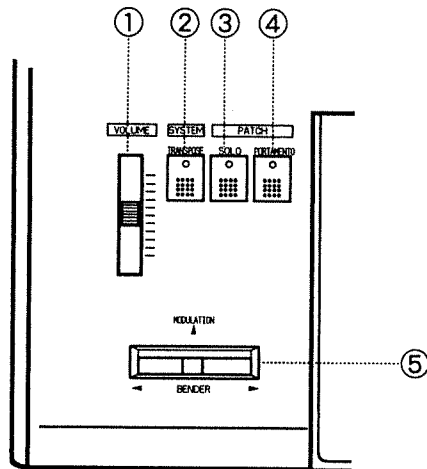
Volume slider, etc.

① Volume slider **VOLUME**

This slider adjusts the volume of the Mix Out jacks and the headphones. It has no effect on the volume of the Direct Out jacks.

② Transpose button **TRANPOSE**

Press this button to transpose keyboard pitch.

③ Solo button **SOLO**

Press this button to make the indicator light, and you can play the JD-800 like a monophonic synthesizer.

④ Portamento button **PORTAMENTO**

While the Solo button is lit, press this button to apply a portamento effect (smooth pitch change between notes).

⑤ Bender/Modulation lever
[BENDER/MODULATION]

Use this lever to bend the pitch, or to apply vibrato.

Display, etc.

Display, etc.

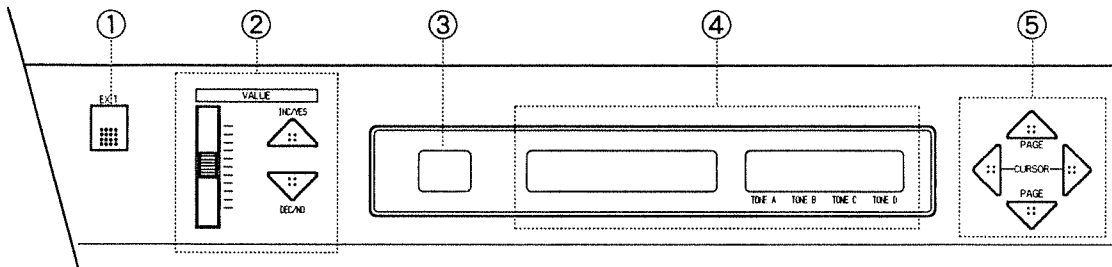

① Exit button EXIT

Press this button to return to Play mode from Data Transfer, ROM Play, or from an editing or writing operation.

② Value slider VALUE, INC/YES button INC/YES, DEC/NO button DEC/NO

Use these controls to modify the values of parameters (other than Tone parameters). The parameter value will increase by 1 each time you press the INC/YES button, and decrease by 1 each time you press DEC/NO.

The value slider is convenient when you want to make major changes in a value. The INC/YES/DEC/NO buttons are also used to reply to messages that request you to confirm an operation.

* These buttons and the value slider cannot be used to modify Tone parameters.

③ LED display

This indicates the number (bank and number) of the currently selected Patch. While editing the Patch, dot (.) is lit.

④ LCD display

Depending on the situation, the left display shows Patch and System-related information, and the right display shows Tone-related information.

⑤ Page buttons PAGE ▲ ▼

While playing, use these buttons to select the Tone parameter you wish to check. While editing (other than Tone parameters), use these buttons to select parameters.

⑤ Cursor buttons CURSOR ◀ ▶

While editing or entering a Patch name, etc., use these buttons to move the cursor (the blinking character) to the left or right.

Bank/Number buttons, etc.

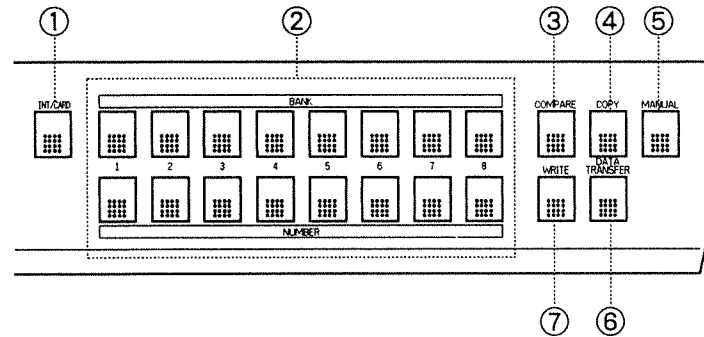

① Internal/Card button **INT/CARD**

Press this button to switch between internal Patches/Setup (INT) or DATA card Patches/Setup (CARD).

② Bank/Number buttons **BANK 1—8**, **NUMBER 1—8**

Press these buttons to select one of the sixty-four Patches; 11—88.

③ Compare button **COMPARE**

If you press and hold this button while playing, the original parameter values of the Patch will be displayed in the right LCD.

By pressing this button during a Write operation, you can check the sound of the writing destination Patch.

④ Copy button **COPY**

Press this button to copy parameters of Patch or Special Setup.

⑤ Manual button **MANUAL**

Press this button to set the temporary Tone to match the current panel settings (the position of all panel controls).

⑥ Write button **WRITE**

Press this button to store an edited Patch or Special Setup into internal or card memory.

⑦ Data Transfer button **DATA TRANSFER**

Press this button to transfer data between the JD-800 and external devices, or to restore the factory settings.

【MEMO】

Chapter I**What is the JD-800 ?**

The JD-800 has a large number of functions. However, simply listing and explaining each function and operation could be more confusing than helpful. Therefore, this chapter will look at the features and structure of the JD-800 in order to give you a general overview.

1. THE JD-800 PHILOSOPHY

The origin of the JD-800

In the days before electricity, musicians had only acoustic instruments as a means of making music and sound. When electricity became available, musicians had a way to make those acoustic sounds louder. Later, electricity was used to record and reproduce acoustic sounds. Later still, the “synthesizer” was developed. “Synthesizers” were originally developed as a way of “synthesizing” or making sound. Over time, however, synthesizers came to be used as distinct musical instruments that allowed for the creation of unique sounds.

In the past, all synthesizers were of the analog type. Those synthesizers had lots of knobs; one knob for each function. This meant that the process of making sounds was a visual and fairly intuitive process. These synthesizers emphasized the process of sound creation.

As digital technology advanced, digital synthesizers appeared. These synthesizers were able to simulate acoustic instrument sounds that analog machines could not. Overall, digital instruments offered a wider variety of possibilities, but with one major tradeoff: sound creation became much more complicated.

Today, fewer and fewer people actually create their own sounds, and simply play presets or sounds created by programmers.

However, the original purpose of the synthesizer was to “create sound”. It’s easy to simply select a preset you like, but that sound will always be “someone else’s sound”. We at Roland asked, “Why don’t we return to the roots of synthesis; the enjoyment of creating original sounds?” We considered many different ways in which we could bring back the fun of creating sounds, and the result is the JD-800 before you.

“Creating sounds” may seem like a highly technical process, but it’s actually just a matter of moving a slider to make the sound change! This is easy for anyone, and the sounds that you get will always be your very own.

The JD-800 is designed to make it fun to create sounds. So please go ahead and move those sliders! We hope you will make lots of different sounds; original sounds with which to play your original music.

2. HOW THE JD-800 IS ORGANIZED

Next, we will talk about how the JD-800 is organized. First we will explain basic procedures, and how Single mode and Multi mode are organized.

● Basic procedures

To enter the various modes, press the appropriate button. To leave that mode (operation), press **EXIT**.

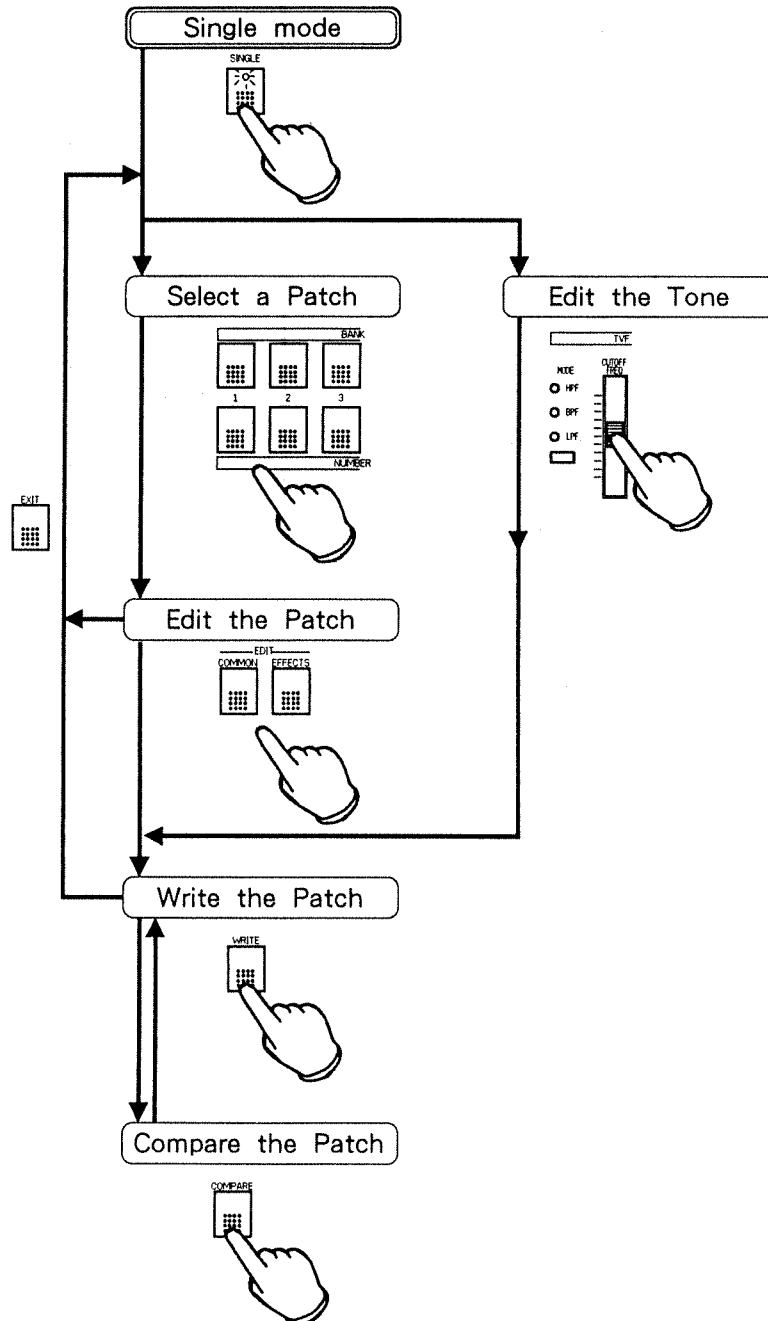

2. HOW THE JD-800 IS ORGANIZED

Procedure in Multi mode

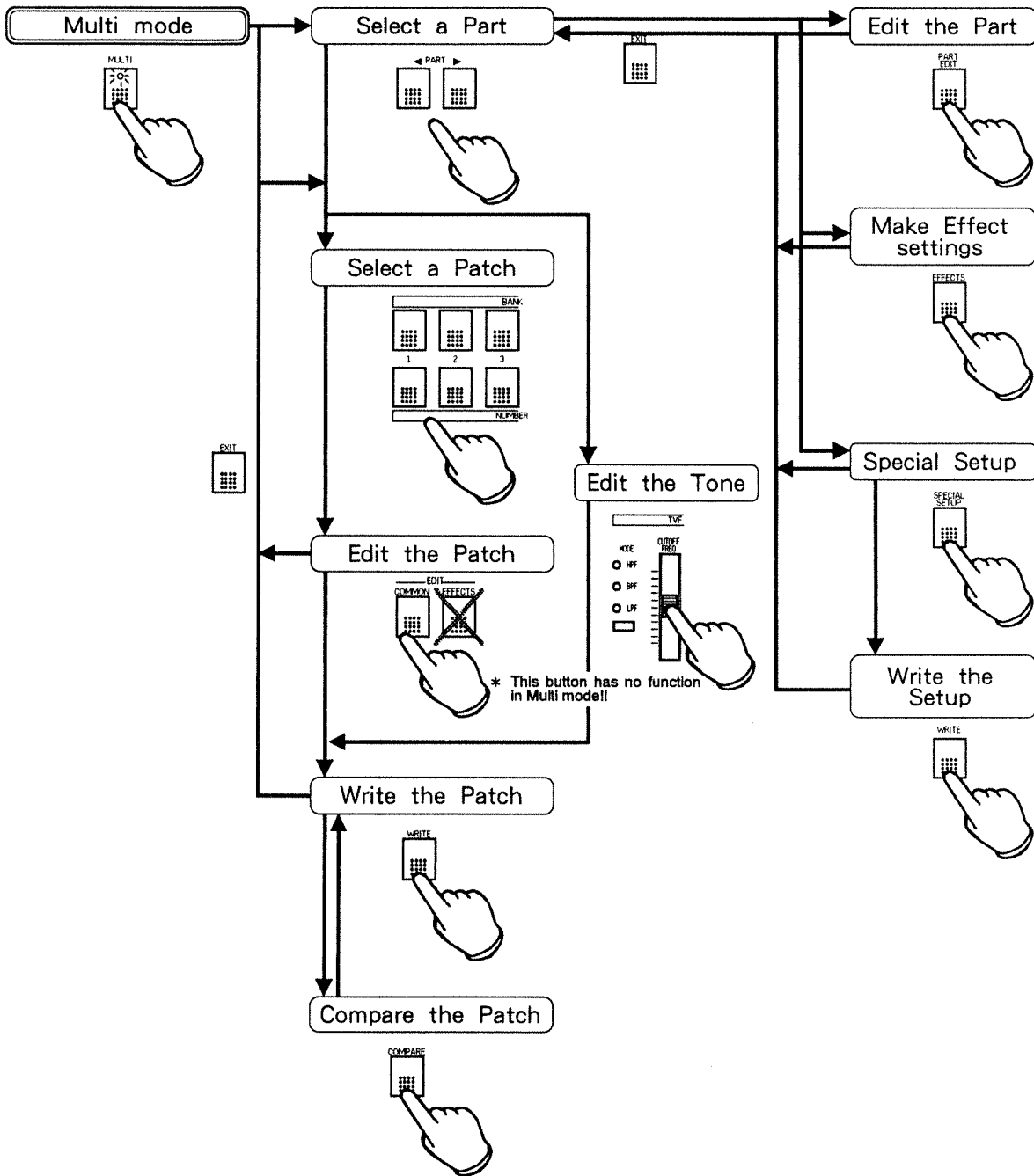

- **Single mode** In Single mode, you play one Patch at a time. A Patch consists of four Tones, which then pass through the common EQ, and then through the effects unit. The diagram below shows the signal flow from note-on to sound output. For details of the data in a Patch, refer to “How a Patch is organized” (⇐ P. III – 3).

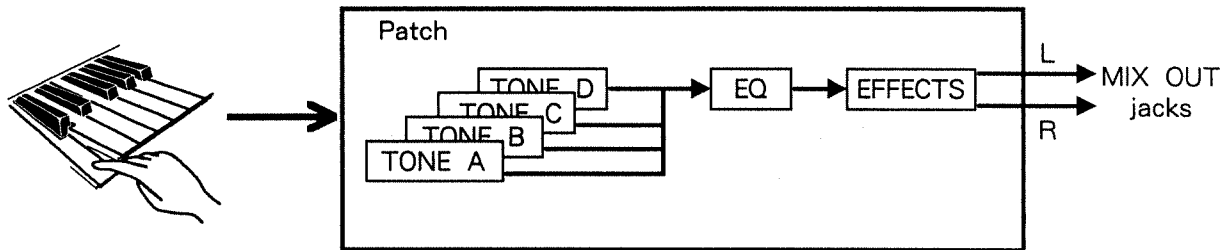

2. HOW THE JD-800 IS ORGANIZED

Structure of Multi mode

○ **Multi mode** In Multi mode, the JD-800 will play five Synth Parts (Patches) and a Special Part (Setup). However, the same effect is used for all Parts.

For each Part, you can set level and pan of the assigned Patch, set the output assign / effect mode and effect level (to determine how much effect is applied).

The Special Part uses a Tone for each key, and you can set pan, effect mode and effect level for each key.

The diagram below shows the signal flow from note-on to sound output.

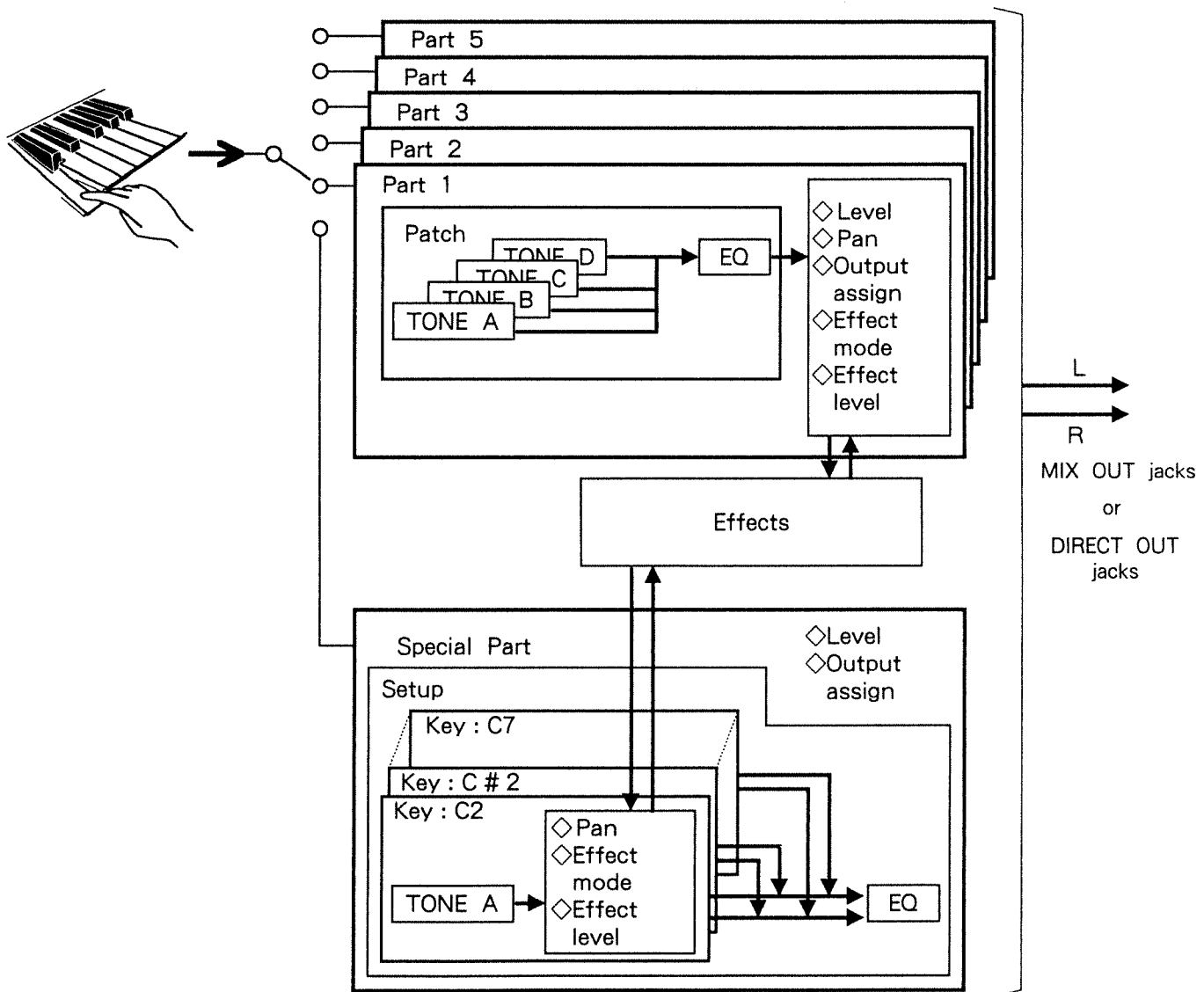

○ Memory

“Memory” is where you store Patches and other types of data. The JD-800 uses two types of memory; internal memory (INT) and DATA card (CARD) memory. The diagram below shows how internal memory and DATA card memory is organized.

When you select a Patch, the data is first copied into a “temporary” area, and this data is then used to produce sounds. Edits you make affect this data in the temporary area.

Data in the temporary area will be lost when you turn the power off, but data in memory will be preserved, and can be recalled at any time.

*** You can use Patches from internal memory and from a card simultaneously, but not in a Special Setup.**

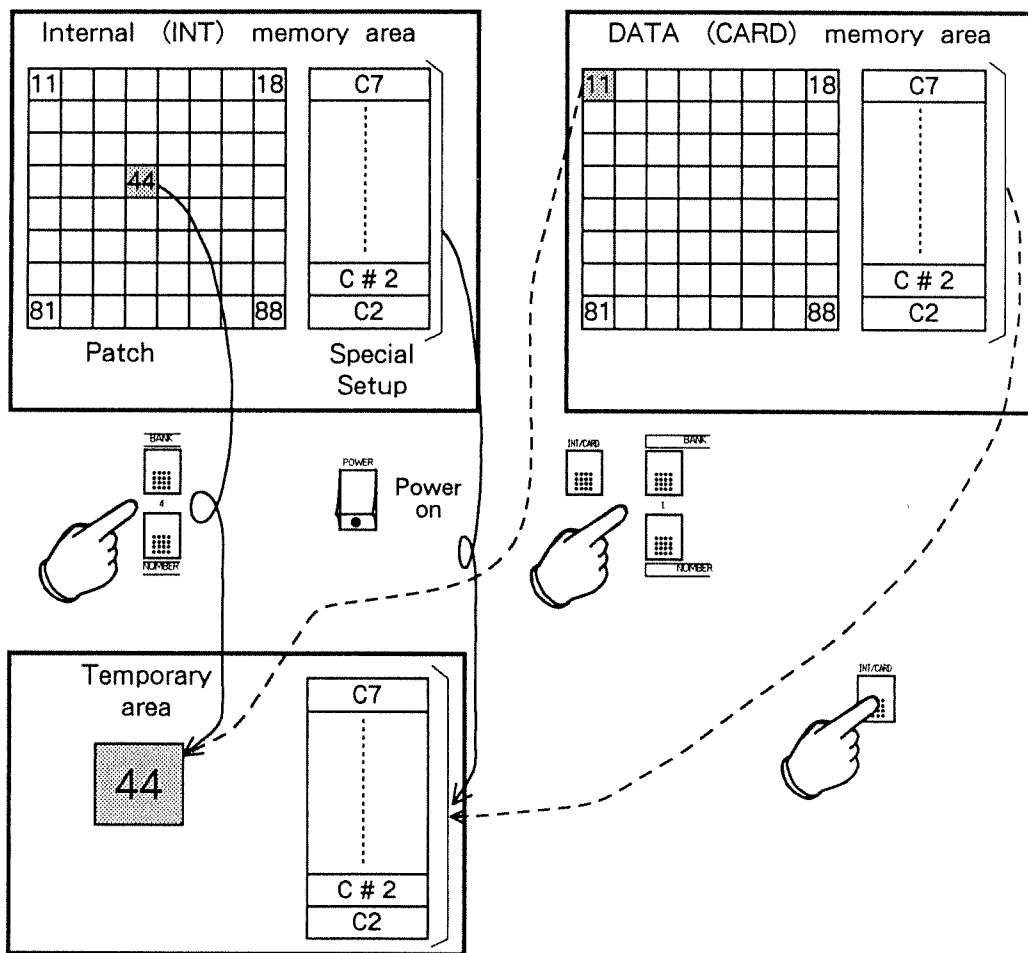

【MEMO】

Basic procedure

Now we will explain the basic procedures you will need to know in order to use the JD-800.

1. PREPARATIONS

Here's how to set up and play the JD-800.

● Make connections

The JD-800 does not contain an amp or speakers. Unless you are using headphones, you will need an external amplification system, such as a radio-cassette unit, stereo set, or keyboard amplifier.

JD - 800

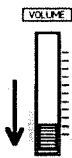

Set the volume to 0!



Turn the power off!

External amplification system

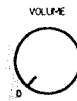

Set the volume to 0!



Turn the power off!

*** Before you make connections, check the following two points. Failing to do so may result in damage to your amp or speaker system.**

- Is the power turned off to both the JD-800 and the amp?
- Is the volume turned to minimum for both the JD-800 and the amp?

Connection with external amplification systems

The included cable can be used as it is to connect the JD-800 to a keyboard amp, etc., or you can remove the plug adaptor to connect the JD-800 to the RCA jack AUX IN or LINE IN input of a stereo set, etc.

In order to take full advantage of the JD-800, we suggest that you use stereo output. If this is not possible, use only the L (MONO) MIX OUT jack. The DIRECT OUT jacks are used only in Multi mode. When the JD-800 is used in Single mode, there will be no sound from the DIRECT OUT jacks.

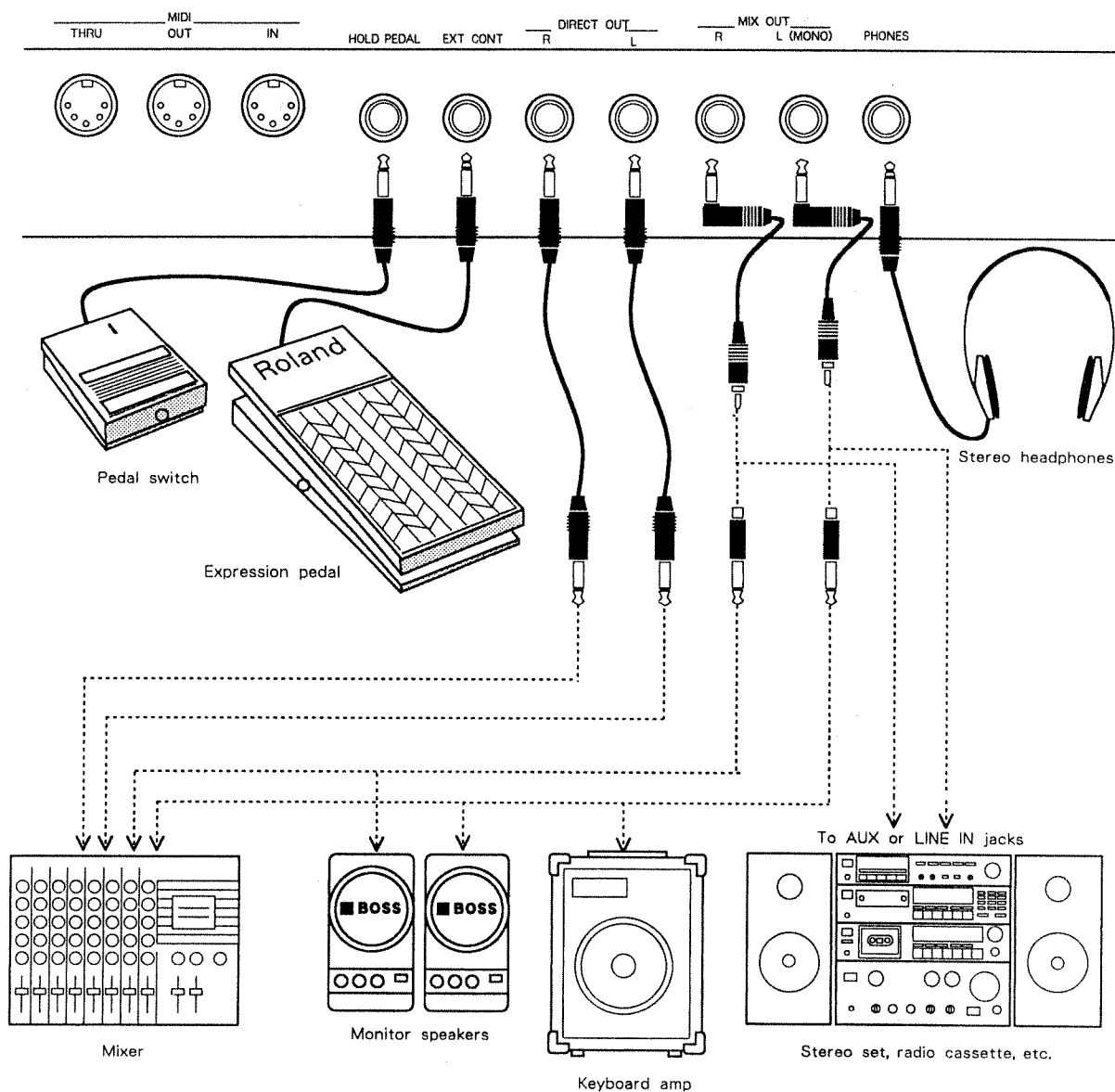

* With the factory settings, no sound will be output from the DIRECT OUT jacks.

* If the DIRECT OUT jacks are not used, sound will be output from the MIX OUT jacks.

* For MIDI applications, see "MIDI connections" (P. V - 2).

1. PREPARATIONS

How to turn the power on

● Turn the power on/off

In order to prevent damage to your equipment, please turn the power on/off in the following order.

○ How to turn the power on

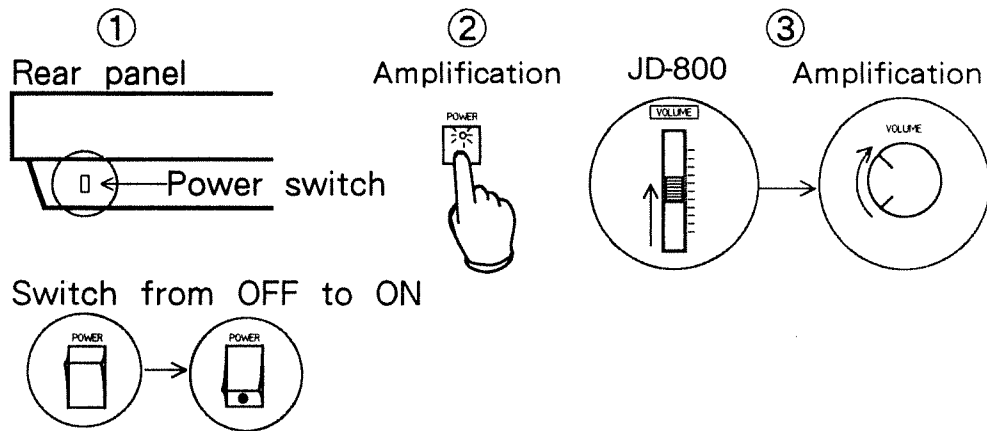

① Turn the JD-800 power on.

The following screen will appear.

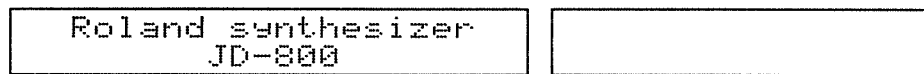

* Immediately after power up, a protection circuit will function for a few seconds. No sound will be heard during this time.

② When the following screen appears, turn on the power to your amplifier system.

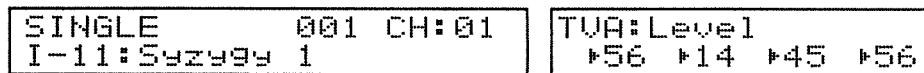

③ Raise the JD-800 volume to an appropriate level, and while playing the keyboard, adjust the volume of your amplifier system.

○ How to turn the power off

When turning the power off, use the reverse order.

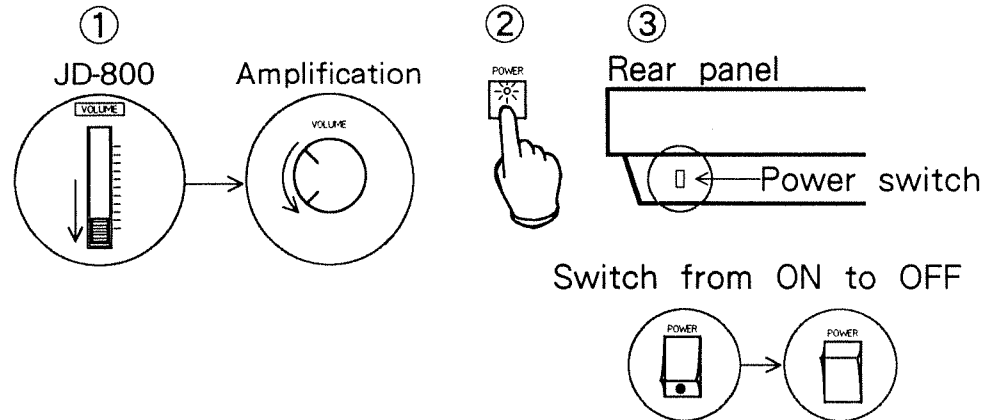

- ① Lower the volume of your amplifier system and the JD-800.
- ② First turn off your amplification system.
- ③ Then turn off the JD-800.

2. HEAR THE DEMO SONG

Here's how to hear the "ROM Play" demo song built into the JD-800. Each mode (Single/Multi) has one demo song.

● ROM Play in Single mode

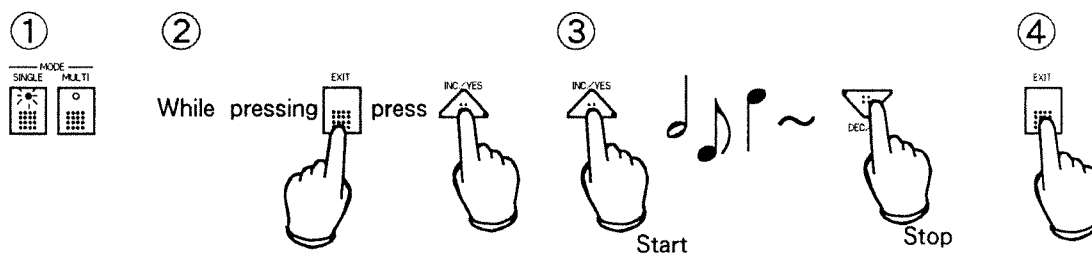

① Check if the current status is Single mode.

② While holding **EXIT**, press **INC/YES**. The following display will appear.

```
=====  
ROM PLAY  
Introduction  
=====
```

③ Press **INC/YES** and playback will begin. Press **DEC/NO** and playback will stop.

```
=====  
PLAYING  
**** JD-800 ****  
=====
```

④ Press **EXIT** once again to return to Single mode.

* During ROM Play in the Single mode, the informations of phrases are appeared in the display.

Example:

```
=====  
PLAYING  
..Digital Waves,  
=====
```

* It is not possible to play the keyboard during ROM Play.

* The ROM Play data is not transmitted from MIDI OUT.

● ROM Play in Multi mode

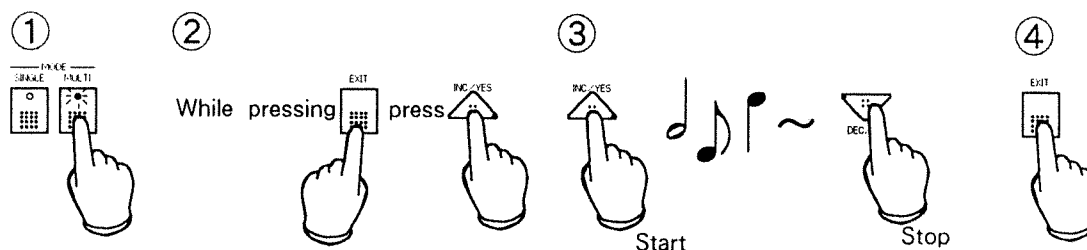

① Press **MULTI**.

② While holding **EXIT**, press **INC/YES**. The following display will appear.

```
===== ROM PLAY =====
           Eau De Vie
```

③ Press **INC/YES** and playback will begin. Press **DEC/NO** and playback will stop.

```
===== PLAYING =====
           Eau De Vie
```

④ Press **EXIT** once again to return to Multi mode.

Single mode	Multi mode
<p>"Introduction"</p> <p>Music by Adrian Scott & Tatsuya Nishiwaki Copyright © 1991, Adrian Scott</p>	<p>"Eau De Vie"</p> <p>Music by Adrian Scott Copyright © 1991, Adrian Scott</p>
<p>Biography of Composer</p>	
<p>Adrian Scott</p> <p>Adrian Scott formerly handled the vocals and keyboards for the popular group from Australia, "Air Supply". Since following the solo path, he in 1984 won the Silver Prize at the "World Song Festival Tokyo '84". Currently, he is involved as a producer of commercial music and music for films. In addition, as a session player, he has performed along with a number of Australia's top musicians, including John Farnham and Kylie Minogue. He lives in Melbourne, Australia.</p>	
<p>Tatsuya Nishiwaki</p> <p>Debuted in 1987 as a member of "PAZZ" for CBS/Sony records. After the group's dissolution in '88, he was involved in the production of numerous albums (composing, arranging and playing keyboards). His work, and his individualistic style of playing, have won him wide acclaim. His particular musical sensibility results in emotional, exciting keyboard playing, combined with arrangements which deftly support his style. "Introduction" offers a good measure of wild playing combined with distorted sounds (Plus Distortion!).</p>	
<p>Warning : All rights reserved. Unauthorized use of this material is a violation of applicable laws.</p>	

* It is not possible to play the keyboard during ROM Play.

* The ROM Play data is not transmitted from MIDI OUT.

3. SELECT SOUNDS AND PLAY

Each of the sounds in the JD-800 is called a "Patch". Each Patch is numbered and can be recalled simply by entering its number. When the JD-800 is shipped, the 64 internal Patch memories contain factory preset Patch data.

a. Single mode

● How to select a Patch

In Single mode, the entire JD-800 will function as a single instrument. This instrument can produce many different types of sound.

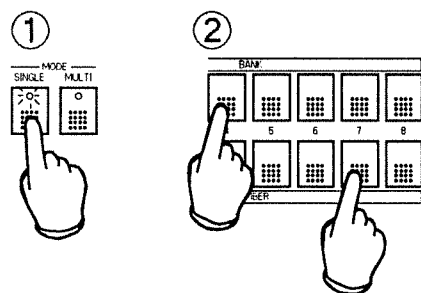

- ① Press **SINGLE**. The button indicator will light, and the following display will appear.

Program change number		MIDI receive channel	Tone parameter				
↓		↓	↓				
SINGLE	001	CH:01	TVA:Level	▶56	▶14	▶45	▶56
I-11:Swygy 1			TONE A	TONE B	TONE C	TONE D	
↑	↑						
Patch number	Patch name						

- ② Press **BANK** [1]—[8] and then press **NUMBER** [1]—[8], and a Patch will be selected.

For example, if you press **BANK** [4] and then **NUMBER** [7], Patch I-47 will be selected.

SINGLE	031	CH:01	TVA:Level	75	▶80	▶85	▶80
I-47:Evanson9 Vox							

*The Patch will not change until you press the number button.

*Before a newly purchased DATA card can be used, it must be Initialized (☞ P. IV - 12).

The Patches in the JD-800 are organized into eight banks (BANK) with eight numbers (NUMBER) in each bank, for a total of 64 (8 × 8) Patches.

If you use a DATA card to store Patches that you have created, you will be able to select from a total of 128 Patches.

Refer to the "Patch List" provided, and use the following procedure to select Patches in Single mode.

b. Multi mode

When using Multi mode, it will be necessary to understand the concept of the “Part”. If we use the analogy of a band, each musician playing drums, bass, guitar, etc. corresponds to a “Part”, and the instrument each musician plays corresponds to a “Patch”.

By using a sequencer to control each Part independently, the JD-800 can produce the sounds of an entire ensemble.

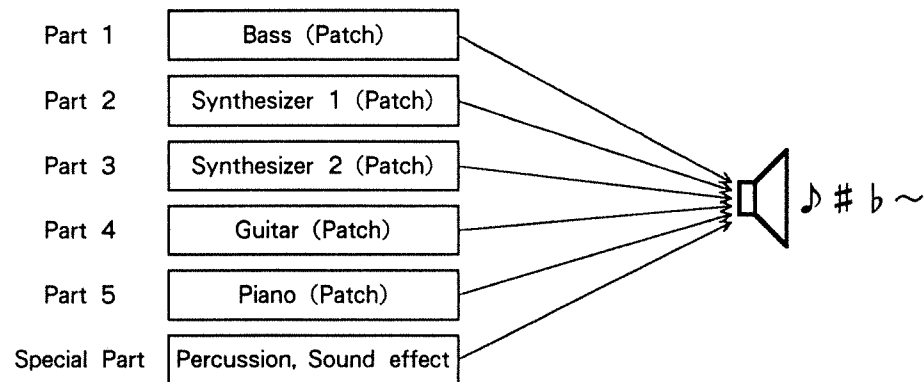

● How to select the Part

To make the musicians in a band play music, it is necessary to give instructions to each musician. In Multi mode on the JD-800, selecting a Part is analogous to getting the attention of one of the musicians before you give instructions!

Here's how to select a Part.

- **Synth Parts** Parts 1—5 are called “Synth Parts”. You can specify the Patch (instrument) that will be played by each Part (musician).

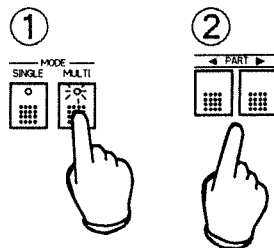

3. SELECT SOUNDS AND PLAY

How to select the part

- ① Press **MULTI** to enter Multi mode.
- ② Use the **◀PART▶** buttons to select each Part, and check the Patch that has been assigned to each Part.

MULTI Part5 010 CH:05 I-22:Classic Sweeper	TVA:Level1 ▶79 ▶79 ▶79 ▶79
---	-------------------------------

* When you change from Single mode to Multi mode, the Part which was selected just before will be selected, and will play the Patch which is assigned to it. When you change from Multi mode to Single mode, the Patch that was last selected in Single mode will be selected.

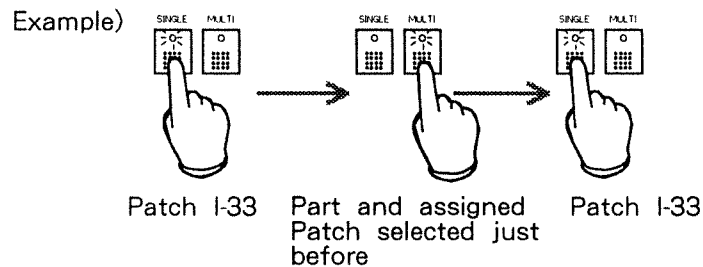

The Patch also changes when you change Parts ?!

As you have noticed, the Patch will change when you move to a different Part. When a different musician (Part) is selected, it is obvious that the instrument (Patch) will also change.

If you select a Patch for each Part in the order that you wish to play Patches, you can rapidly select Patches by pressing **◀PART▶**.

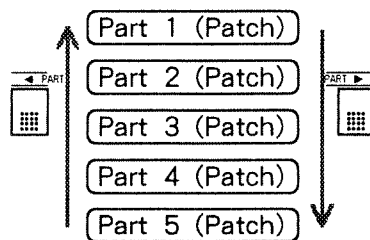

○ The Special Part

Next select the Special Part. In this part, a different sound is assigned to each key. You can think of the Special Part as a musician who has many different instruments. This is called “Special Setup”.

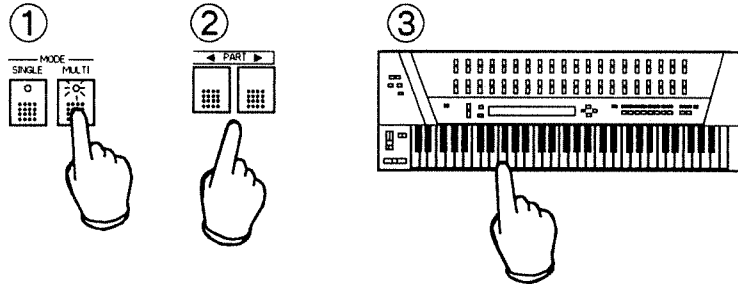

- ① Press **MULTI** to enter Multi mode.
- ② Press **PART** until the following display appears.

```
MULTI Part5 001 CH:10
INTERNAL Setup
```

- ③ Press each key to hear the various sounds.

Each note of the keyboard will play a different sound; percussive sounds, sound effects, synthesizer sounds, and many others.

Refer to the “Setup List” provided and listen to the various sounds that are provided.

3. SELECT SOUNDS AND PLAY

How to select a Patch for a part

● How to select a Patch for a Part

Here's how to select the Patch that will be played by each Part. The procedure is essentially the same as for Single mode, and the Patches that can be selected are also the same as in Single mode.

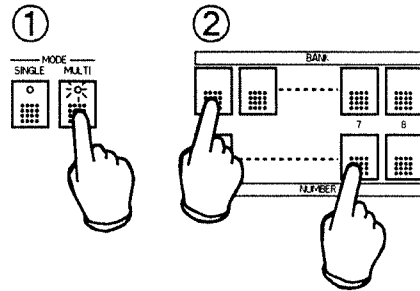

- ① Press **MULTI**. The button indicator will light, and the following display will appear.

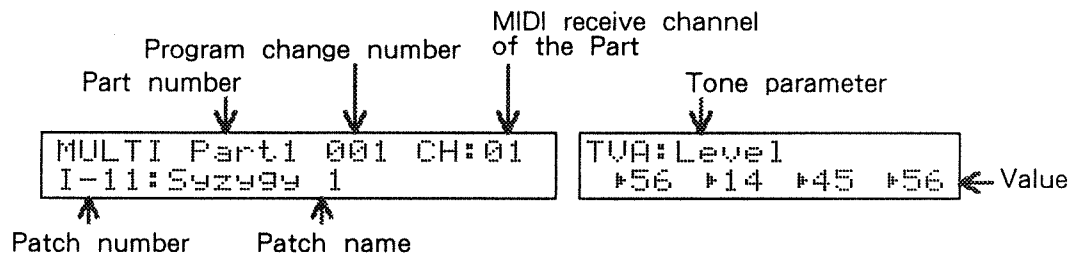

- ② To select a Patch, press **BANK** [1]—[8] and then press **NUMBER** [1]—[8].

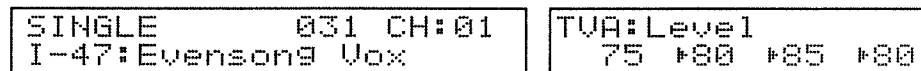

*The Patch will not change until you press the number button.

Defference of Effect between Single mode and Multi mode

When the mode changes, the sound also changes?

By now you have probably selected and played many different Patches. You may have noticed that the same Patch (for example, I-15) may sound different depending on whether it is selected in Single mode or in Multi mode. The reason for this is as follows.

《Effect system in Single mode》

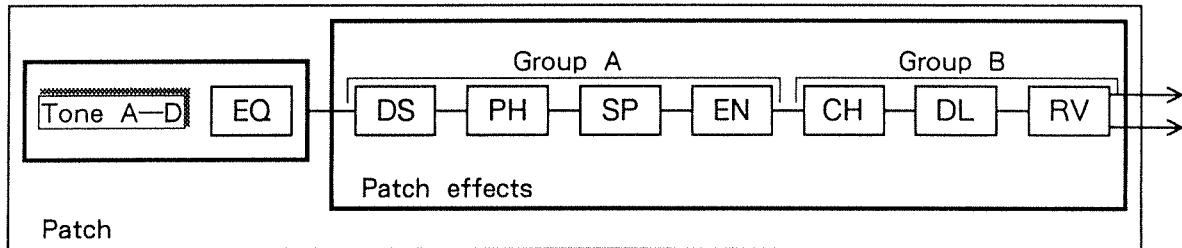

《Effect system in Multi mode》

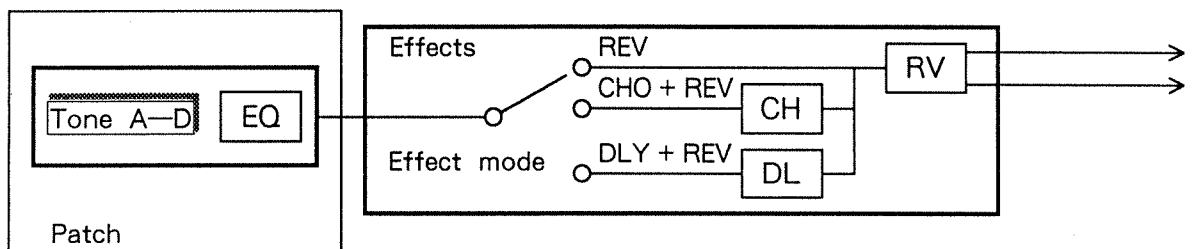

- | | |
|-----------------|-------------|
| DS : distortion | CH : chorus |
| PH : phaser | DL : delay |
| SP : spectrum | RV : reverb |
| EN : enhancer | |

The above diagrams show how the effect system is structured differently in Single mode and in Multi mode.

In Single mode each Patch has its own effects settings. However, in Multi mode, the effect settings of each Patch are ignored, and a set of effects settings common to all six Parts is used.

If a Patch in Single mode uses effects (such as distortion) to radically modify the sound, the same Patch will sound quite different when played in Multi mode.

Be aware that Patches will sound different in Single mode and in Multi mode.

【MEMO】

How to modify sounds

One of the primary attractions of synthesizers is that they allow you to create virtually any type of sound. However, it is not easy to create a sound from scratch. In this chapter we will begin by selecting a sound and modifying it in various ways. After you have become familiar with this process, you can try creating a sound from scratch.

When learning how to edit sounds, experience is the best teacher. If you continue experimenting (even if some of your experiments are unsuccessful), you will eventually be able to create the sounds you want.

The process of modifying a sound is called “editing”, and each aspect of the sound you modify is called a “parameter”. This chapter will explain the basic procedure for editing.

1. PATCH EDITING

“Patch editing” is how you will usually create sounds. By this, we mean the process of modifying the various Tone parameters and Patch parameters (common, EQ, effects).

a. Before you begin editing

You may be thinking that all the sliders and buttons seem very complicated, but take another look at the front panel. Notice that the sliders and buttons are grouped into several blocks. The fastest way to understand the JD-800 is to gain a general understanding of what each block does. Before you actually begin editing, we will make a short side trip to explain how the JD-800 is organized.

*** From this page forward, in some cases, the patch name and parameter values shown in the illustration are different from those in the actual display.**

● How a Patch is organized

The PATCH block is located in the upper left portion of the front panel. This section is the core of a Patch.

A “Patch” in the JD-800 consists of four Tones, and settings for Common and Effects. The buttons in this block have the following functions.

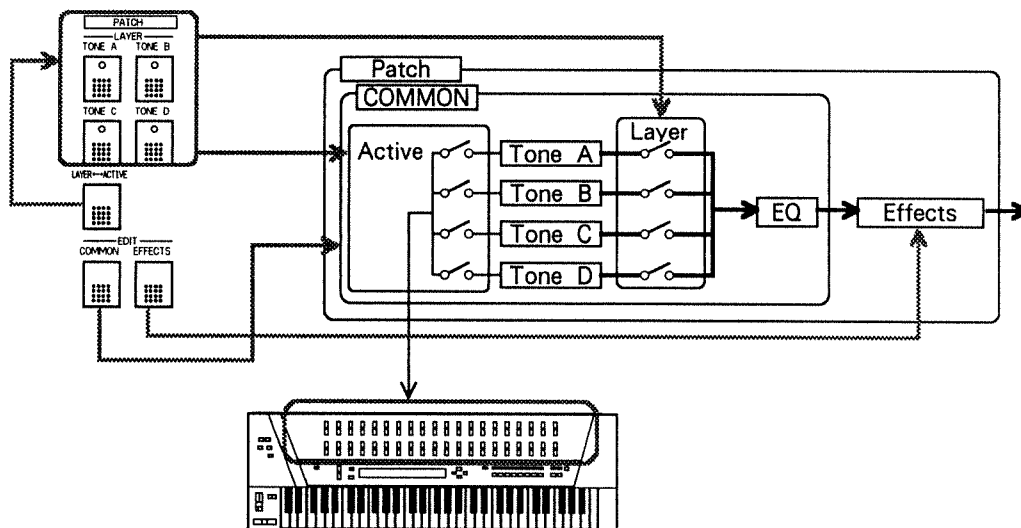

LAYER (TONE A — TONE D)

These buttons turn on/off (mute) each Tone. The button indicators will light to indicate Tones that are on.

LAYER ↔ ACTIVE

Press this button to select the Tone you wish to edit using the front panel sliders and buttons. The Tone whose indicator is blinking can be edited. Press TONE A — TONE D to select the Tone you wish to edit.

Press LAYER ↔ ACTIVE once again, and the indicators will now show the Layer status (lit/unlit). Press TONE A — TONE D to turn each Tone on/off.

COMMON

Press this button to edit Patch Common parameters. Equalizer and MIDI Transmit parameters are also included here.

EFFECTS

Press this button to edit Patch Effects parameters.

***In Multi mode however, since the Effects block settings of a Patch will be ignored, pressing this button will not allow you to edit Effects settings. To make Effects settings, press the EFFECTS button of the SYSTEM block.**

● How a Tone is organized

The sliders and buttons in the center of the front panel affect the active Tone, and are grouped into several blocks.

The front panel of the JD-800 provides sliders and switches for the parameters of only one Tone. Use the **LAYER ↔ ACTIVE** button to select the Tone you wish to edit or to sound.

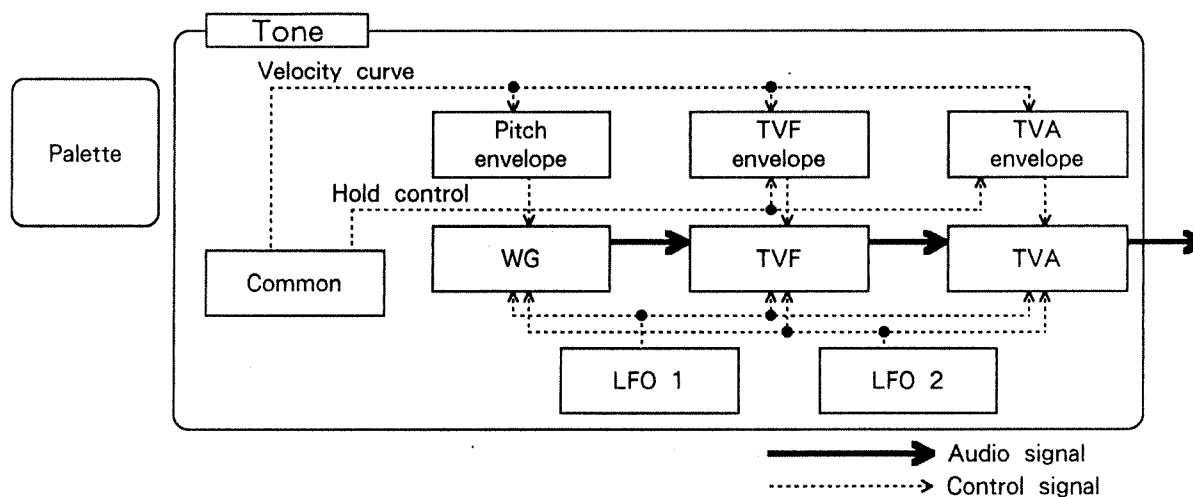

PALETTE block The parameter shown in the Tone display can be edited independently for all four Tones (☞ II P. I - 9).

COMMON block Select the velocity curve that will apply to the entire Tone, and turn the Hold pedal on/off (☞ II P. I - 15).

LFO block Make LFO settings to create vibrato, wah-wah, and tremolo effects (☞ II P. I - 19).

WG (Wave Generator) block

Select the waveform that will be the core of the sound, and specify the pitch (☞ II P. I - 27).

PITCH envelope block

Make envelope settings to specify how the pitch will change over time (☞ II P. I - 44).

TVF (Time Variant Filter) block

Select the filter type, and adjust the tone color (☞ II P. I - 50).

TVF envelope block

Make envelope settings to specify how the tone color will change over time (☞ II P. I - 60).

TVA (Time Variant Amplifier) block

Specify how the volume will be adjusted across the keyboard, etc (☞ II P. I - 66).

TVA envelope block

Make envelope settings to specify how the volume will change over time (☞ II P. I - 75).

b. Tone editing procedure

We have explained that a Tone consists of several blocks. Now we will modify some of the basic aspects (“parameters”) of the Tone.

For a more detailed explanation of each parameter, refer to the appropriate page of the Reference Manual.

Make sure that you are in Single mode, and select Patch I-46.

● Select a Tone

First we will determine which Tones are being used. The four buttons under LAYER indicate the status of the four Tones. Tones whose indicators are lit will sound, and Tones whose indicators are dark will not sound.

Press any Tone button A—D, and you can see which Tones make up the current Patch.

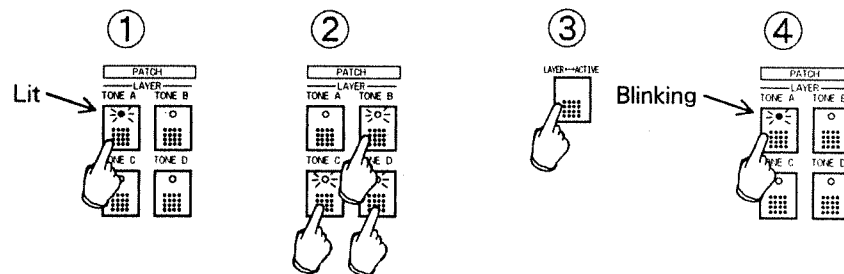

- ① When you press a Tone button whose indicator is lit, the indicator will go out and that Tone will no longer sound; i.e., it will be “muted”.
Mute Tones B—D, leaving only Tone A. Now you will only hear the sound of Tone A.
- ② Using the procedure of step ①, check the sound being produced by Tones B/C/D. After you have checked the sound of each Tone, mute Tones B/C/D so that only Tone A sounds. This will make the effects of your editing easier to hear.
- ③ Next press **LAYER ↔ ACTIVE**. The indicators for Tones A—D will blink. The blinking Tones can be edited from the front panel.
- ④ Press the buttons so that only Tone A is blinking, and Tones B/C/D are unlit. Now only Tone A can be heard and edited.

```
SINGLE          030 CH:01
I-46: Pain&Injury Keyz
```

```
TVA:Level1
▶64 64 70 80
```



This indicates the Tone that will be edited.

Now let's edit Tone A.

1. PATCH EDITING

Change the waveform

● Change the waveform

The WAVEFORM parameter determines the “waveform” which is the core of the sound. As shown in the wave list below, a wide variety of synth waveforms such as SAW, SQUARE, SIN, and noise are provided. Take a look at the wave list.

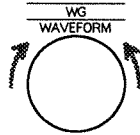

- ① Rotate the WAVEFORM dial located in the center of the WG block. The display will show the number and name of the selected waveform.

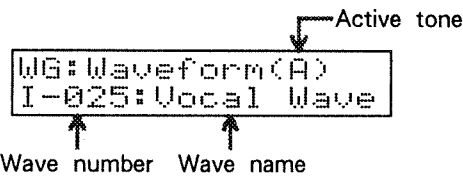

*The waveforms in internal memory are numbered 001—108.

*Unlike a conventional volume knob, the WAVEFORM dial can be rotated continually in either direction. As you rotate the dial to the right, higher numbers will be selected. As you rotate the dial to the left, lower numbers will be selected. The display will stop changing when the lowest or highest numbered waveform is reached.

Wave number	Wave name	Comments	Wave number	Wave name	Comments	Wave number	Wave name	Comments	Wave number	Wave name	Comments
001	Syn Saw 1	Analog waves	028	Digiwave	Digital waves	055	Tabla	Percussive sounds	0082	Cowbell	Attacks
002	Syn Saw 2		029	Can Wave 1		056	Pole Ip		083	Sm Metal	
003	FAT Saw		030	Can Wave 2		057	Pluck Harp		084	StrikePole	
004	FAT Square		031	EML 5th		058	Nylon Str		085	Pizz	
005	Syn Pulse1		032	Wave Scan		059	Hooky		086	Switch	
006	Syn Pulse2		033	Nasty		060	Muters		087	Tuba Slap	
007	Syn Pulse3		034	Wave Table		061	Klack Wave		088	Plink	
008	Syn Pulse4		035	Fine Wine		062	Crystal		089	Plunk	
009	Syn Pulse5		036	Funk Bass1		063	Digi Bell		090	EP Atk	
010	Pulse Mod		037	Funk Bass2		064	FingerBell		091	TVF_Trig	
011	Triangle	038	Strat Sust	065	Digi Chime	092	Flute Tone	Winds			
012	Syn Sine	039	Harp Harm	066	Bell Wave	093	Pan Pipe				
013	Soft Pad	040	Full Organ	067	Org Bell	094	BottleBlow				
014	Wire Str	041	Full Draw	068	Scrape Gut	095	Shaku Atk				
015	MIDI Clav	042	Doo	069	Strat Atk	096	FlugelWave				
016	Spark Vox1	043	ZZZ Vox	070	Hellow Bs	097	French				
017	Spark Vox2	044	Org Vox	071	Piano Atk	098	WhiteNoise	Noise			
018	Syn Sax	045	Male Vox	072	EP Hard	099	Pink Noise				
019	Clav Wave	046	Kalimba	073	Clear Keys	100	Pitch Wind				
020	Cello Wave	047	Xylo	074	EP Distone	101	Vox Noise1				
021	BrightDigi	048	Marim Wave	075	Flute Push	102	Vox Noise2				
022	Cutters	049	Log Drum	076	Shami	103	CrunchWind				
023	Syn Bass	050	AgogoBells	077	Wood Crak	104	ThroatWind				
024	Rad Hose	051	Bottle Hit	078	Kimba Atk	105	Metal Wind				
025	Vocal Wave	052	Gamelan 1	079	Block	106	Windago				
026	Wally Wave	053	Gamelan 2	080	Org Atk 1	107	Anklungs				
027	Brusky Ip	054	Gamelan 3	081	Org Atk 2	108	Wind Chime	Effects			

WAVEFORM cards

If a WAVEFORM card (SO-JD80 series) has been inserted into the WAVEFORM card slot, you can also select waveforms from that card.

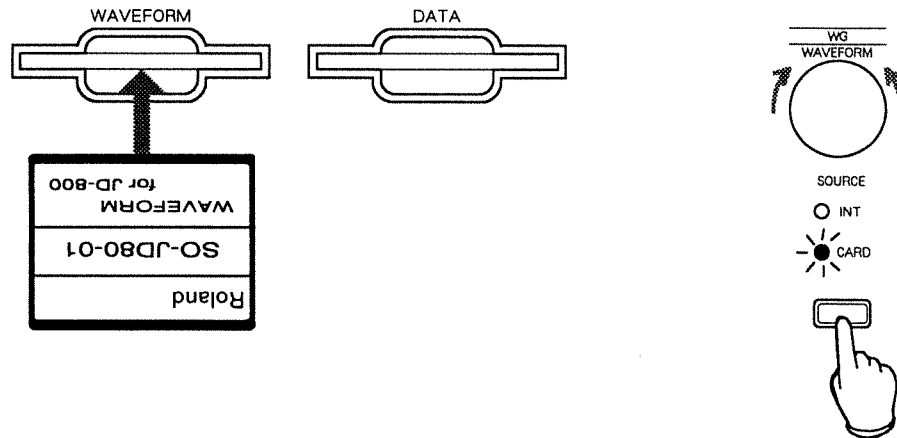

The printed side of the card is the front, and the other side with non-slip tread is the rear. With the front side forward, insert the card in the direction indicated by the arrow.

* The design of the actual card will differ from the illustration.

- ① Press **SOURCE** locate at the bottom of the WG block. When the CARD indicator is lit, you can rotate the dial to select waveforms from the WAVEFORM card.

```
WG: Wave source
*CRD INT INT INT
```

* If a WAVEFORM card has not been inserted, the following message will temporarily appear if you press the button (the CARD indicator will not light).

```
WAVEFORM card
is not ready
```

* For details, refer to the waveform list included with the WAVEFORM card.

● Modify the tone color

The selected waveform is sent through the “filter” to selectively cut portions of its harmonic structure. Here we will modify the tone color by changing the filter mode and adjusting the cutoff frequency and resonance.

◇ Mode

This specifies how the filter will affect the sound. If LPF is selected, lower values of the cutoff frequency will make the sound more mellow. If HPF is selected, higher values of the cutoff frequency will make the sound thinner. If BPF is selected, the cutoff frequency will determine the frequency range that is emphasized.

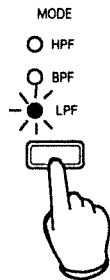

① Press **MODE**.

Each time you press the button, the next filter will be selected (in this order: HPF → BPF → LPF → HPF).

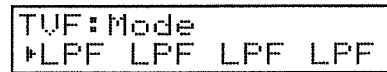

◇ Cutoff Frequency

This determines the point (frequency) at which the filter will affect the harmonic structure.



① Move **CUTOFF FREQ**.

The value will be 100 when the slider is fully raised, and 0 when fully lowered.

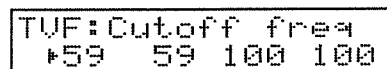

* For some waveforms you may hear no sound if this value is too low.

- ◇ **Resonance** This parameter adds emphasis to the overtones at the point (frequency) specified by the cutoff frequency, giving a unique character to the sound.



- ① Move **RESO**.

The value will be 100 when the slider is fully raised, and 0 when fully lowered.

```
TVF:Resonance
*00 00 00 00
```

*** Very high values (near 100) may drive the filter into oscillation, and cause the sound to distort.**

Adjust the TVA Envelope setting

● Modify the volume change

Now we will adjust the way in which the volume of the Tone changes over time. This change is created by the TVA Envelope. Most sounds have their own characteristic envelope. In this example, we will create three different types of envelopes; piano, organ, and strings.

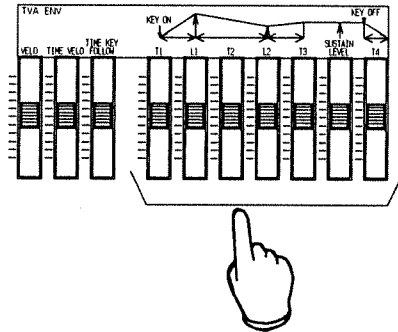

- ① Move the TVA block sliders **T1** through **T4**.

A-ENV:Time 1
 ▶41 44 00 00 Time 1

A-ENV:Level 1
 ▶100 100 100 100 Level 1

A-ENV:Time 2
 ▶100 100 59 95 Time 2

A-ENV:Level 2
 ▶00 00 00 00 Level 2

A-ENV:Time 3
 ▶72 00 00 92 Time 3

A-ENV:Sus level
 ▶00 00 00 00 Sustain level

A-ENV:Time 4
 ▶39 42 24 38 Time 4

Most instruments have one of the following types of envelope.

◇ Piano-type envelopes

$T1=0, L1=100, T2=60, L2=40, T3=70, \text{SusL}=0, T4=50$

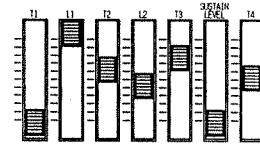
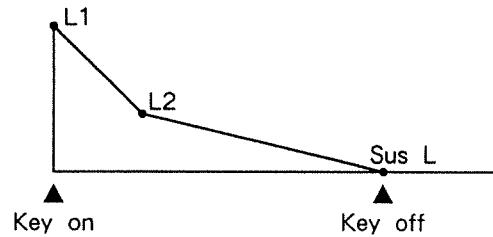

◇ Organ-type envelopes

$T1=0, L1=100, T2=0, L2=100, T3=0, \text{SusL}=100, T4=40$

L1, L2, SusL

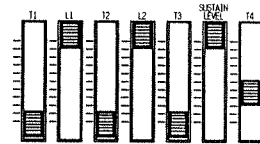
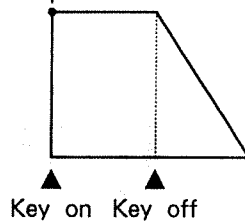

◇ String-type envelopes

$T1=50, L1=85, T2=30, L2=100, T3=0, \text{SusL}=100, T4=60$

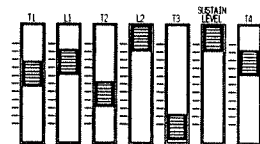
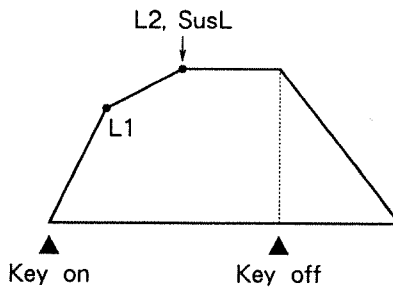

First make rough envelope settings and select an appropriate waveform to approximate the sound you want. Later you can make fine adjustments to complete the Tone.

● Add vibrato

“Vibrato” is an effect of cyclic variation in pitch. The shape or “waveform” of this variation is created by LFO1 and LFO2. In this example we will explain how to create vibrato that will be applied only when you move the MODULATION lever, and also how to create vibrato that will be automatically applied at all times.

◇ Modulation lever sensitivity

Vibrato can be controlled by the MODULATION lever. Here will specify the maximum depth of vibrato that will occur when the lever is pushed away from you (in the direction of the MODULATION arrow).

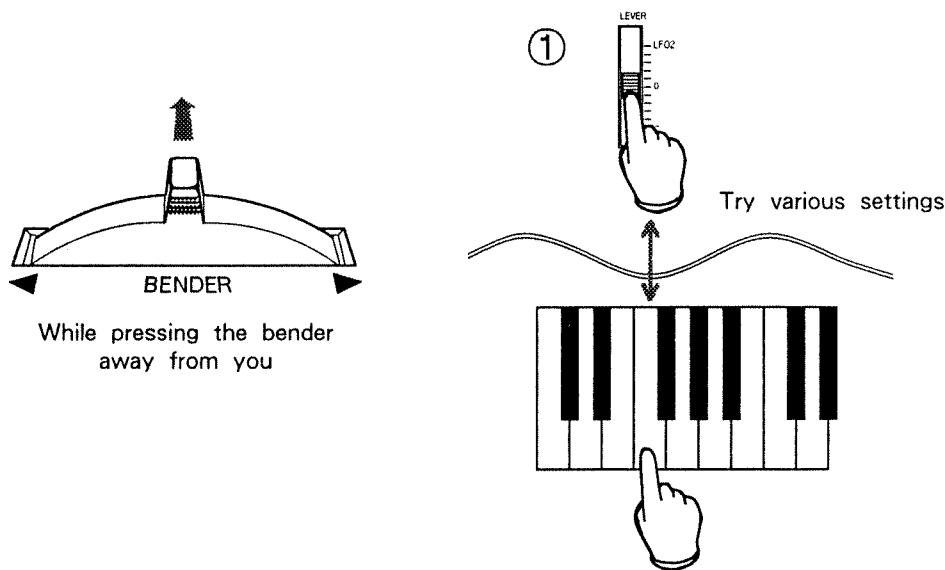

① Move the WG block **LEVER**.

If you set the slider above the center position (0), the MODULATION lever will create a vibrato effect using LFO1’s waveform. If you set the slider below the center position, the MODULATION lever will create a vibrato effect using LFO2’s waveform. The slider position will determine the amount of vibrato that is applied by the MODULATION lever. When the slider is in the center position, the MODULATION lever will not apply any vibrato.

```
WG: Lever sens
+050 00 020 00
```

▣ indicates LFO1, and ▤ indicates LFO2.

◇ LFO1/2 depth

Independent settings can be made for LFO1 and LFO2 so that vibrato is applied automatically.

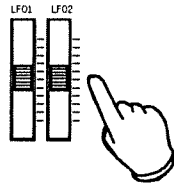

- ① Move the WG block **LFO1 / LFO2**.

If the slider is set in the center position, LFO settings will be ignored. Positive (+) settings will apply the LFO waveform in positive polarity. Negative (-) settings will invert the polarity of the LFO waveform.

```
WG:LFO 1 sens
▶+09 00 -12 00
```

*** By making the LFO settings shown below, you will be able to hear the vibrato effect clearly. For details of the parameters, refer to the Reference Manual.**

LFO1:

Rate = 75, Delay = 10, Fade = +20, Waveform = , Offset = 0, Key trigger = OFF

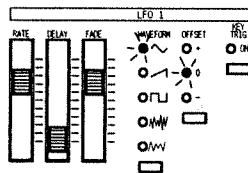

《How the LFO is applied》

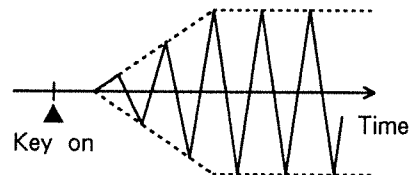

LFO2:

Rate = 40, Delay = 00, Fade = - 50, Waveform = , Offset = 0, Key trigger = ON

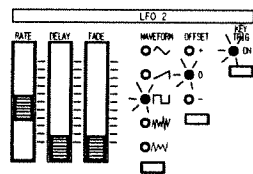

《How the LFO is applied》

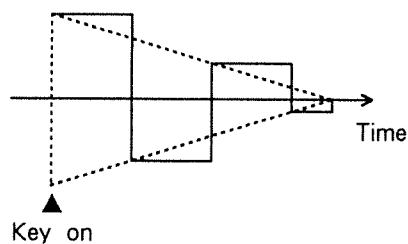

● Adjust the volume balance

You can adjust the volume balance of all four Tones at once.

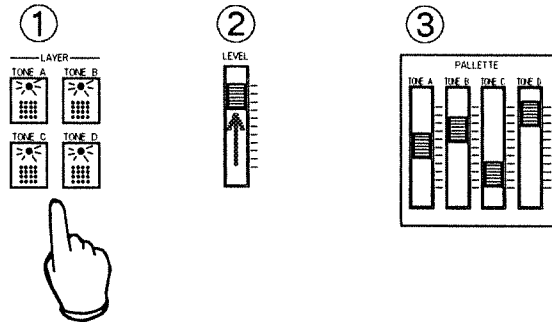

- ① If the indicator of Tone A is lit, turn on the muted Tones B/C/D. If the indicator is blinking, first press **LAYER \leftrightarrow ACTIVE**, and then turn on the muted Tones B/C/D.

SINGLE 030 CH:01	TVA ENV:Time4
I-46:Pain&Injury Keyz	▶39 42 24 38

- ② Move the TVA block **LEVEL** slightly.

The following display will appear.

TVA:Level
▶100 64 70 80

- ③ Move the PALETTE sliders **TONE A** — **TONE D**.

The display will show the levels of each Tone.

TVA:Level
▶55 70 18 90

You can think of this like a mixer that combines the sound from the four synthesizers (Tones) in the Patch. Specify the volume of each Tone, and use the Patch Level parameter to set the overall volume (☞ II P. I – 119).

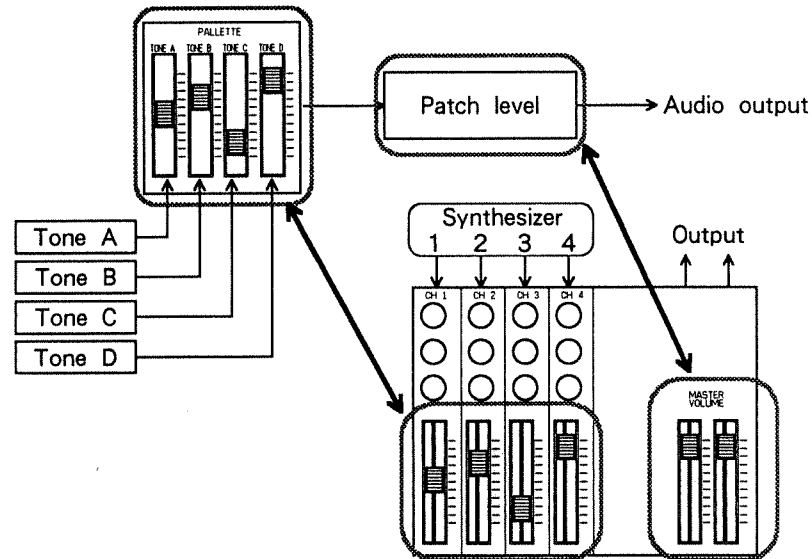

* The sliders of the PALETTE allow you to adjust the selected parameter shown in the display independently for each of the four Tones.

When you select a Patch, the TVA Level parameter will be selected, but for example if you then move the Cutoff Frequency slider, the Cutoff Frequency parameter will be selected.

In this way, you can edit the parameters of each of the four Tones. There are many other parameters, so go ahead and experiment to find new possibilities.

* If you want to save a Tone you create, use the Write operation (☞ P. III – 24) to store it into a Patch memory.

c. Patch editing

If you have been trying out the procedures we have explained so far, you should have a general idea of how to edit a Tone. Next we will edit some Patch parameters.

● Name the Patch

Here we will assign a new name to the Patch we are editing. A Patch can be given a name of up to 16 characters.

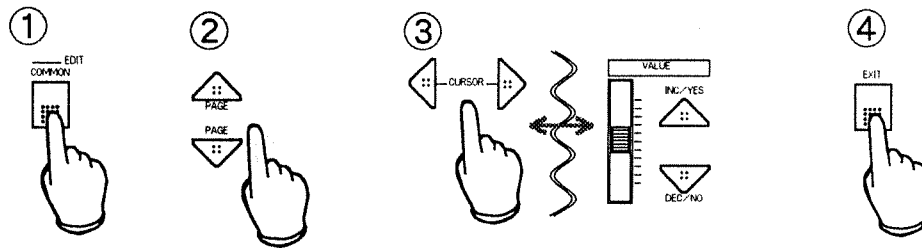

① In the PATCH section, press the EDIT block **COMMON** button.

② Press the PAGE **▲** **▼** buttons several times to select the following display.

```
PATCH COMMON
Name Pain&Injury Keyz
```

↑
Blinking

③ Use CURSOR **◀** **▶** to select the character you wish to change (the character will blink), and use **VALUE** or **INC/YES** and **DEC/NO** to select a new character.

In this example we will assign the name "JD-800".

```
PATCH COMMON
Name JD-800
```

↑
Blinking

④ Press **EXIT** to return to the previous play mode.

● Make equalizer settings

The equalizer allows you to modify the tone color by boosting or cutting specified frequency bands.

As we mentioned in the explanation of how a Patch is organized (P. III – 3), the four Tones are mixed and then sent through a 3-band equalizer.

In this example we will modify the settings of the middle band of the equalizer and hear how the sound is affected by each parameter; frequency, level, and Q (the width of the frequency band).

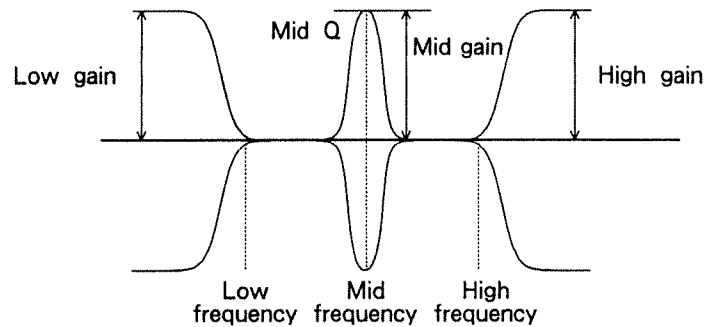

- ① In the PATCH section, press the EDIT block **COMMON** button.
- ② Press PAGE **▲** **▼** several times to select the following display, and then press **INC/YES**.

```
PATCH COMMON/EQ
Setup ?      [Y/N]
```

- ③ Press PAGE **▲** **▼** to select the following display, and then use **VALUE** or **INC/YES** and **DEC/NO** to set the value.

```
PATCH COMMON/EQ
Mid freq      800Hz
Mid Q         0.5
Mid gain      +00dB
```

Blinking

- ④ Select the each parameter and set its value. Notice how the sound changes.
- ⑤ Press **EXIT** to return to the previous play mode.

Equalizers are usually used to make minor adjustments to the sound, but on the JD-800 you may consider the equalizer settings as part of the sound itself. There are many possibilities when using the equalizer creatively.

1. PATCH EDITING

Make effect settings (Single mode)

● Make effect settings

The JD-800 has an on-board digital effects unit. In this section we will explain how the various effects are connected and how to turn them on/off. (For details of each effect parameter, consult the Reference Manual.)

***Be aware that the structure of the effects unit is different in Single mode and Multi mode. (“Effects in Multi mode” ⇨ P. III – 21)**

◇ Effects in Single mode

In Single mode, the effect unit provides seven effects in series. These effects are placed in order and turned on/off in different display pages. The effects are divided into two effect groups, A and B, and you will make settings separately for each group.

For details on the settings of each effect, refer to the Reference Manual (⇨ II P. I – 88).

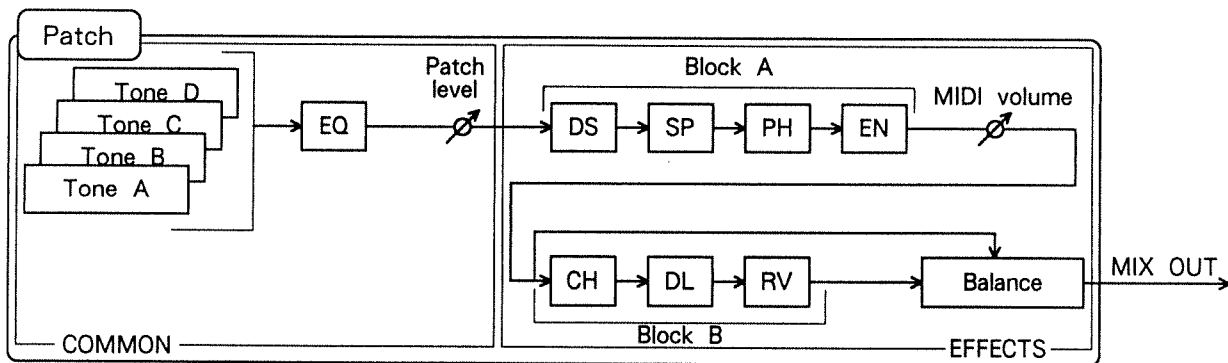

① In the PATCH section, press EDIT block **EFFECTS**.

In this display, you can specify how the effects of group A will be connected. The blinking “#” mark indicates the position at which an effect will be inserted.

```
PATCH EFF Sequence A
#-DS---PH---SP---EN-
```

② Use CURSOR **◀▶** to move the “#” mark to the location you want to change.

```
PATCH EFF Sequence A
-DS---PH-#-SP---EN-
```

Make effect settings (Single mode)

- ③ Use **VALUE** or the **INC/YES** and **DEC/NO** keys to select an effect to occupy that location in the chain of effects.

The selected effect will blink.

```
PATCH EFF Sequence A
-DS---PH-DS-SP---EN-
          ↑
        Blinking
```

- ④ After specifying the effect to occupy that location, press **CURSOR** **◀▶**.
The effect will be inserted at that position, and the order will change.

The " * " mark will reappear, and you can repeat steps ② and ③ to arrange the effects in the desired order.

```
PATCH EFF Sequence A
-[ ]---[ ]-*SP---EN-
```

- ⑤ Next, press **PAGE** **▲**.

In this page you can turn each effect on/off. A display of " [] " indicates that the effect assigned to that location has been turned off. Effects that are turned on are indicated by their abbreviation.

```
PATCH EFF Switch A
 * [ ]---[ ]---SP---EN-
```

- ⑥ Use **CURSOR** **◀▶** to move the " * " mark to the effect you wish to turn on/off.

```
PATCH EFF Switch A
-[ ]---[ ]-- * SP---EN-
```

- ⑦ Use **VALUE** or the **INC/YES** and **DEC/NO** keys to turn the selected effect on/off.

```
PATCH EFF Switch A
-[ ]---[ ]-- * [ ]---EN-
```

- ⑧ Repeat steps ⑥ and ⑦ as necessary.

1. PATCH EDITING

Make effect settings (Single mode)

- ⑨ Press PAGE , and you can specify the effect order for group B. Use steps ① to ⑧ to specify the order in which these effects will be linked.

```
PATCH EFF Sequence B
#-CH---DL---RV-
```

- ⑩ Press  to return to the previous play mode.

The following effects can be selected in each effect group.

Effect group A: distortion (DS), phaser (PH), spectrum (SP), enhancer (EN)

Effect group B: chorus (CH), delay (DL), reverb (RV)

*** It is not possible to reverse the order of groups A and B.**

*** When the Effect Master Switch ( II P. III - 9) in Tune/Function is turned OFF, Chorus/Delay/Reverb of Group B do not function.**

Make effect settings (Multi mode)

◇ Effects in Multi mode (Output Assign/Effect Mode/Effect Level)

In Multi mode, you can specify the effect assignment independently for each Part (and independently for each key of the Special Part).

The diagram below shows how you can set Output Assign to "MIX", and then select one of three Effect Modes; reverb, chorus+reverb, or delay+reverb.

If Output Assign is set to "direct", you can set the effect send level for each effect to 0, and thus indirectly turn effects on/off.

To make either setting, press **PART EDIT**, and modify the value in Part Edit (Special Setup Edit in the case of a Special Part).

For details of the various effect parameters, see the Reference Manual.

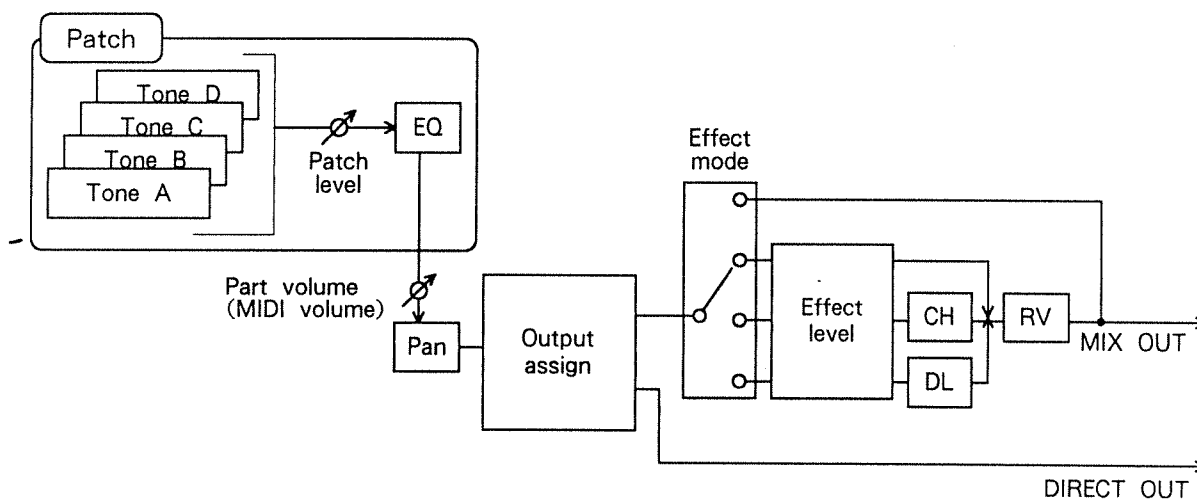

- ① Press **MULTI**, and then select the same Patch as you did in Single mode.
- ② Press **PART EDIT**. Then press PAGE **▲** **▼** until the following page appears.

```

PART EDIT Part1
Output Assign  MIX
                ↑
                Blinking
  
```

- ③ Use **VALUE** or **INC/YES** and **DEC/NO** to select "MIX".

1. PATCH EDITING

Make effect settings (Multi mode)

- ④ Press PAGE .

```
PART EDIT Part1
Effect mode    DLY+REV
```

↑
Blinking

- ⑤ Use **VALUE** or **INC/YES** and **DEC/NO** to select the effect.

- ⑥ Press PAGE  to select the following page, and use **VALUE** or **INC/YES** and **DEC/NO** to set the level of the sound which will be sent to the effect unit. At a value of 0 there will be no effect. A value of 100 will result in the maximum effect.

```
PART EDIT Part1
Effect level    100
```

↑
Blinking

- ⑦ Press **EXIT** to return to the previous play mode.

In step ⑤, the following selections are available.

- DRY : Effects will not be applied, and only the original sound will be output.
- REV : the sound with reverb will be sent from the MIX OUT jacks
- CHO+REV : the sound with chorus and reverb will be sent from the MIX OUT jacks
- DLY+REV : the sound with delay and reverb will be sent from the MIX OUT jacks

*** When the Effect Master Switch ( II P. III - 9) in Tune/Function is turned OFF, Chorus/Delay/Reverb of Group B do not function.**

d. When you finish editing

Now you know how to edit Tones and Patches, but there are several points you should remember when you finish editing.

● To recover the original sound

If you decide that you don't like the results of your editing, here's how to recover the original data of the Patch (the un-edited data).

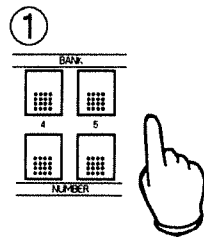

- ① While editing a Tone, press **EXIT** to return to play mode, and re-select the same Patch to recover the original settings.

● To store your edited sound

If you decide to keep your edited sound, you must use the Write operation. Changes you make affect only the “temporary” area. If you select another Patch, the settings of the temporary area will be replaced by the newly selected Patch, and you will lose your edits.

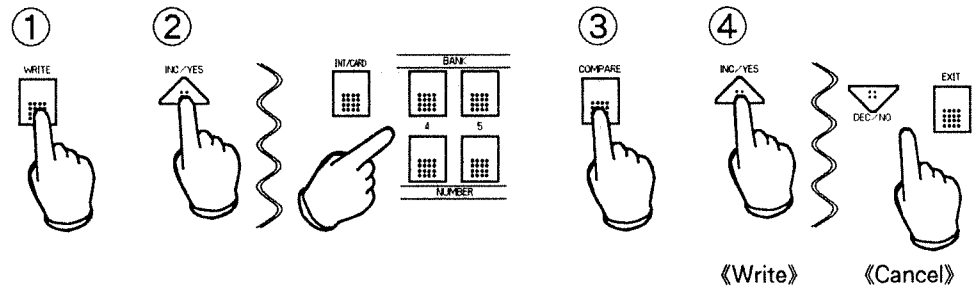

- ① While Patch editing or Tone editing, press **WRITE**.

```
WRITE from TMP
to I-46 ?      [Y/N]
```

This display is asking “should I write the edited settings from the temporary area into the currently selected patch (I-46)?”.

- ② If you want to write the edited settings into the same Patch memory, press **INC./YES**. If you want to write the edited settings into a different Patch memory, use **BANK** **1**—**8**, and **NUMBER** **1**—**8** to specify the destination.

```
WRITE from TMP
to I-33 ?      [Y/N]
```

- ③ By pressing **COMPARE** in step ②, you can check the sound of the Patch in the destination (patch compare).

```
COMPARE
TMP with I-33
```

When you have checked, press **COMPARE** once again. You will return to the write operation.

- ④ If you execute the Write operation, the display will read “Completed”. If you press **DEC./NO** or **EXIT**, the display will read “Canceled”, and you will return to the previous display page.

```
WRITE from TMP
to I-33      Completed
```

```
WRITE from TMP
to I-33      Canceled
```

2. SPECIAL SETUP EDIT

In the Special Part, a different Tone can be assigned to each key. The settings for all keys of the Special Part are referred to as a “Special Setup”.

Making settings for each Tone and for the Equalizer/Common is referred to as “Special Setup editing”.

a. Before you edit

Before you begin editing, we will explain how a Special Setup is organized.

● How a Special Setup is organized

Each of the 61 keys (C2—C7) in a Special Setup has its own Tone. This is the Key Setup block. The Common Setup block contains parameters that apply to all keys, such as equalizer settings.

The Tone assigned to each key is exactly the same as a Tone used in a Patch.

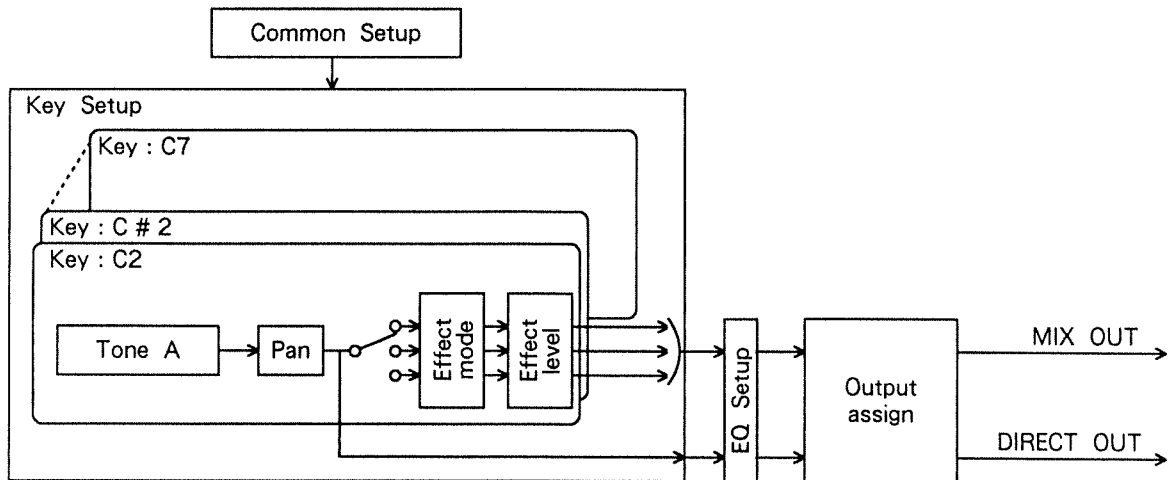

b. Editing procedure

When you are in Multi mode and have selected the Special Part, it is not possible to edit the Tone of the key being played. As explained earlier, a Special Setup is divided into three blocks, and you will edit the settings of each of these blocks. Thus, the procedure is different than for Patch editing.

● Modify the settings for individual keys

Now we will edit the settings for individual keys. The Tone editing procedure is the same as when editing a Patch, and will be omitted here.

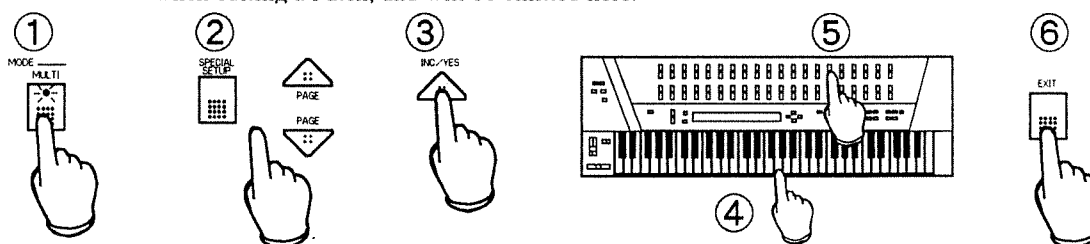

- ① Press **MULTI** to enter Multi mode.
- ② Press **SPECIAL SETUP**, and then use the PAGE **▲** **▼** keys to select the following display.

```
SPECIAL KEY
Setup ?      [Y/N]
```

- ③ Press **INC/YES**.

Tone name	Tone parameter
↓	↓
S.KEY[C4:BassDrum 1] Name BassDrum 1	TVA:Level ▶100 -- -- --
↑	
Blinking	

- ④ Press the key you wish to edit, and the panel controls will edit the Tone of that key.

S.KEY[F#2:ClosdHiHat] Name ClosdHiHat	TVA:Level ▶100 -- -- --
---	-------------------------------------

- ⑤ Use the panel sliders and switches to edit the Tone.
- ⑥ Press **EXIT** and you will return to the display of step ②. If you press **EXIT** once again, you will return to Multi play mode.

* The tone names and parameter values are different from those in the actual display.
 * Even if you press a different key while editing, the edited key settings will be preserved temporarily. However, if you turn the power off, they will be lost. If you want to keep your edited settings, execute the Write operation (☞ P. III – 30).

● Modify the Equalizer settings

The equalizer applies to all 61 keys.

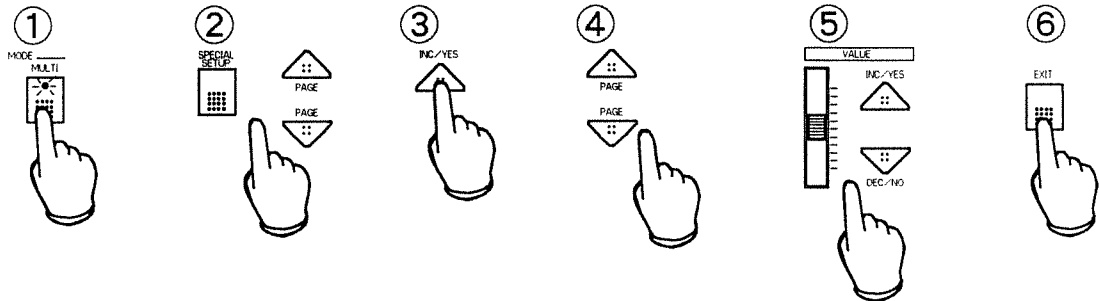

- ① Press **MULTI** to enter Multi mode.
- ② Press **SPECIAL SETUP**, and then use the PAGE **▲** **▼** keys to select the following display.

```
SPECIAL EQ
Setup ?      [Y/N]
```

- ③ Press **INC/YES**.
- ④ Press PAGE **▲** **▼** to select the parameter you wish to modify.

```
SPECIAL EQ
Low freq    200Hz
```

↑
Blinking

- ⑤ Use **VALUE** or the **INC/YES** and **DEC/NO** keys to set the value.

```
SPECIAL EQ
Low freq    400Hz
```

↑
Blinking

- ⑥ Press **EXIT**, and you will return to the display of step ②. If you press **EXIT** once again, you will return to Multi play mode.

* If you wish to keep the changes you make here, use the Write operation (→ P. III – 30).

● Modify the Common settings

Common settings include parameters that apply to all 61 keys, such as Bender Range and Aftertouch Bend Sensitivity.

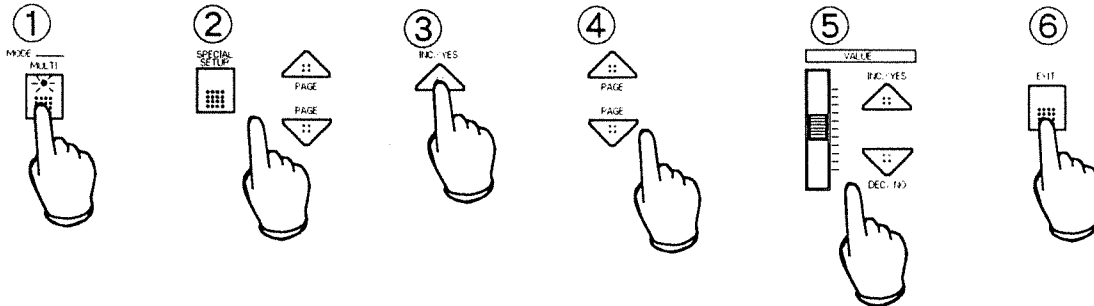

- ① Press **MULTI** to enter Multi mode.
- ② Press **SPECIAL SETUP**, and then use PAGE **▲** **▼** to select the following display.

```
SPECIAL COMMON
Setup ?      [Y/N]
```

- ③ Press **INC/YES**.
- ④ Press PAGE **▲** **▼** to select the parameter you wish to edit.

```
SPECIAL COMMON
Bender range D:12 U:02
```

↑
Blinking

D : indicates the pitch change that will occur when the bender lever is moved fully left.
U : indicates the pitch change that will occur when the bender lever is moved fully right.

- ⑤ Use **VALUE** or the **INC/YES** and **DEC/NO** keys to specify the value.

```
SPECIAL COMMON
Bender range D:36 U:02
```

↑
Blinking

- ⑥ Press **EXIT** and you will return to the display of step ②. If you press **EXIT** once again, you will return to Multi play mode.

* The Common settings you make here will be retained even if you do not execute the Write operation (☞ P. III -30).

c. When you finish editing

There are several points you should remember when you finish editing.

● To recover the original sound

If you decide that you don't like the results of your editing, here's how to recover the original data of a key.

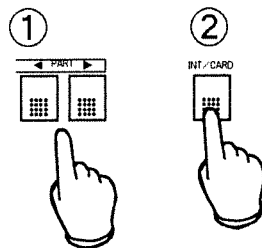

① Select the Special Part.

② Press **INT/CARD**.

The internal data will be copied into the temporary area, and the original settings will reappear.

* When an already initialized card is inserted, performing the second ② function will transfer all card data to the temporary area. To return to internal data, press **INT/CARD** again.

● To store your edited sound

If you decide to keep your edited settings, you must use the Write operation. Changes you make affect only the “temporary” area. If you turn the power off, your edited settings in the temporary area will be lost.

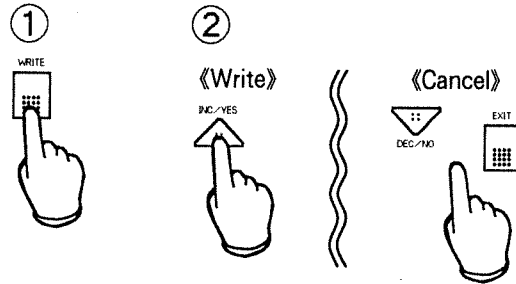

- ① While Setup editing, press **WRITE**.

```
WRITE SPECIAL Setup
to INT ?           [Y/N]
```

This display is asking, “do you want to write the modified Setup into the internal memory area?”.

- ② If you want to write the edited settings into the same key, press **INC/YES**. If you execute the Write operation, the display will read “Completed”. If you press **DEC/NO** or **EXIT**, the display will read “Canceled”, and you will return to the previous display page.

```
WRITE SPECIAL Setup
to INT           Completed
```

```
WRITE SPECIAL Setup
to INT           Canceled
```

3. LEARNING TO CREATE SOUNDS

We have been talking about “creating sounds”, but what exactly does this mean?

With a little basic knowledge, it is possible for anyone to create sounds. Let’s recall what we have done so far. Selecting a waveform or modifying the tone color are all part of the process of “creating a sound”. You might even say that randomly moving the sliders and pressing the buttons is also “creating a sound”.

But to create a musically useful sound, certain knowledge is required. This section will explain the basics of sound-creation.

We will also mention the JD-800 parameters that relate to each element of sound, so feel free to move the sliders to hear the results for yourself.

a. What is sound?

This is not as easy a question as it may seem. In our everyday lives, we are surrounded by sounds. These sounds are vibrations in the air that reach our ears. These vibrations are then interpreted by our brain as “sound”. Sound also changes in many ways as it travels through the air and reaches our ears. These changes affect the way we perceive sound.

● The basics of sound

By using an electronic measuring device such as an oscilloscope, we can view “sound” as a “shape” or “waveform”. Here we will explain the basic elements of sound.

○ Sound has three basic elements

The three basic elements of sound are pitch, tone color, and volume.

“Pitch” is determined by the speed at which the “wave” repeats. A waveform that repeats once a second is said to have a frequency of 1 Hz (hertz). Higher frequencies correspond to higher pitches, and lower frequencies correspond to lower pitches. For example, A4 = 440.0 Hz. If we move up one octave, the frequency is doubled (A5 = 880 Hz). If we move down one octave, the frequency is halved (A3 = 220.0 Hz).

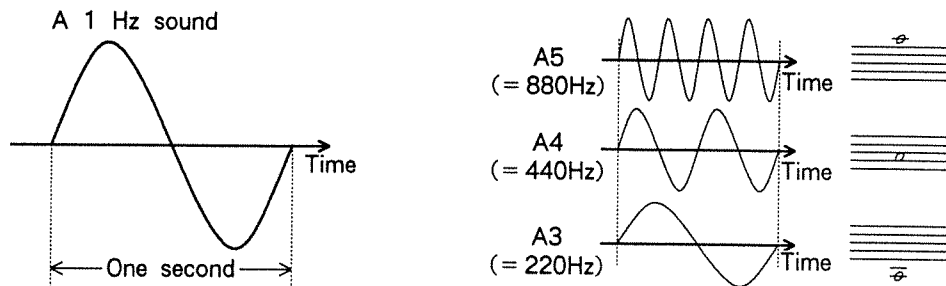

WG parameters such as Pitch Coarse, Pitch Fine, Pitch Key Follow, and Pitch Random determine the pitch of the sound (⇐ II P. I – 28、 I – 29、 I – 30).

3. LEARNING TO CREATE SOUNDS

Three basic elements of sound

◇ Tone color

Tone color is determined by the shape of the wave. For example, the diagram below compares the waveform of a piano to a simple sine wave. Notice that the piano waveform is much more complex. Our ears perceive this complexity as tone color. Tone color is closely related to the “partials” that we will be talking about later.

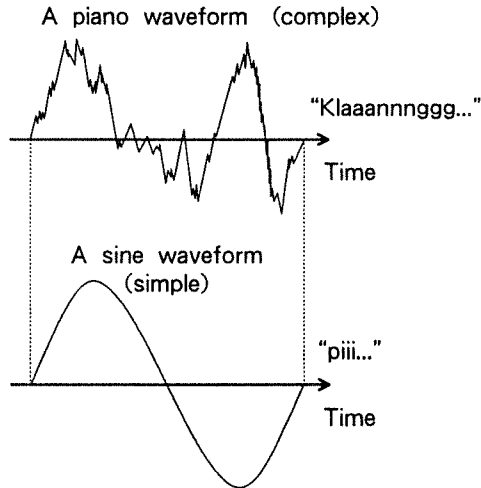

Piano waveform : a rich sound
Sine waveform : a simple sound

In the JD-800, the WG block determines the waveform (☞ II P. I – 36).

◇ Volume

Volume is determined by the amplitude (width) of vibration. As the amplitude increases, the volume will increase. As the amplitude decreases, the volume will decrease.

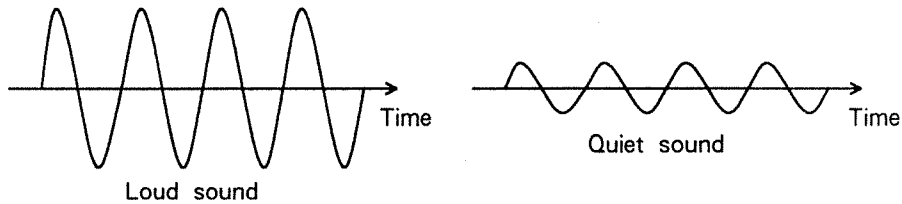

In the JD-800, the volume is adjusted by the TVA parameters Level and Bias Level (☞ II P. I – 67— I – 71).

○ Partials

We have explained that tone color is determined by the shape of the waveform, but what determines the shape of the waveform?

Each of the sine waves that is added to the fundamental to make up a complex wave is known as a “partial”. There are two types of partial; “harmonic” partials which are multiples of the fundamental frequency (i.e., fundamental x 1, x 2, ...), and “inharmonic” partials which are not multiples of the fundamental frequency. The sounds we hear are made up of various combinations of partials.

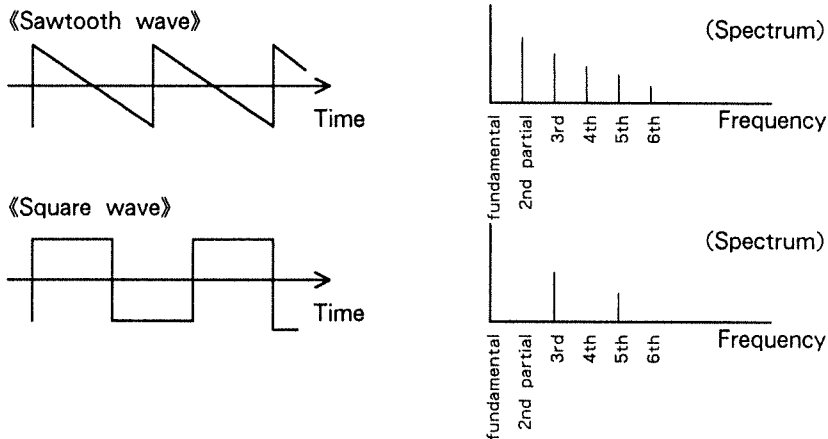

Selectively cutting the partial spectrum of a complex waveform to create the desired sound color is a well-known technique of synthesis called “subtractive synthesis”. Subtractive synthesizers contain waveforms that have a large number of partials, and provide a “filter” to subtract specified portions of the spectrum to modify the sound.

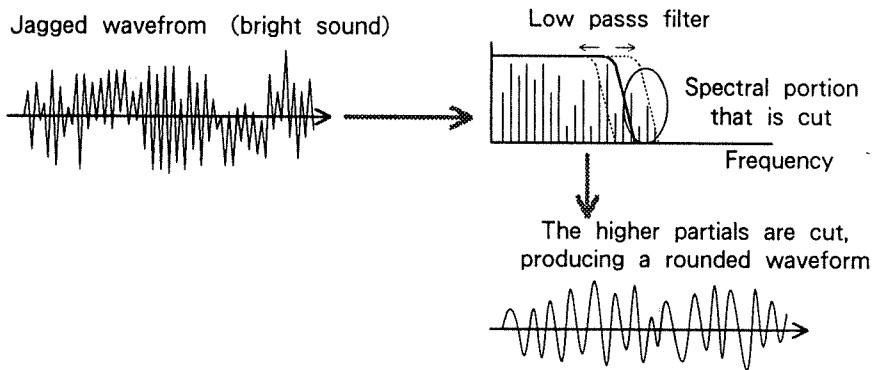

In the JD-800, the TVF parameters [Filter Mode, Cutoff Frequency, Resonance, and Cutoff Key Follow] affect the tone color (☞ II P. I - 51— I - 56).

Envelopes

○ Change over time (envelopes)

Most acoustic instruments have a characteristic pattern in which their waveform changes over time. Change can occur in all three elements of sound; pitch, tone color, and volume. This change in time is called an “envelope”.

◇ Pitch envelope

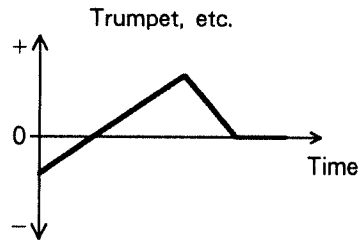

Brass instruments such as the trumpet often have slight changes in pitch at the beginning of a note. On synthesizers, the section that creates change in pitch over time is called the “pitch envelope generator”. On the JP-800, this is controlled by the parameters of the PITCH ENV block (☞ II P. I – 44).

◇ TVF envelope

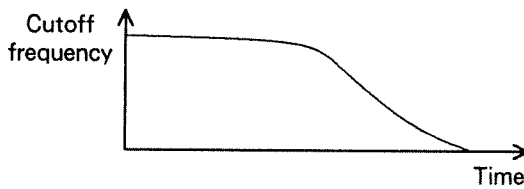

Such as the piano, the beginning of each note is bright and contains many harmonic partials. As time passes, the sound gradually becomes darker (less bright). On the JD-800, change in tone color over time is produced by the TVF envelope, as determined by the parameters of the TVF ENV block (☞ II P. I – 60).

◇ TVA envelope

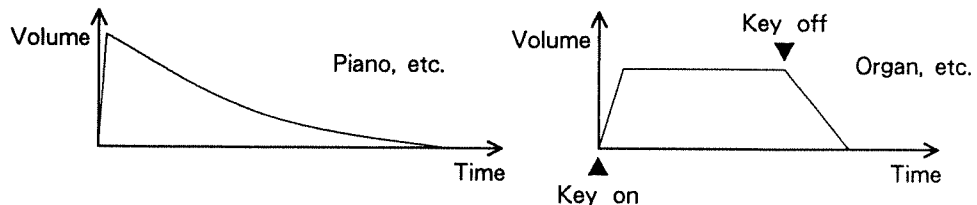

The notes of a piano begin immediately when the key is pressed, and gradually become softer. The notes of an organ remain at the same volume as long as the key is pressed. On the JD-800, change in volume over time is produced by the TVA envelope, as determined by the parameters of the TVA ENV block (☞ II P. I – 75).

○ Combinations of sound

All acoustic sounds can be thought of as having the “three elements of sound”, and “change in sound color over time”. In addition, these sounds can be thought of as being made up of several different types of sound.

For example if we were to analyze the sound of a piano, we would find that each note consists of a short percussive sound caused by the hammer strike, and the sound produced by the vibrating string. To give another example, the sound of a flute consists of the irregular breath noise at the beginning of each note, and the vibration of the air column.

These are known as “sound components”. By combining these components in various ways, we can create more realistic sounds.

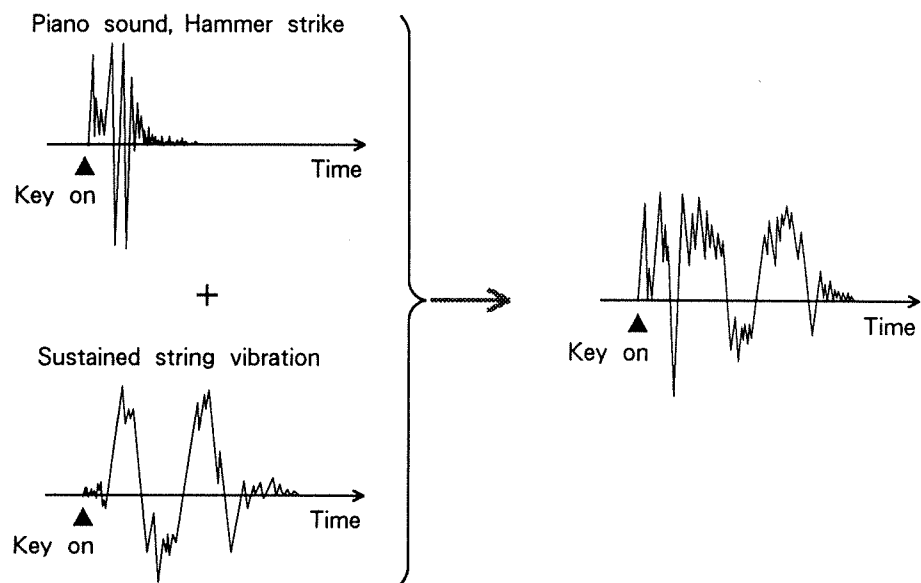

On the JD-800, you can think of a Tone as corresponding to one of these components. For example, a complex and interesting sound can be created by using one Tone to create the attack component, another Tone to create the sustain component, and combining the two Tones in a Patch. (Layered sounds : ⇨ P. III – 48).

● Adding expression

There are many ways to add expressiveness to sounds. Here are some simple examples.

○ LFO's effects

◇ Vibrato

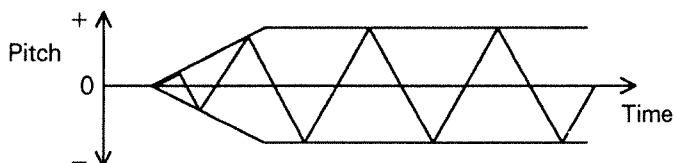

Vibrato is an effect in which the pitch is cyclically varied over time. Vibrato is often used by singers and string players to add expression. The WG parameters [LFO1 Depth, LFO2 Depth, Aftertouch Modulation, and Lever Modulation] determine the depth of vibrato (☞ II P. I - 39— I - 43).

◇ Wah-wah

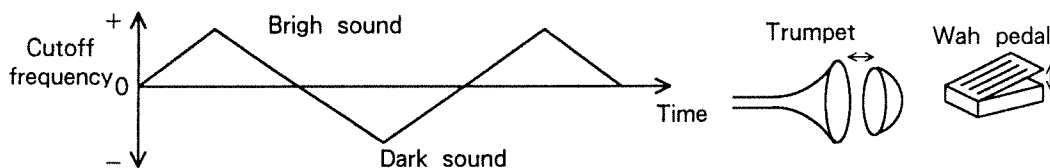

Wah-wah is an effect in which the tone color is cyclically varied over time. This effect can be produced by using a special mute with a brass instrument, or by using a wah pedal with an an electric guitar. The TVF parameters [LFO Select and LFO Depth] determine the depth of the wah-wah effect (☞ II P. I - 57、 I - 58).

◇ Tremolo

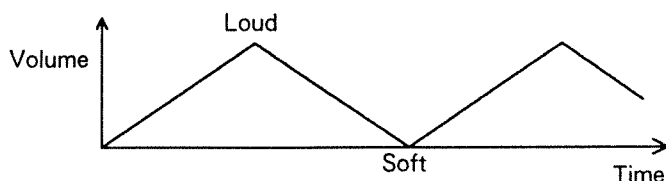

Tremolo is an effect in which the volume is cyclically varied over time. This effect is often used on electric pianos (such as the Rhodes piano). The TVA parameters [LFO Select and LFO Depth] determine the depth of tremolo (☞ II P. I - 73、 I - 74).

◇ Portamento

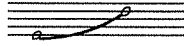

The pitch changes smoothly

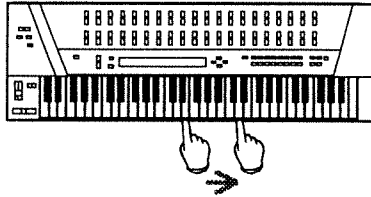

String instruments such as the violin

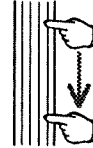

Portamento is an effect that makes the pitch change smoothly from one note to the next. This technique is often used by string players. Portamento can be created by the Patch edit Common parameters (☞ II P. I – 127、I – 128).

◇ Solo Legato

Legato playing

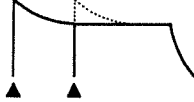

Legato is a playing technique in which successive notes are played smoothly without a break, and can be used on instruments such as violin to avoid attacks. Make settings for the Patch Common parameter Solo Legato (☞ II P. I – 125).

3. LEARNING TO CREATE SOUNDS

Effects

○ Effects

Effects can be divided into two groups; those that modify the sound itself, and those that add delay or reverb to the sound.

◇ Equalizer

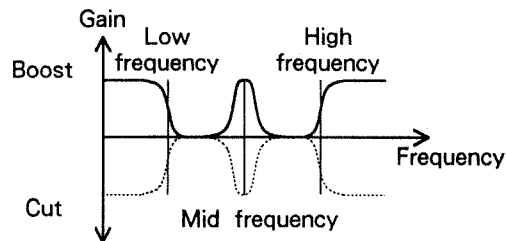

This circuitry boosts or cuts the level of specified portions of the audio spectrum to adjust the overall tone color of a sound. Equalizer settings can be made for each Patch and Special Setup. Equalizer settings for a Patch are valid in both Single mode and Multi mode (☞ II P. I – 138).

◇ Distortion

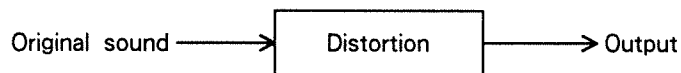

This effect distorts the sound by adding new partials, making the sound more aggressive. Settings for this effect are made in the Patch Effects parameters, and are valid only in Single mode (☞ II P. I – 95).

◇ Phaser

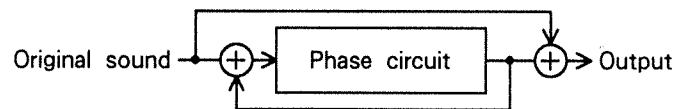

This effect mixes the original sound with an out-of-phase copy of the same sound, and cyclically varies them to create a swooshing or swirling effect. Settings for this effect are made in the Patch Effects parameters, and are valid only in Single mode (☞ II P. I – 97).

◇ Spectrum

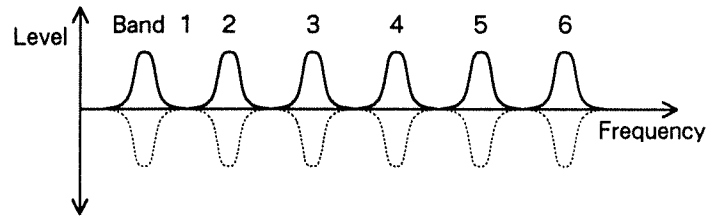

This effect is a type of filter that boosts or cuts specific frequency bands. Settings for this effect are made in the Patch Effect parameters, and are valid only in Single mode (☞ II P. I – 100).

◇ Enhancer

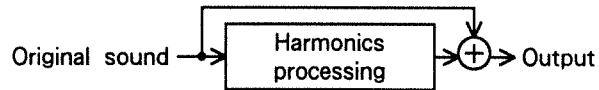

This effect adds additional harmonics to the sound, to give the sound clearer definition and make it stand out in the mix. Settings for this effect are made in the Patch Effect parameters, and are valid only in Single mode (☞ II P. I – 102).

3. LEARNING TO CREATE SOUNDS

Effects

◇ Chorus

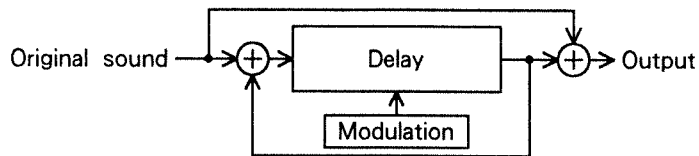

This effect mixes the original sound with a slightly pitch-shifted version of the same sound, to add depth and spaciousness. This effect is valid in both Single mode and Multi mode. However, in Single mode it is set by the Patch Effects parameters (☞ II P. I – 104), and in Multi mode it is set by the Effects parameters (☞ II P. II – 32).

◇ Delay

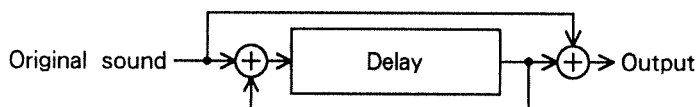

This effect adds an additional delayed sound to the original sound, creating an echo. This effect is valid in both Single mode and Multi mode. However, in Single mode it is set by the Patch Effects parameters (☞ II P. I – 107), and in Multi mode it is set by the Effects parameters (☞ II P. II – 33).

◇ Reverb

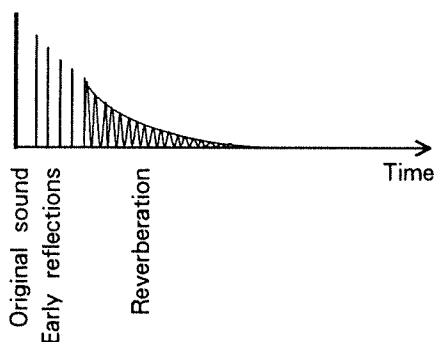

This effect adds early reflections and reverberation to the original sound, simulating the ambience of a room or hall. This effect is valid in both Single mode and Multi mode. However, in Single mode it is set by the Patch Effects parameters (☞ II P. I – 112), and in Multi mode it is set by the Effects parameters (☞ II P. II – 34).

b. Sound creating procedure

We have explained that sound has many aspects or elements (parameters). It is important to have a good understanding of these elements, but there are several additional points you must also understand in order to master the sound-creation process.

● How sound is created (understand sound generation)

Analog synthesizers of the past routed the signal through three basic circuits; VCO → VCF → VCA. On these synthesizers, you would make VCO settings to select a waveform and determine the pitch, VCF settings to adjust the filter and determine the tone color, and VCA settings to specify the volume. These three circuits form the basis of “subtractive synthesis” that we mentioned earlier.

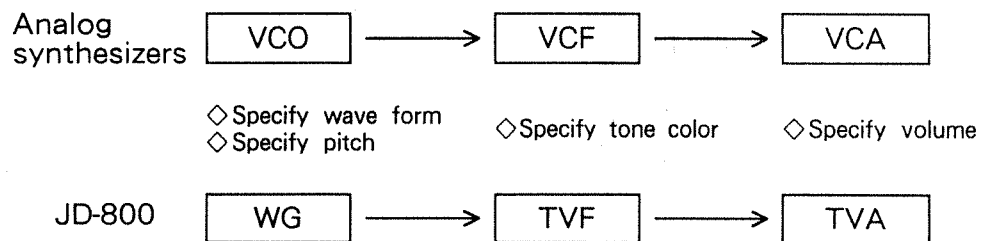

The JD-800 uses subtractive synthesis, and its signal flow of WG → TVF → TVA corresponds to the analog synthesizer's signal flow of VCO → VCF → VCA.

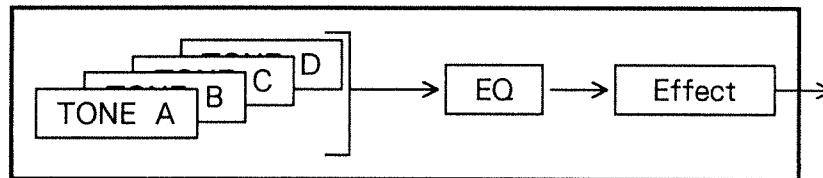

Analog synthesizers of the past used electronic circuits (VCOs) to generate the waveforms (sawtooth waves, square waves, etc.) that were the basis of the sound. Unfortunately, only a limited selection of waveforms were possible. The WG of the JD-800, on the other hand, uses waveforms that have been stored in memory (PCM waveforms), making available a much wider selection. In addition, all audio signals are processed as digital data, so that there is no deterioration of sound quality.

3. LEARNING TO CREATE SOUNDS

Sound creation procedure

● Sound creation procedure

In the first part of this chapter we explained ways in which the various elements of sound can be modified. One way is to edit an existing Patch that is close to the sound that you have in mind. One way is to edit an already existing Patch. This is probably the easiest method to use until you become familiar with editing, and is quite simple even for a beginner.

The other way is to create sounds from scratch. Before you edit the parameters, you will need to understand what each parameter does.

○ Editing an already existing Patch

Select a Patch from memory that is close to the sound that you have in mind. Use the panel controls to alter the sound of that Patch until you have what you're looking for.

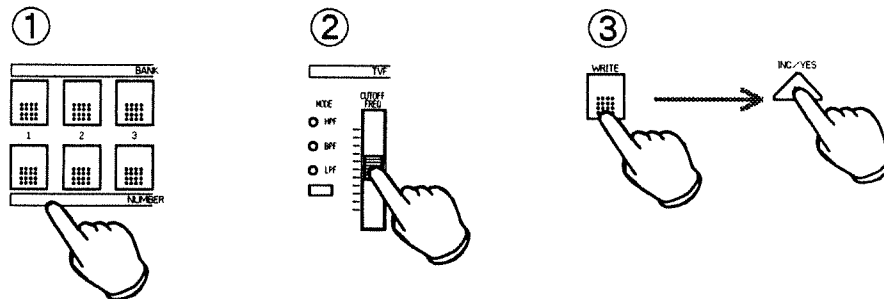

- ① Select a Patch that is close to the sound you want.
- ② Use the sliders and switches to adjust parameters as necessary to obtain the sound you want.
- ③ When you have the desired sound, write the Patch into memory (☞ P. IV – 24).

○ Setting all Patch parameters yourself

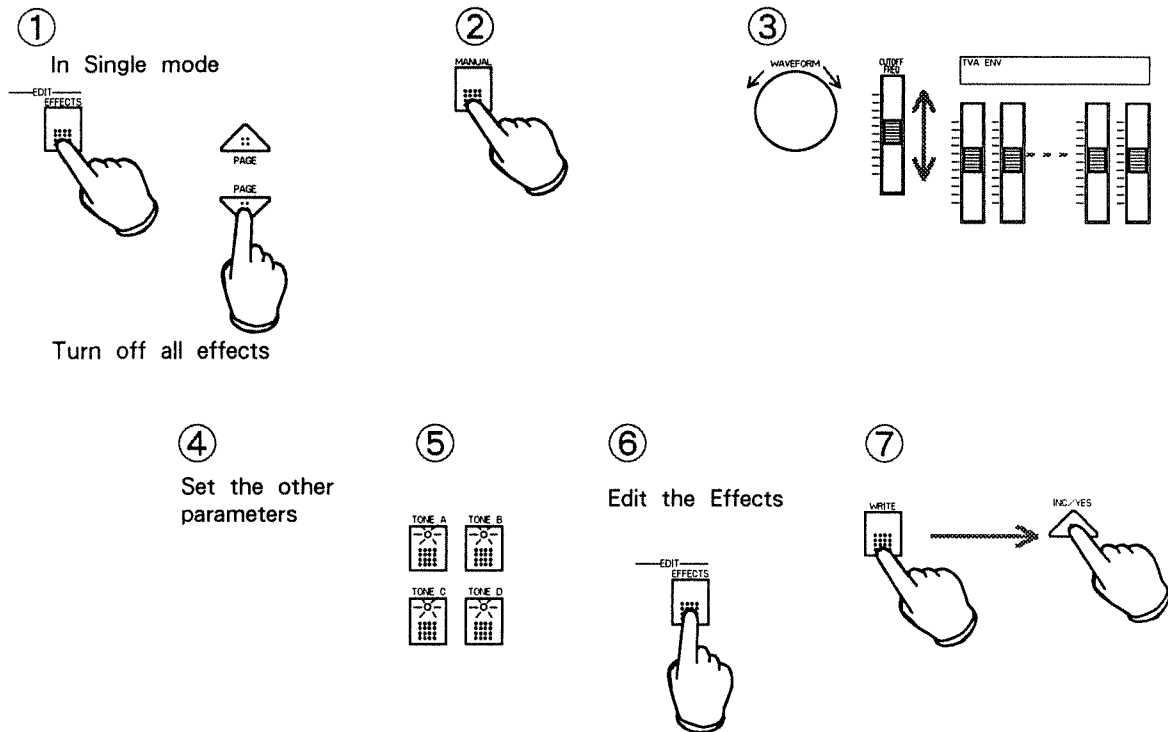

- ① Turn off all effects (☞ P. III – 18).
- ② Use the Manual operation to initialize the Tone (☞ II P. I – 12).
- ③ First select the waveform, then make filter settings (☞ P. III – 8) and TVA envelope settings (☞ P. III – 10) to approximate the sound you want.
- ④ Make fine adjustments to the other parameters as necessary to shape the Tone.
- ⑤ Create any additional Tones in the same way. Finally, mix them together (Layer: P. III – 5).
- ⑥ Use effects (☞ P. III – 18) to add the finishing touches to the Patch.
- ⑦ When you have the desired sound, write the Patch into memory (☞ P. III – 24).

3. LEARNING TO CREATE SOUNDS

Sound creation procedure

Hint

After selecting the waveform in step ③, it is easiest to make rough filter settings, then set the TVA envelope, and then make fine adjustments to the filter.

Whichever method you use, the most important thing is to have as clear an idea as possible of the sound you want to make. Then, turn that idea into actual parameter values. As you refer to the Reference Manual, keep this in mind, and try to understand the effect that each parameter will have on the sound. This will help you become a more skillful sound creator.

● Ideas for sound creation

Here are some more ideas that may help you as you edit sounds. For a more detailed explanation of each parameter, refer to the appropriate pages of the Reference Manual.

○ Modify the tone color

◇ Modify the source (waveform) of the sound

Wave number 001 : Syn Saw 1

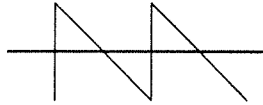

Wave number 098 : White Noise

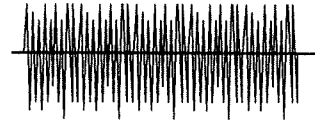

By changing the waveform (⇨ II P. I – 36), you can completely change the character of the sound.

◇ Modify the overall tone color (filter settings)

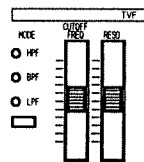

Filter Mode (⇨ II P. I – 51)

Cutoff Frequency (⇨ II P. I – 52)

Resonance (⇨ II P. I – 54)

These parameters adjust the overall tone color by determining the direction in which the harmonic spectrum will be cut, the point at which to cut, and the boost that occurs around that point.

3. LEARNING TO CREATE SOUNDS

Ideas for sound creation

◇ Modify equalizer settings

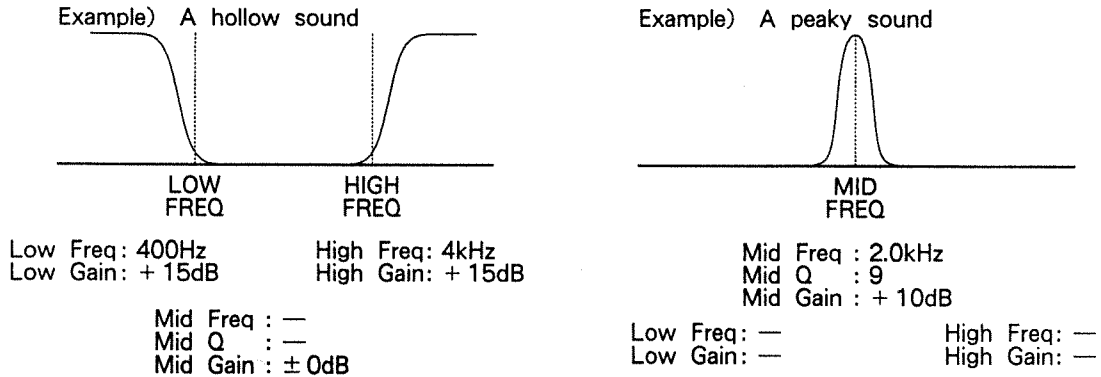

Low Frequency / Gain (☞ II P. I - 140)

Mid Frequency / Q (☞ II P. I - 141)

Mid Gain / High Frequency (☞ II P. I - 142)

High Gain (☞ II P. I - 143)

These parameters determine the points and amount by which the level will be boosted or cut. Mid Q determines the width of the center frequency band.

◇ Add effects

◇ Rearrange the order (☞ P. III - 18)

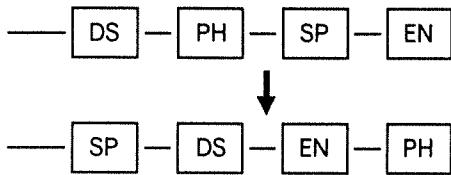

◇ Turn effects on/off (☞ P. III - 19)

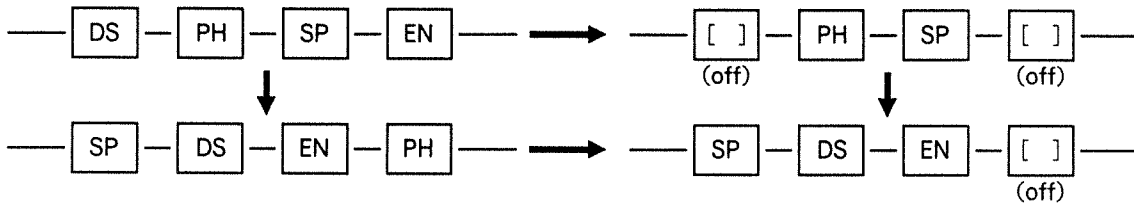

Distortion (☞ II P. I - 95)

Phaser (☞ II P. I - 97)

Enhancer (☞ II P. I - 100)

Spectrum (☞ II P. I - 102)

Effects allow you to change the character of the sound in many ways.

○ Give the sound spaciousness or depth

◇ Detune the pitch

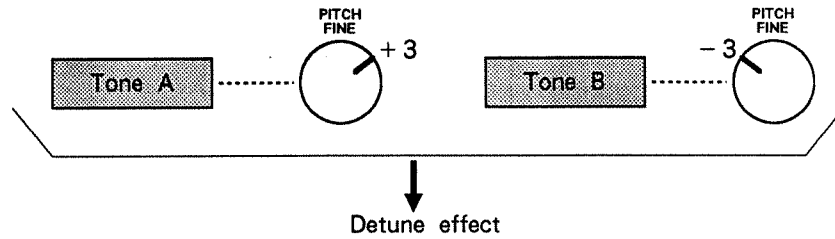

Pitch Coarse (☞ II P. I - 28)

Pitch Fine (☞ II P. I - 29)

Pitch Random (☞ II P. I - 30)

By layering two Tones and setting their pitches an octave apart (or to slightly different pitches), you can enrich the sound.

◇ Add effects

◇ Rearrange the order (☞ P.III - 18)

◇ Turn effects on/off (☞ P.III - 19)

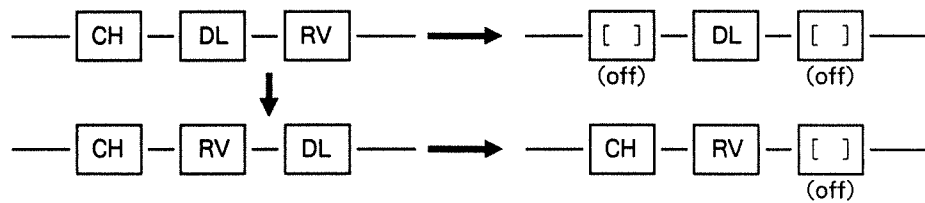

Chorus (☞ II P. I - 104)

Delay (☞ II P. I - 107)

Reverb (☞ II P. I - 112)

These effect add delay, reverb and or pitch shift to the sound to create spaciousness and depth.

3. LEARNING TO CREATE SOUNDS

Ideas for sound creation

○ Combining Tones (Layers: ⇄ II P. I – 5)

◇ Create rich sounds

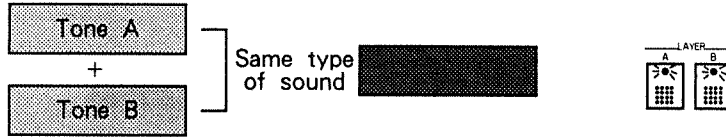

◇ Combining parts of sounds

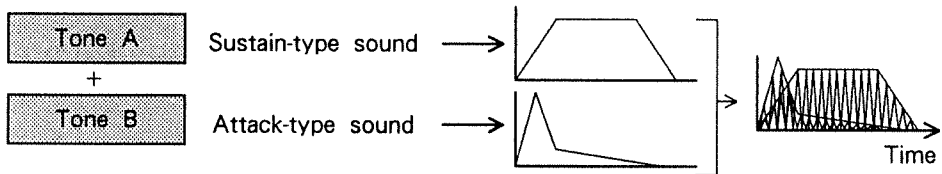

A sustain-type Tone and an attack-type Tone can be layered to create a new sound.

◇ Velocity crossfade between sounds

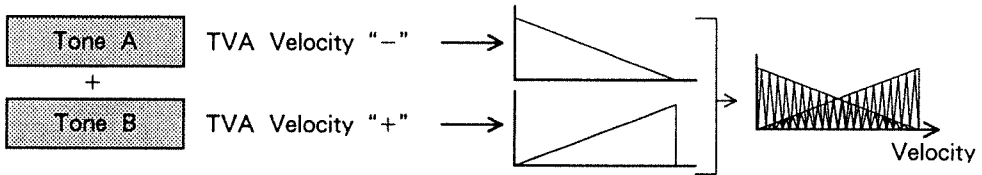

By settings the TVA ENV Velocity (⇄ II P. I – 76) of two Tones to opposite values, you can use playing dynamics to crossfade between two sounds.

◇ Gradually change the sound by keyboard position

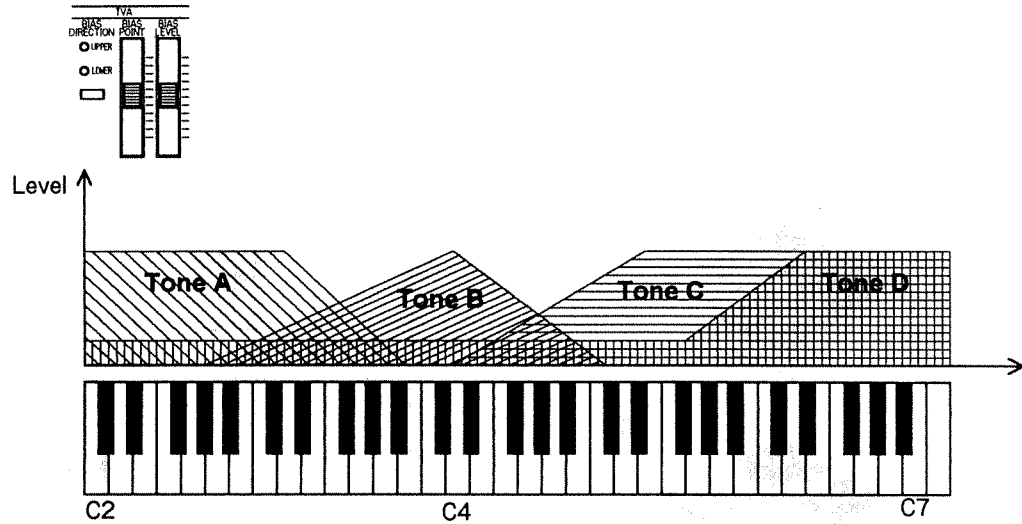

By appropriate settings of TVA Bias (☞ II P. I - 68— I - 71), you can crossfade four Tones across the keyboard.

◇ Abruptly change the sound by keyboard position

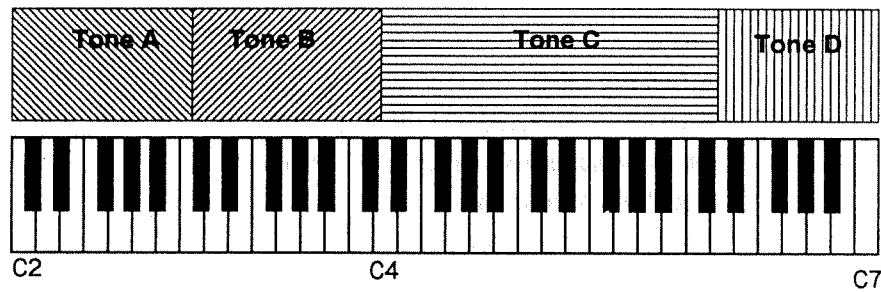

The Patch Common parameter Key Range (☞ II P. I - 120) allows you to restrict each Tone to a different area of the keyboard.

3. LEARNING TO CREATE SOUNDS

Ideas for sound creation

○ Performance techniques add variation

Velocity and aftertouch can be used to control the following parameters. In other words, the way in which you play the keyboard will affect the sound.

◇ Playing dynamics (velocity) can create change

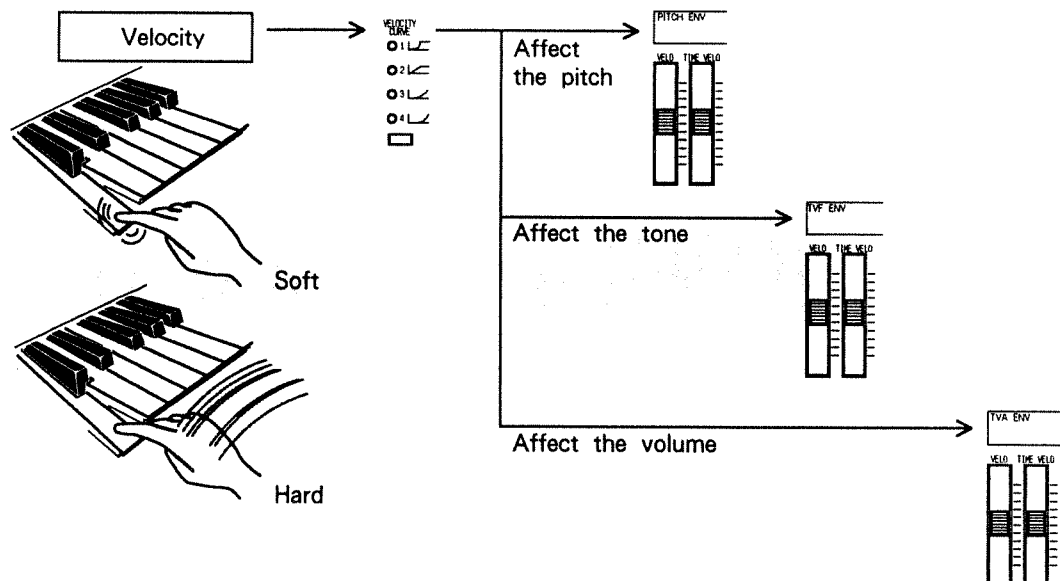

- **Affect the pitch**
 - Pitch envelope velocity (☞ II P. I – 45)
 - Pitch envelope time velocity.(☞ II P. I – 46)
- **Affect the tone color**
 - TVF envelope velocity (☞ II P. I – 61)
 - TVF envelope time velocity (☞ II P. I – 62)
- **Affect the volume**
 - TVA envelope velocity (☞ II P. I – 76)
 - TVA envelope time velocity (☞ II P. I – 77)

These parameters specify Velocity Sensitivity and Time Velocity Sensitivity for the various envelopes, to affect the way in which Pitch, Cutoff Frequency, or Level will change over time.

◇ Keyboard pressure (aftertouch) can create change

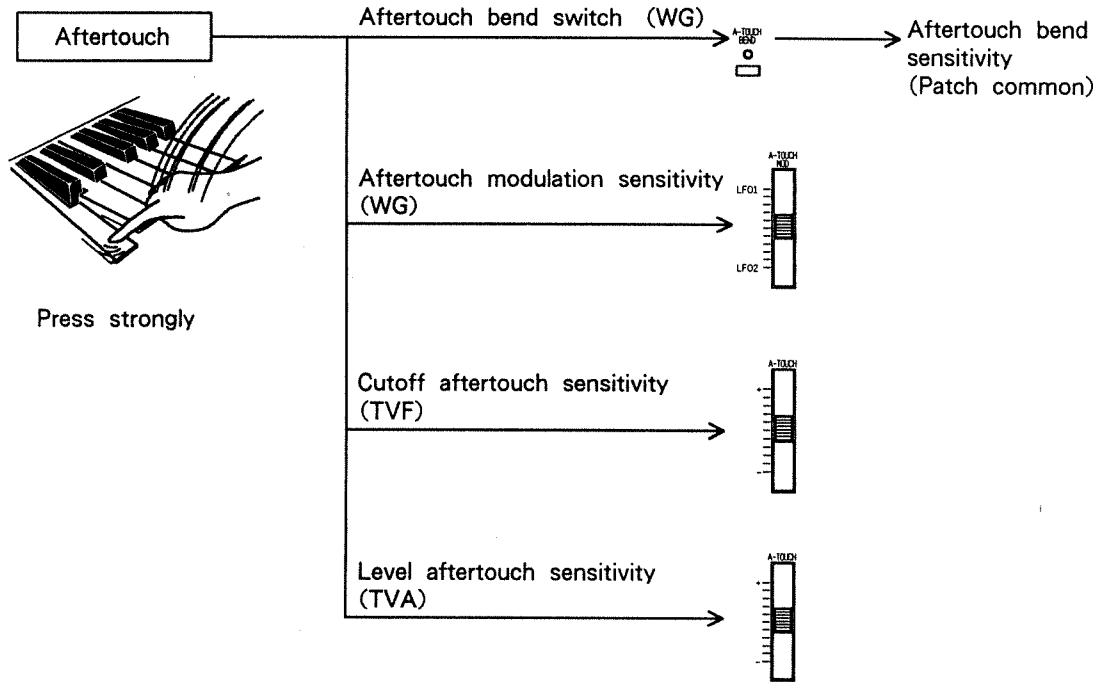

Pitch aftertouch bend (☞ II P. I - 32, I - 123)

Pitch aftertouch modulation sensitivity (☞ II P. I - 39)

Cutoff aftertouch sensitivity (☞ II P. I - 59)

Level aftertouch sensitivity (☞ II P. I - 72)

These parameters allow aftertouch to affect pitch, vibrato depth, cutoff frequency, and volume.

3. LEARNING TO CREATE SOUNDS

Ideas for sound creation

○ Keyboard position (note) can create change

◇ Pitch Key Follow (WG)

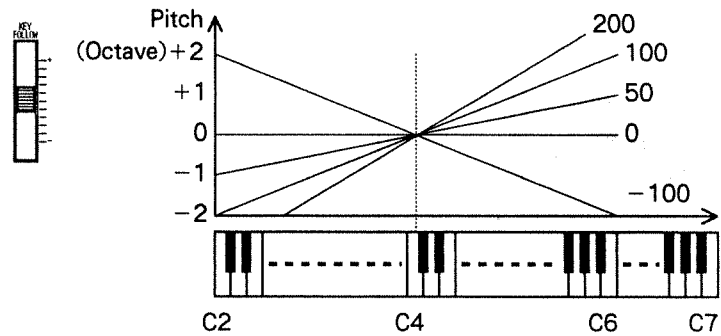

◇ Cutoff Key Follow (TVF)

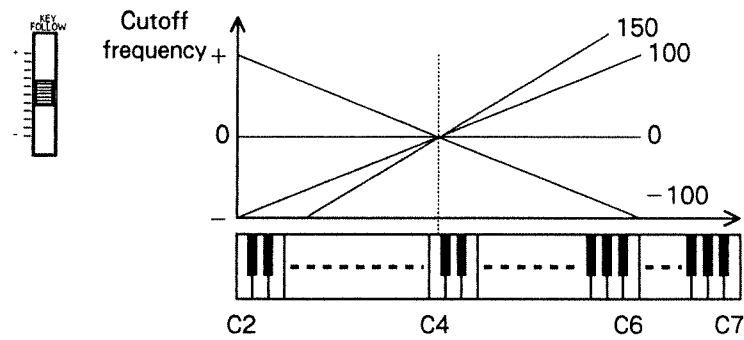

◇ Bias Level (point/direction : TVA)

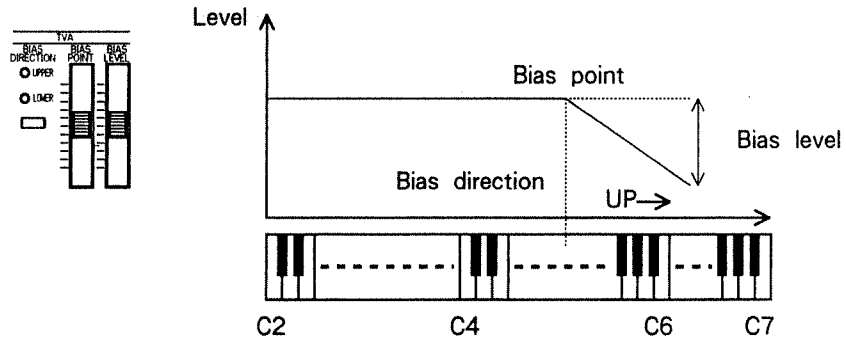

Pitch Key Follow (☞ II P. I - 31)

Cutoff Key Follow (☞ II P. I - 56)

Bias Level (☞ II P. I - 68— I - 71)

These parameters allow the keyboard position (note range) to affect pitch, cutoff point, and volume.

Chapter IV

Using the performance functions

IV

The JD-800 has a variety of functions that help you make a musical performance more expressive.

1. TUNING ADJUSTMENT

When you are playing the JD-800 together with other instruments, it may be necessary to adjust the tuning. The following procedure describes how to adjust the tuning of the JD-800 to match other instruments.

The tuning you set here applies to both Single mode and Multi mode.

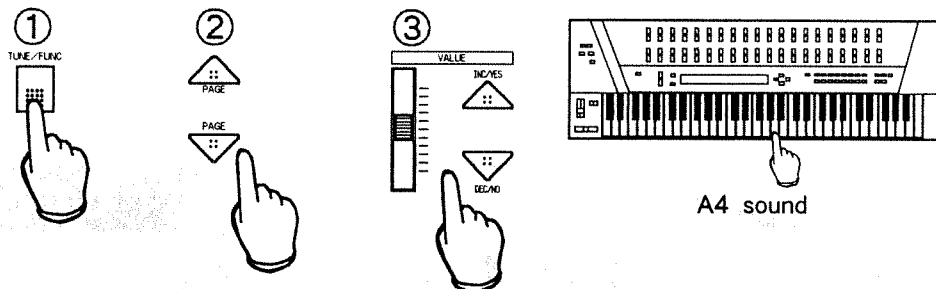

- ① Press **TUNE/FUNC**.
- ② Press PAGE **▲** **▼** to select the following display.

```
TUNE/FUNCTION
Master tune  440.0Hz
```

Blinking

The blinking number is the frequency of the A4 key (A above middle C).

- ③ Use **INC/YES** and **DEC/NO** or **VALUE** adjust the setting.

```
TUNE/FUNCTION
Master tune  440.3Hz
```

Blinking

Tuning is expressed as the pitch of the A4 key, and can be adjusted over the range of 427.5 Hz to 452.9 Hz. When shipped, A4 = 440.0 Hz.

* This value is stored even when the power is turned off.

* Internally, the value is adjusted in 1 cent steps.

Note

1 cent is 1/100th of a chromatic step (semi-tone). This means that the number of cents in 1 Hz will depend on the frequency, since a rise in pitch of one octave is actually a doubling in frequency.

From a musical standpoint, cents are usually a more convenient unit, since octaves are the basic unit of musical pitch. The tuning of the JD-800 will actually change in steps of a cent.

2. KEYBOARD-RELATED SETTINGS

● Velocity

The strength (speed) with which you play a note is called the “velocity”. By playing notes with different velocity, you can affect the pitch, tone color, or volume. The way in which these aspects of the sound will change is determined by parameters in the Tone. This means that you can make each Patch respond differently to key velocity.

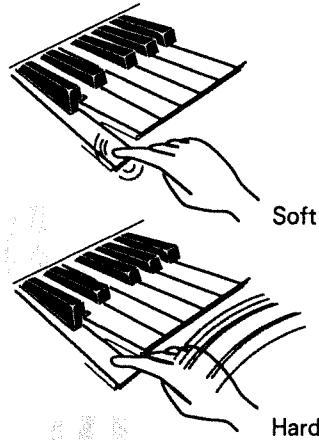

Play Patch I-11 with varying velocities, and notice how the Volume changes.

● Aftertouch

The pressure that you apply to the key after playing a note is called “aftertouch”. Aftertouch can be used to affect pitch, tone color, or volume. The way in which these aspects of the sound will change is determined by parameters in the Tone. This means that you can make each Patch respond differently to aftertouch.

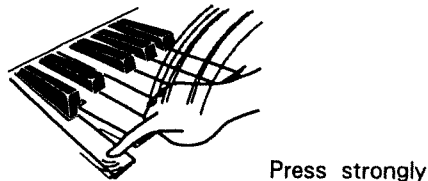

Play Patch I-52 and apply varying amounts of pressure to the keyboard, and notice how the tone color changes.

● Transpose

This function changes the range of pitches produced by the keyboard. Press **TRANSPOSE**. The indicator will light, and the keyboard will be transposed. Since you can turn this function on at any time, it may be useful during a live performance when a song changes to a new key.

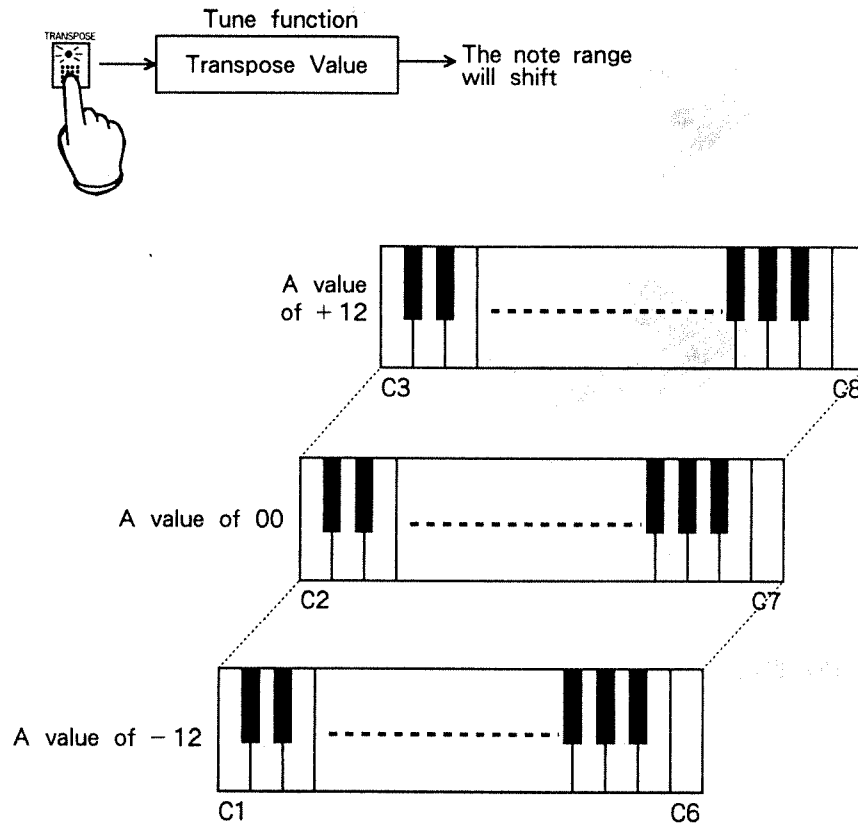

The amount of pitch shift is determined by the Transpose value settings (☞ II P. III - 6).

3. NON-KEYBOARD CONTROLS

● Bender/Modulation lever

This lever performs two functions: Pitch Bend and Modulation.

○ **Pitch Bend** As you play, move the lever to the right to raise the pitch, or to the left to lower the pitch. This function is called “Pitch Bend”. This allows you to produce effects similar to note bending on a guitar.

The pitch change that results when the lever is moved fully left or right can be specified for each Patch. Pitch bend on/off can be specified for each Tone.

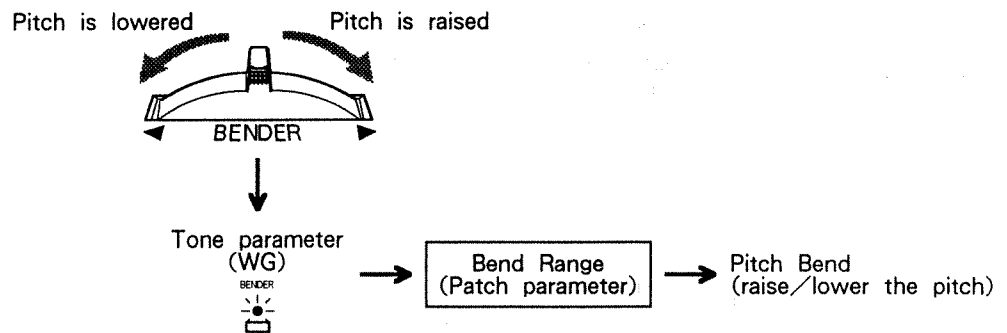

○ **Modulation** As you play, push the lever away from you to add “modulation”. When the pitch is modulated, the result is called “vibrato”. This is often used on vocal or string sounds.

The depth of the vibrato effect is determined by Tone parameters.

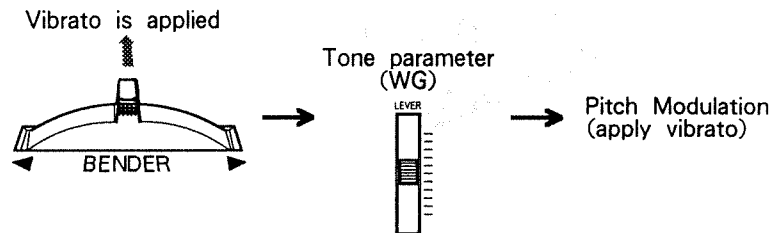

The two effects above can be set independently for each Patch and Tone, so the result will be different for each Patch you select.

3. NON-KEYBOARD CONTROLS

Hold pedal

● Hold pedal

By connecting a pedal switch (unlatched type; FS-5U, DP-2 etc.; separately sold) to the HOLD PEDAL jack (rear panel), you can sustain the sound by pressing the pedal. This effect is called “hold” and is similar to the damper pedal of a piano. In this way you can enable/disable the hold effect for each Tone.

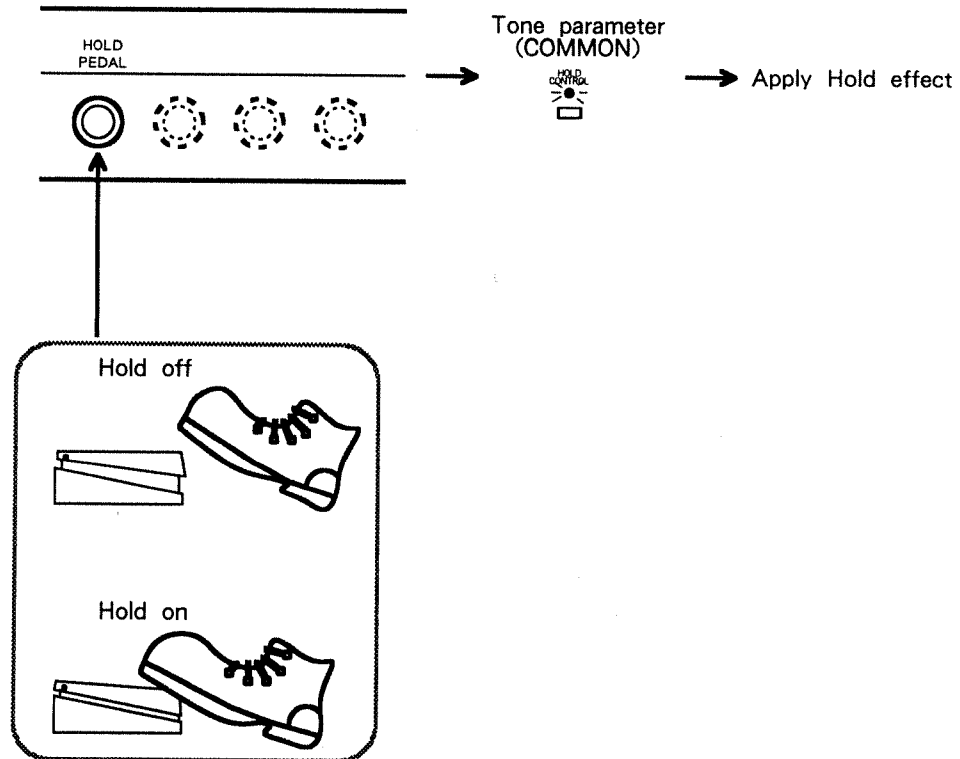

● External control

By connecting an expression pedal (EV-5, EV-10, etc.; separately sold) to the EXT CONT jack, you can control the volume or other parameters. The Tune/Function settings will determine what is controlled by the pedal. (☞ II P. III - 7)

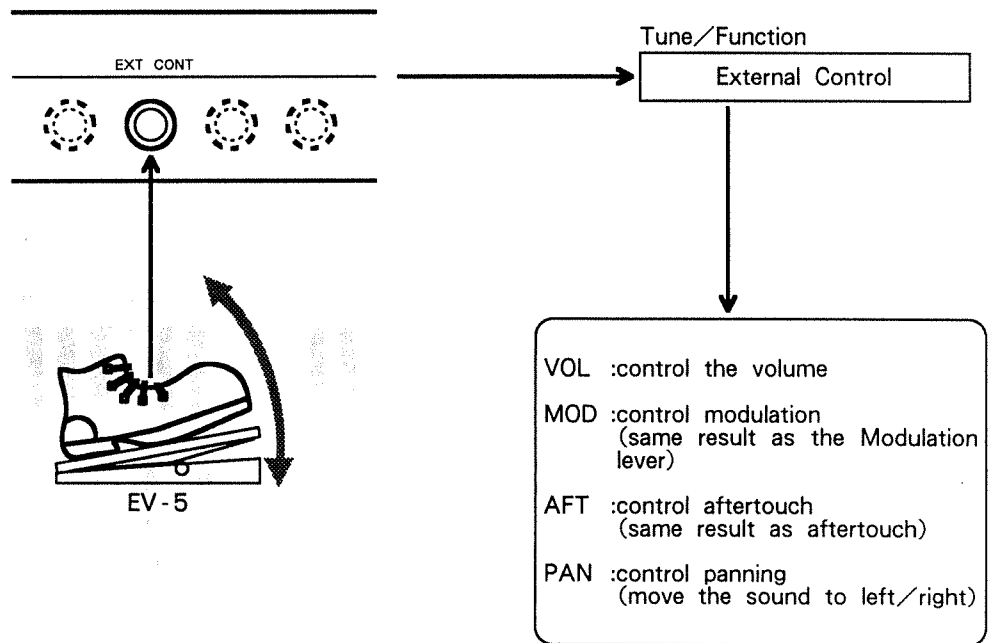

For example, by setting the pedal to AFT, you can operate the expression pedal to affect the parameter being controlled by Aftertouch.

4. PLAY IN SOLO MODE

Solo

● Solo

Solo mode allows you to play monophonic solos. Press **SOLO** and the indicator will light. Solo can be switched on/off at any time, or you can store it as part of the Patch setting.

Select and play Patch 1-24, and try out the effect of Solo mode.

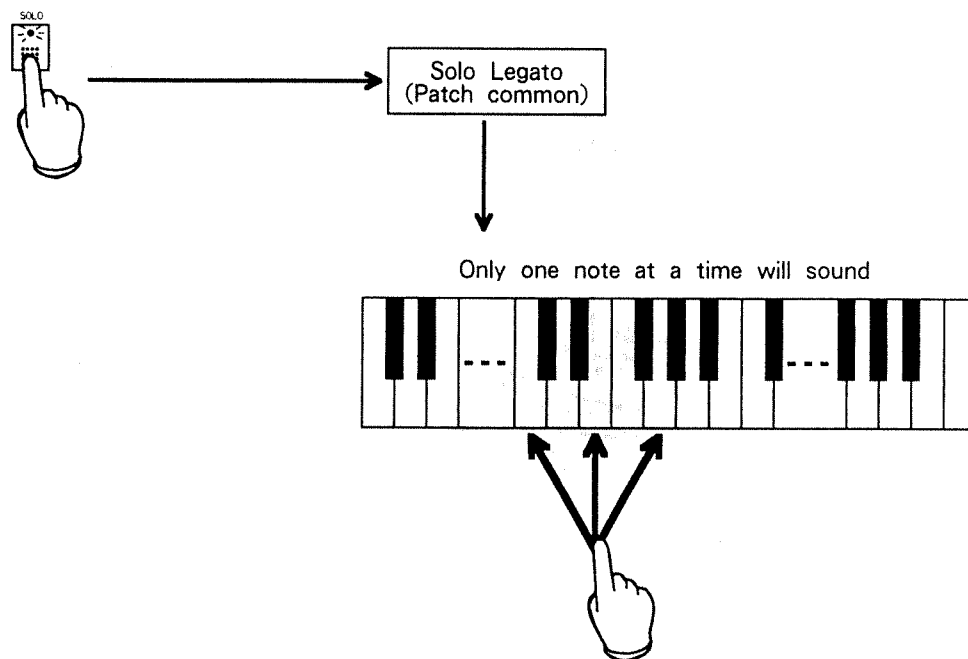

Even if you press C4, E4 and G4 simultaneously, only the note pressed last will sound.

Solo settings are part of the Patch Common parameters (☞ II P. I – 125).

*** If in Multi mode you have selected the Special Part, this effect will not apply.**

Portamento

● Portamento

If in **Solo** mode you press **PORTAMENTO**, When Portamento is on, the pitch will change smoothly between one note and the next. Portamento can be switched on/off at any time, or you can store it as part of the Patch settings.

For example select and play Patch I-14, and try out the portamento effect.

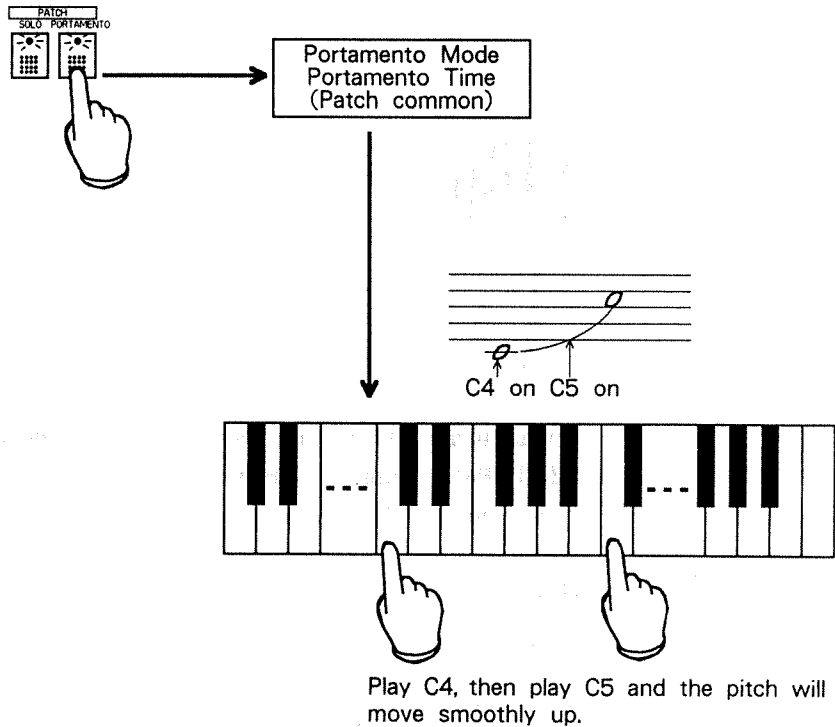

Portamento settings are part of the Patch Common parameters (☞ II P. I – 127).

*** If in Multi mode you have selected the Special Part, this effect will not apply.**

5. MODIFY THE SOUND WHILE PLAYING

● Realtime editing

It is possible to freely modify the sound even while you play. This is referred to as “realtime editing”. There are two ways to do this; using the Palette, or using the Tone parameter sliders and switches.

○ Using the PALETTE

While playing, you can move the four Tone PALETTE sliders to freely edit the parameter value of the four Tones.

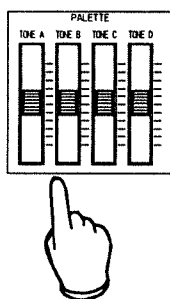

* You can also edit the parameter values of the active off tones.

* If the Patch contains Tones that are muted (☐ P. III - 5), they will not produce sound, you cannot confirm the adjustments you make here.

○ Using the sliders and switches

While playing, you can move the Tone parameter sliders and switches to modify each parameter in realtime.

For example,

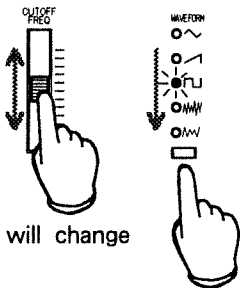

The tone color will change

The LFO waveform will change

* Only the currently active Tone will change.

* When in Multi mode you select the Special Part (manual performance), the sliders and switches will temporarily stop functioning.

6. HOW TO USE A DATA CARD

A data card can be used to store the same data as the internal memory of the JD-800. Patches and Special Setup can be stored and recalled from a data card at any time. Data cards contain a battery that preserves the memory settings. Settings that you have written into a data card can be modified or overwritten whenever you like.

● Inserting a data card

Insert the data card into the rear panel DATA slot. Refer to the diagram below, making sure to insert the card properly. Press it all the way into the slot.

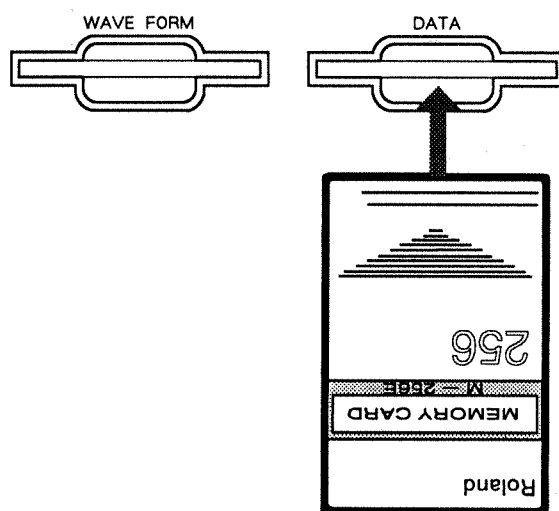

- * Please use only the M-256E memory card (sold separately). No other type of memory card can be used.
- * When you purchase a new data card (M-256E), the battery is not installed. Follow the instructions enclosed with the card, and install the battery (CR-2016) before you initialize the card.

● Initializing a data card

Before a newly purchased data card (M-256E) can be used, it must be prepared to accept JD-800 data. This procedure is called "initializing".

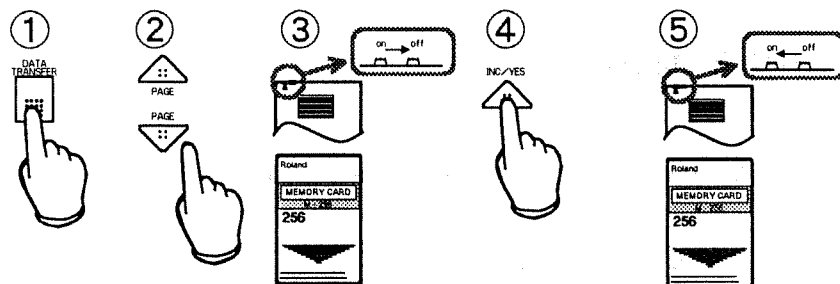

- ① Press **DATA TRANSFER**.
- ② Press **PAGE** **▲** **▼** until the following display appears.

```
DATA intialize
                ? [Y/N]
```

- ③ Set the protect switch of the data card to "off".
- ④ Press **INC/YES** and the following display will appear, and you will return to the previous play mode.

```
DATA intialize
                Completed
```

- ⑤ Set the protect switch of the data back to "on".

***The protect switch on the data card allows you to prevent important data from being accidentally overwritten. Normally you should leave this "on", and set it "off" only when you need to write data into the card.**

● Using a data card

This section will explain how to use a data card.

○ Selecting data from a data card

Here's how to select Patches or Special Setups stored on a card.

◇ Selecting a Patch

You can directly select a Patch that has been stored on a card.

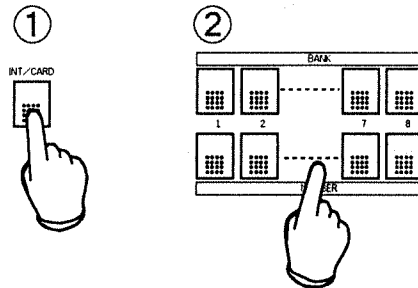

① Press **INT/CARD**.

② In the same way as when selecting an internal Patch, press **BANK** **1**—**8** and **NUMBER** **1**—**8**.

SINGLE 077 CH:01	TVA:Level
C-25:Stratocaster	*100 100 100 100

* This procedure can be used in both Single mode and Multi mode.

6. HOW TO USE A DATA CARD

Selecting data from a data card

◇ Selecting a Special Setup

You can copy a Special Setup from a card into the temporary area of the internal memory.

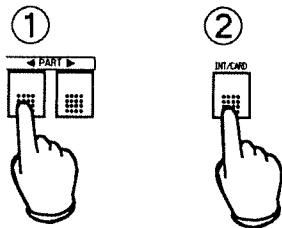

① In Multi mode, select the Special Part (→ P. II – 11).

② Press **INT/CARD**.

```
MULTI Parts 002 CH:10  
CARD Setup
```

The setup data saved on the card has now been copied into the internal temporary area.

* Press **INT/CARD** once again, and you can play the original (internal) Special Setup.

○ **Save data** Patch and Setup data that you edited can be saved to a card.

◇ **Save a Patch** Here's how to save an edited Patch to a card.

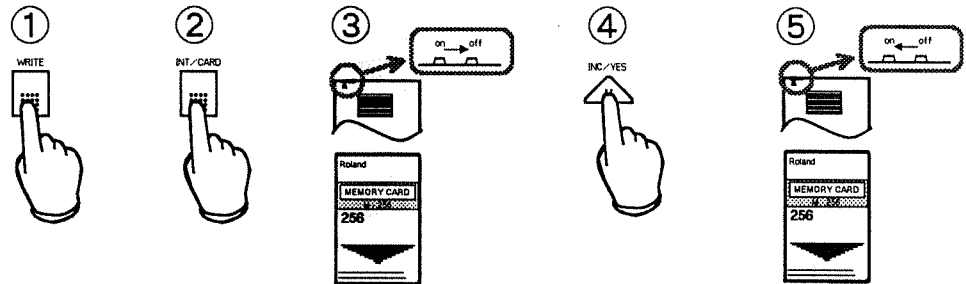

① While editing the Patch or Tone, press **WRITE**.

② Press **INT/CARD**. The blinking " I " will change to " C ". Now you can write the data to the card.

```
WRITE from TMP
to C-11 ?      [Y/N]
```

③ Set the data card protect switch to "off".

④ Press **INC/YES**, and the Patch will be written into the card memory of the same number.

```
WRITE from TMP
to C-11      Completed
```

⑤ Set the data card protect switch back to "on".

*To save the entire set of all internal Patches (I-11—I-88) to a card, use the Data Transfer operation (☐ II P. IV - 4).

6. HOW TO USE A DATA CARD

Special Setup Write

◇ Save a Special Setup

Here's how to save an edited setup to a card.

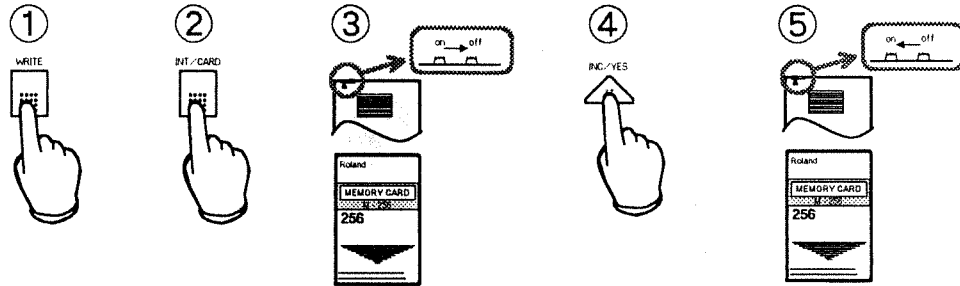

- ① While in Multi mode when you are editing the special setup, press **WRITE**.
- ② Press **INT/CARD**. The "INT" in the display will change to "CRD". Now you can write the data to the card.

```
WRITE SPECIAL Setup  
to CRD ?           [Y/N]
```

- ③ Set the data card protect switch to "off".
- ④ Press **INC/YES**, and the data will be written to the card.

```
WRITE SPECIAL Setup  
to CRD           Completed
```

- ⑤ Set the data card protect switch back to "on".

Chapter V

About MIDI

V

1. WHAT IS MIDI?

MIDI (Musical Instrument Digital Interface) is a world-wide standard that provides a way for electronic musical instruments to communicate.

Nearly all electronic musical instruments sold today have MIDI connectors. Instruments that have MIDI connectors can be connected to any other MIDI device (regardless of the manufacturer or model) and exchange musical data.

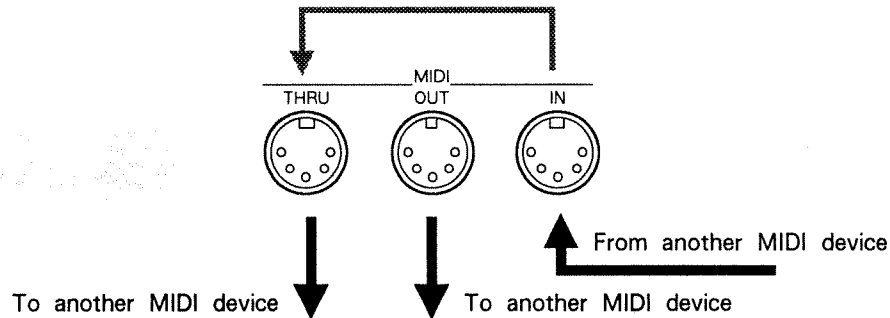

● MIDI connections

This section will explain how to use the three connectors located on the rear panel of the JD-800; MIDI IN/OUT/THRU. The simplest type of connection is as shown in the diagram below. In this setup, playing the keyboard of the JD-800 will make the other device sound as well. In this type of one-way connection, the transmitting device is called the “master” and the receiving device is called the “slave”.

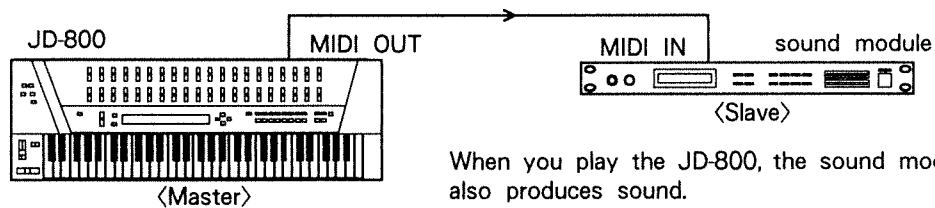

When you play the JD-800, the sound module also produces sound.

MIDI connections

If you have a sequencer (MC-50, etc.), make connections as shown in the diagram below. This setup allows you to record musical data into the sequencer by playing the keyboard of the JD-800. If the sequencer has a Soft Thru setting (☐ P. V - 16), turn it "on", and set the JD-800 Local Control (☐ P. V - 32) to "off". If the sequencer does not have a Soft Thru setting, set the JD-800 Local Control "on".

This is also a type of one-way setup, but the JD-800 will act as the master when recording, and the sequencer will act as the master during playback.

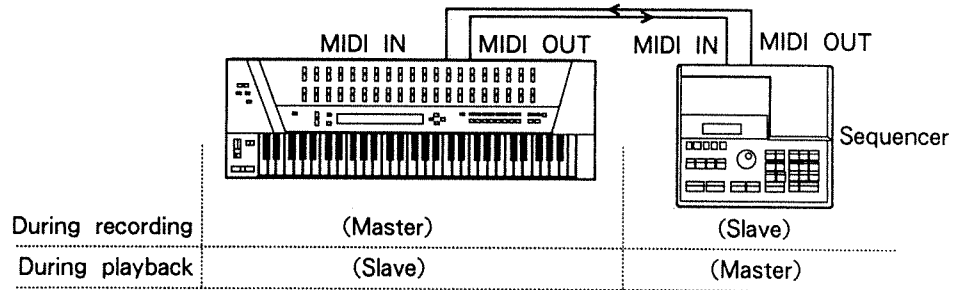

If you wish to play two or more external sound sources (synthesizers, sound source modules, etc.) at once, use the MIDI THRU connectors to connect the slave units as shown below. This type of "series" connection allows the musical data transmitted by the JD-800 to be received by two or more slave units. However, the MIDI signal will begin to deteriorate if it passes through too many MIDI THRU connectors. If you need to connect four or more slave units, it is best to use a MIDI patch bay (A-880: sold separately) to connect the units in a "star" configuration.

<Series connection>

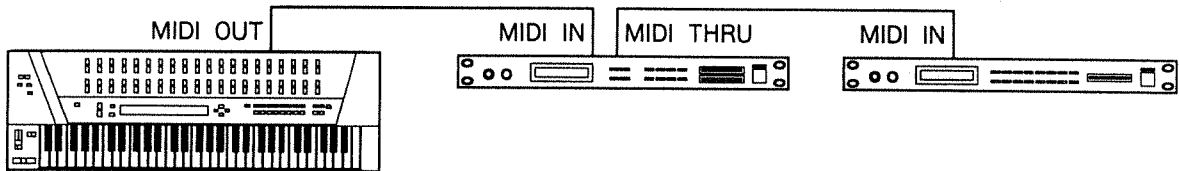

<Star configuration>

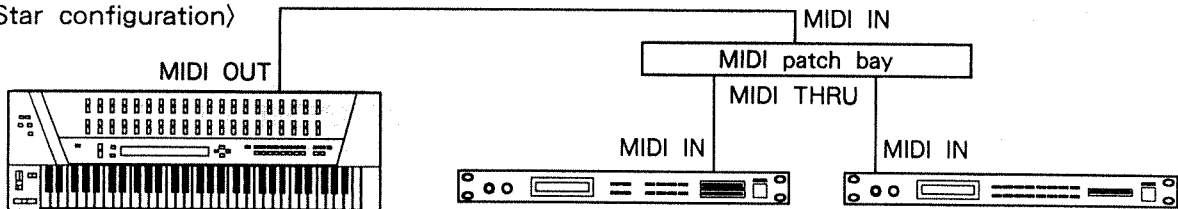

1. WHAT IS MIDI?

MIDI channels

● MIDI channels

MIDI uses “channels” to provide independent control over many devices through a single cable. You can think of MIDI channels as being similar to television channels. Electrical signals come into a television set (from the antenna) on many different channels at once. However, only the channel to which the TV set is tuned will be received.

This is similar to the situation when a sequencer is sending MIDI data to the JD-800. Each channel of MIDI data can be compared to a TV broadcast station, and the JD-800 to the TV receiver. The sequencer is transmitting data of many channels, but the JD-800 will receive only the specified channel of data.

A major difference, however, is that the JD-800 is able to function as six independent sound sources. This means it can simultaneously receive six different channels of data to play these sound sources independently. This is what is known as a “multi-timbral” synthesizer.

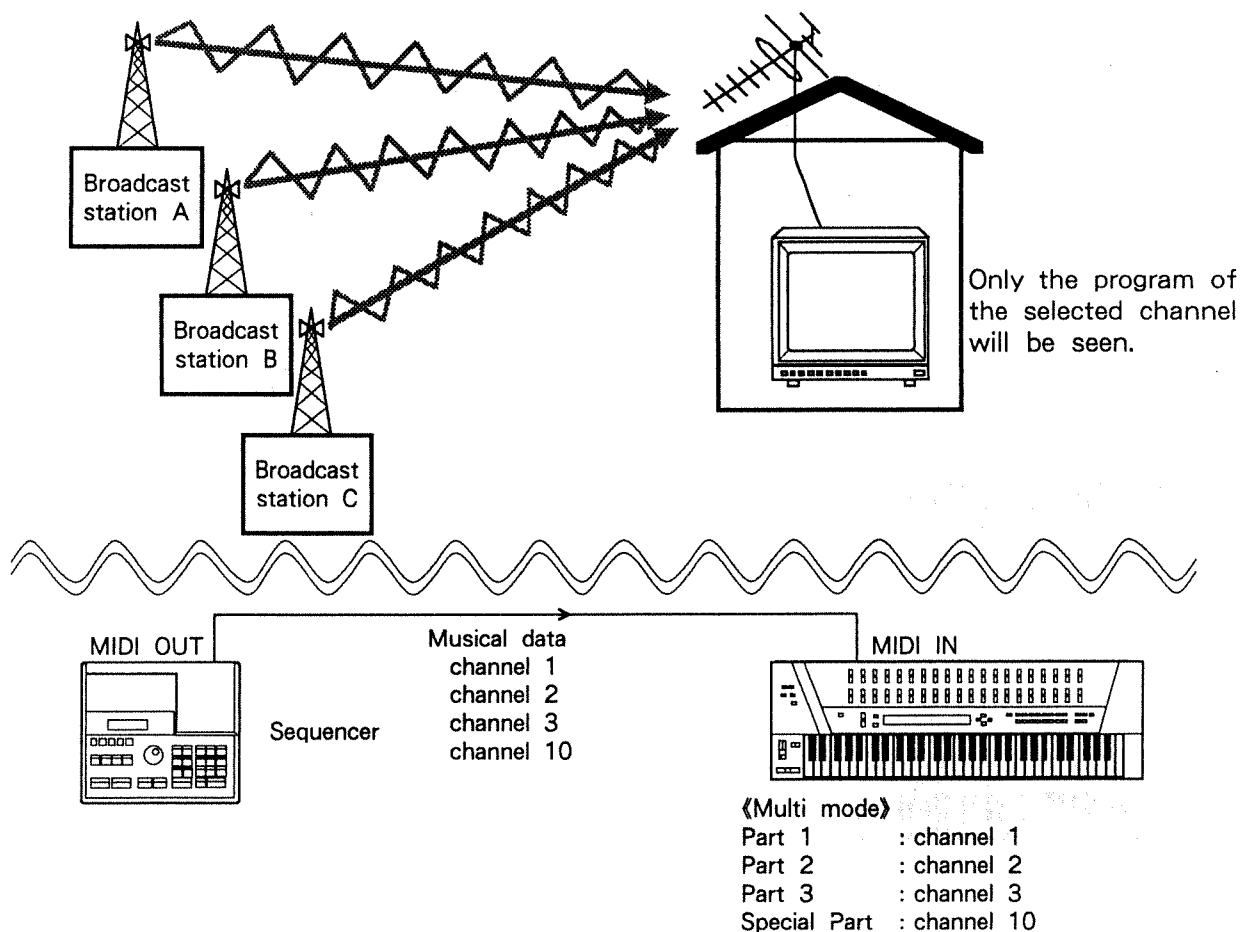

Each Part will be played by a different channel of data.

2. MIDI MESSAGES

The various types of data transmitted and received via MIDI are called MIDI messages. MIDI messages can be broadly divided into Channel messages and System messages.

Channel messages carry a channel number, and can be subdivided into Voice messages and Mode messages.

System messages do not carry a channel number, and can be subdivided into Realtime messages, Common messages, and Exclusive messages.

This section will explain the various types of MIDI messages used by the JD-800. For details, refer to MIDI Implementation (☞ II P. V – 53).

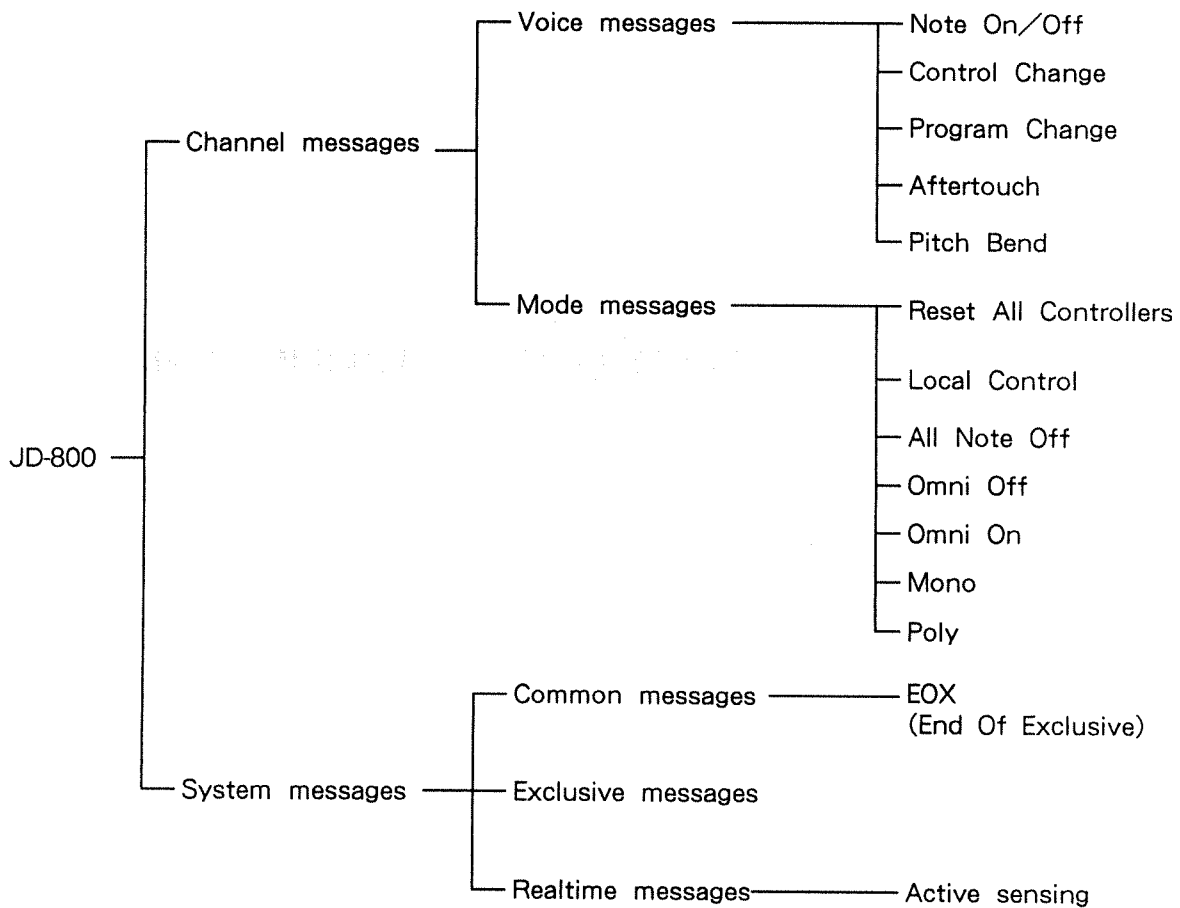

a. Channel messages

● Voice messages

Voice Messages make up the greater part of MIDI messages. When you play a MIDI instrument, these messages are normally transmitted from MIDI OUT, and are also sent to the internal sound source to make it produce sound.

○ Note messages

Note messages are transmitted when you play the keyboard. Each message contains information telling which key was pressed (the note number) and how strongly (the velocity) it was pressed or released (note on/off).

Notes are numbered from 0—127, with middle C (C4) as 60.

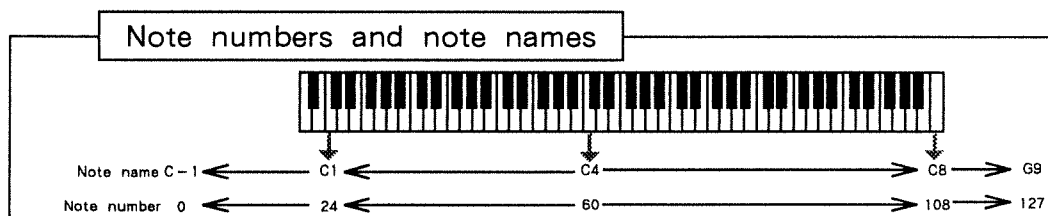

The JD-800 is able to transmit note numbers 24 (C1) through 108 (C8), but is able to receive note numbers 0 (C - 1) through 127 (G9).

○ Aftertouch messages

Aftertouch messages are transmitted when you press down on the key after playing a note. By varying this pressure, you can control a variety of parameters for the internal sound source.

There are two types of aftertouch. Channel Aftertouch is transmitted as a single value for the entire keyboard, and Polyphonic Aftertouch is transmitted independently for each key. The JD-800 transmits and receives only Channel Aftertouch.

○ Pitch Bend messages

Pitch Bend messages are transmitted when you move the BENDER lever. Each message tells the current position of the lever. The internal sound source of the JD-800 will modify the pitch in response to these messages.

○ Program Change messages

Program Change messages are transmitted when you press the front panel **INT/CARD**, **BANK** [1]—[8], and **NUMBER** [1]—[8] buttons. These messages are received by the internal sound source of the JD-800 to select Patches, and by external devices to select sounds or programs.

JD-800 program numbers and MIDI program numbers

		NUMBER										NUMBER							
		1	2	3	4	5	6	7	8			1	2	3	4	5	6	7	8
BANK	1	1	2	3	4	5	6	7	8	BANK	1	65	66	67	68	69	70	71	72
	2	9	10	11	12	13	14	15	16		2	73	74	75	76	77	78	79	80
	3	17	18	19	20	21	22	23	24		3	81	82	83	84	85	86	87	88
	4	25	26	27	28	29	30	31	32		4	89	90	91	92	93	94	95	96
	5	33	34	35	36	37	38	39	40		5	97	98	99	100	101	102	103	104
	6	41	42	43	44	45	46	47	48		6	105	106	107	108	109	110	111	112
	7	49	50	51	52	53	54	55	56		7	113	114	115	116	117	118	119	120
	8	57	58	59	60	61	62	63	64		8	121	122	123	124	125	126	127	128

Internal (INT) Card (CARD)

*The above table shows the Program Change numbers that are transmitted when the MIDI Tx Program Chg (☐ II P. III – 16) is set to “NORMAL”. If this parameter is set to “PATCH”, the Tx PC# (☐ II P. I – 136) you specify for each Patch will determine the MIDI Program Change numbers that are transmitted.

*When a Program Change message is received, a Patch will be selected as shown in the above table.

*When you select a Patch, the received Program Change number for that Patch will be shown in the display.

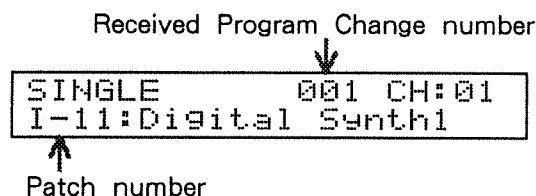

○ Control Change messages

Control Change messages are transmitted when you move a controller (modulation lever, hold pedal, external controller, etc.). Control Change messages carry a control number to indicate the function they are intended to control. The internal sound source of the JD-800 can receive these messages to control parameters such as vibrato, hold, volume, and pan.

● Mode messages

These messages determine how a MIDI device functions and how it will receive MIDI data.

○ Reset All Controllers

This message tells the receiving device to immediately reset all of its controllers (bender, modulation, etc.) to their normal values. When the Single/Multi mode is changed, this is the last message transmitted on that channel before switching to the new channel.

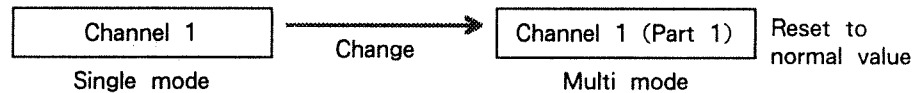

If the MIDI transmit channel is changed while bender or modulation is being applied, the receiving device will never receive the message that tells a controller to return to normal; i.e., the pitch will hang, or a controller will be “stuck”. To prevent this, the Reset All Controllers message is transmitted.

○ Local Control

This message tells the receiving device to disconnect its controller section (keyboard, etc.) from its sound source. This message is only received, not transmitted. The MIDI parameter settings (P. V – 32) will determine whether or not it is received.

When Local is “on”, the controller section will be connected to the sound source, and notes played on the keyboard will trigger the sound generator. When Local is “off”, the controller section will be disconnected from the sound source, and notes played on the keyboard will not trigger the sound generator.

The sound generator section will produce sound in response to incoming messages from MIDI IN, regardless of the Local Control setting.

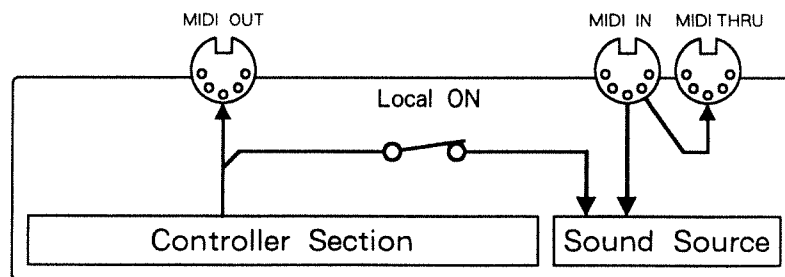

It is convenient to turn Local "off" when you are using the JD-800 as a master keyboard and do not want to use the internal sound source, or when you want to control the JD-800's internal sound source with an external keyboard.

- ◇ Play only the external sound source (use as a master keyboard)

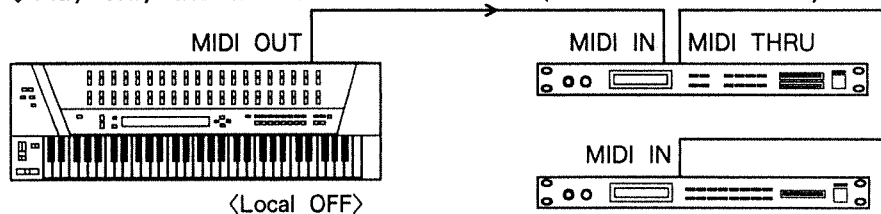

- ◇ Play only the internal sound source

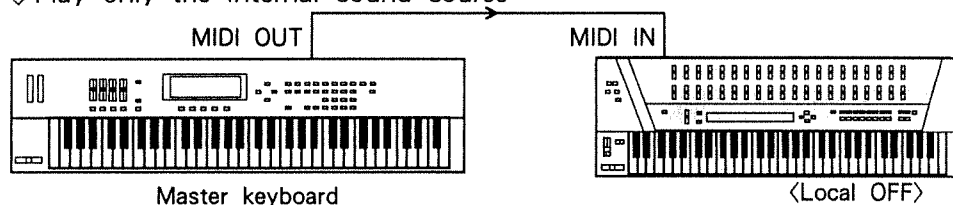

When using a sequencer, turn the sequencer's Soft Thru "on" and set the JD-800 to Local "off". This will ensure that the JD-800's internal sound source is not played twice by the same note (which could otherwise result in notes being cut off).

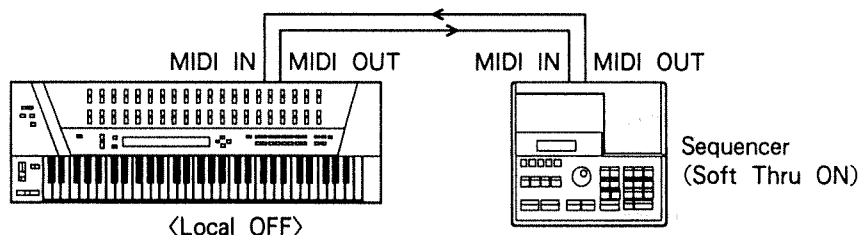

○ All Note Off

This message tells the receiving device to turn off (release) all currently sounding notes. This message is received only.

*** This has no effect on notes being played from the JD-800's keyboard.**

○ Omni mode

This message tells the receiving device how to receive MIDI channel messages.

When Omni is "off", only the messages that arrive on the specified channel will be received. When you turn the power on or change between Single mode and Multi mode, this message will be transmitted on the channel you are about to use. When Omni off message is received, it will be processed as an All Note Off message.

When Omni is "on", the messages of all channels will be received, regardless of the specified receive channel. Omni off message is received only, and will be processed as an All Note Off message.

*** The JD-800 will not switch Omni on/off.**

2. MIDI MESSAGES

Mode messages

○ Mono/Poly These messages tell the receiving device whether to produce only one note at a time (mono), or up to as many notes as it is able (poly).

When an instrument is set to Mono, it will produce only one note at a time, regardless of how many keys are pressed.

When an instrument is set to Poly, you will be able to play chords. When you turn the power on or change between Single mode and Multi mode, this message will be transmitted on the transmit channel you are about to use.

When either Mono or Poly messages are received, the JD - 800 will interpret them as All Note Off messages.

***The JD-800 will not switch Mono/Poly.**

More about Modes

When the above two mode messages (Omni On/Off and Mono/Poly) are combined, there are a total of four possibilities.

Mode 1 (omni on, poly):

The instrument will receive notes on any channel, and play polyphonically (i.e., it will produce as many notes as requested, up to the limit of its capacity).

Mode 2 (omni on, mono):

The instrument will receive notes on any channel, and play monophonically (i.e., it will produce only one note at a time).

Mode 3 (omni off, poly):

The instrument will receive notes only on the specified channel, and play polyphonically.

Mode 4 (omni off, mono):

The instrument will receive notes only on the specified channel, and play monophonically.

These modes affect reception only; i.e., there is no such thing as transmitting in omni mode, or transmitting in poly or mono mode.

Normally, the JD-800 will receive data in mode 3, but when you press **SOLO** it will receive data in mode 4.

b. System messages

These messages affect an entire device. Of this group of messages, only the Realtime message Active Sensing and the Common message EOX (end of Exclusive) are meaningful to the JD-800, so the other types of message will not be explained here.

● Realtime messages

○ Active Sensing

The JD-800 transmits these messages (from MIDI OUT) at intervals of approximately 250 msec, to allow the receiving device to monitor the integrity of the MIDI connection.

If a device is connected to the JD-800's MIDI IN, and if the JD-800 receives an Active Sensing message, it will expect to continue receiving such messages. If messages (Active Sensing or any other messages) are not received within 400 ms of each other, the JD-800 is programmed to turn off all currently sounding notes received at MIDI IN. All controllers will be reset just as if a Reset All Controller message was received. Further monitoring of incoming messages will be discontinued.

● Common messages

○ EOX (end of Exclusive)

This message indicates the end of an Exclusive message (explained below).

● Exclusive messages

Exclusive messages contain data that is unique to a specific family of devices made by a manufacturer, and are used to transfer sound data, etc.

Although MIDI is a world-wide standard, to limit the messages only to those that can be exchanged between all devices would mean that data unique to a manufacturer or device could not be transferred via MIDI. For this reason, the Exclusive message was devised as a means by which manufacturers could define their own data formats and transfer their own unique data.

The JD-800 can transmit Exclusive messages to record Patch or Setup data into a sequencer or other data storage device. This data can then be played back later and transmitted back to the JD-800. For details, refer to "Exclusive Communications" (☞ II P. V – 58).

2. MIDI MESSAGES

MIDI implementation chart

● About MIDI implementation charts

MIDI allows a wide variety of devices to exchange information, but it is not necessarily the case that all types of messages can be transmitted or received by every device.

For example, if a keyboard that is able to transmit Aftertouch messages is connected to a sound module that is not able to receive Aftertouch messages, the Aftertouch messages transmitted by the keyboard will have no effect. For MIDI messages to be effective, they must be transmitted by one device and received by the other.

For this reason, a "MIDI Implementation Chart" is included with every MIDI device, usually in the operation manual. By comparing the charts of two devices, you can determine how messages will be exchanged between them. Since the charts are a standard size, you can fold the charts of the two devices together as shown below.

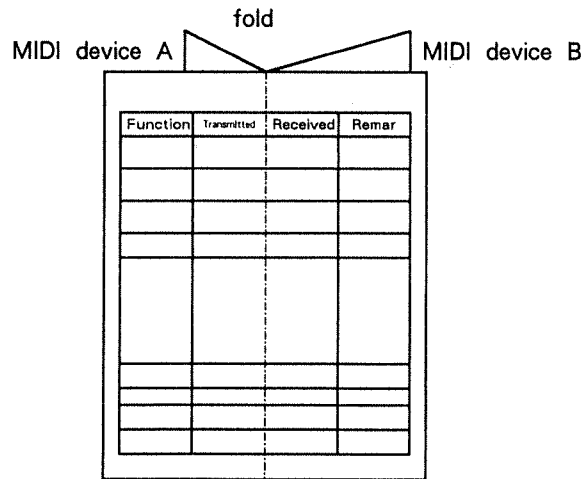

* For details of MIDI messages, refer to "Roland Exclusive Messages" (☞ II P. V - 51) and "MIDI Implementation" (☞ II P. V - 53).

3. TAKING ADVANTAGE OF MIDI

By connecting the JD-800 to other MIDI devices, you can take advantage of the many functions we have explained in the previous pages. Here we'll give examples of using the JD-800 in Single and in Multi mode.

a. Using MIDI in Single mode

When the JD-800 is in Single mode, its sound source will function as a single instrument, controlled by the controller section (keyboard and bender lever, etc.).

The following diagram shows the flow of MIDI messages. The data from the controller section is transmitted from MIDI OUT on the MIDI channel specified by the MIDI Tx Ch setting (P. V - 27), and also sent through the Local Control On/Off setting to the internal sound source (Patch).

The internal sound source also produces sound in response to messages received from MIDI IN.

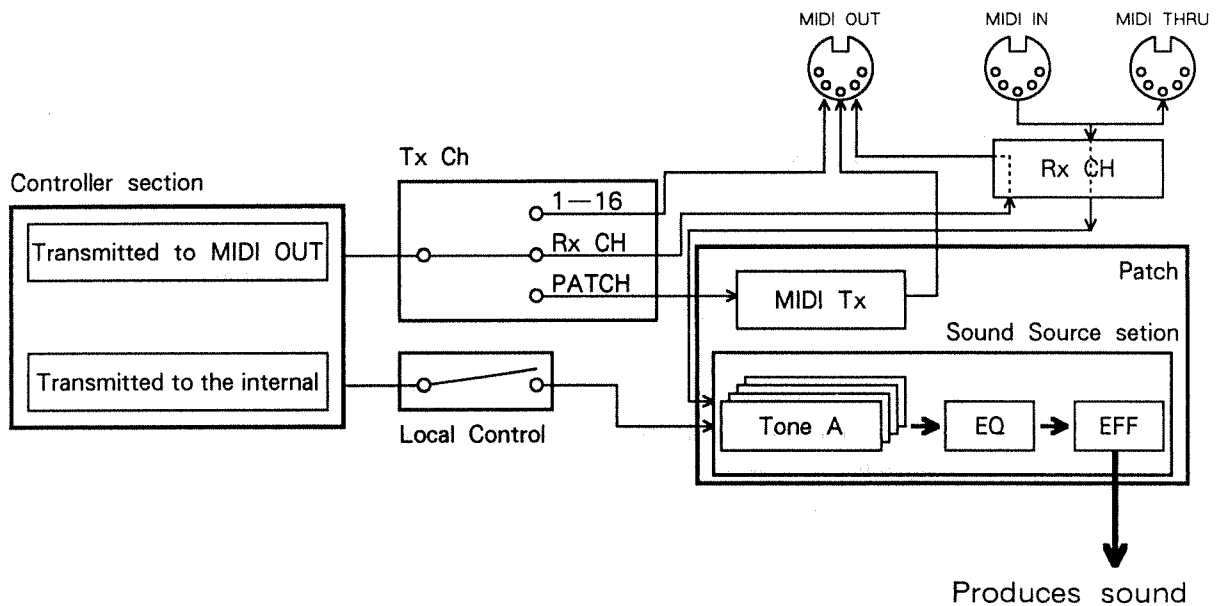

● Connecting an external sound module

To use the JD-800 as a master keyboard and play an external sound module, make connections as described here.

○ To play only the external sound module

Here's how to play the external sound module, without playing the JD-800's internal sound source.

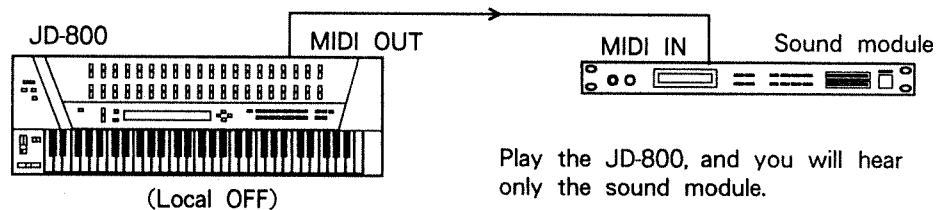

- ① Set the JD-800's Local Control to "off" (☞ P. V - 32).

Playing the JD-800 keyboard will not produce sound.

- ② Set the JD-800's Transmit Channel to match the Receive Channel of the sound module (☞ P. V - 27).
- ③ The following operations will transmit the corresponding MIDI messages to play and control the sound module.

- ◇ Play the keyboard → Note on/off
- ◇ Press the keyboard after playing a note → Aftertouch
- ◇ Move the BENDER/MODULATION lever → Pitch Bend, Modulation
- ◇ Press the Hold pedal → Hold on/off
- ◇ Press the External pedal → Volume / Aftertouch / Modulation / Pan (whichever is selected)
- ◇ Select a Patch → Program Change

○ To play a JD-800 Patch and the external module

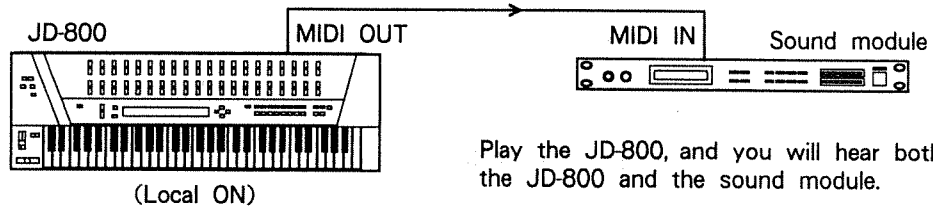

- ① Set the JD-800's Local Control to "on" (☞ P. V - 32).
- ② Set the JD-800 Transmit Channel to match the Receive Channel of the sound module (☞ P. V - 27).
- ③ The following are examples of how this type of setup can be used.

- ◇ Similar sounds such as strings, brass, or organ can be combined (perhaps detuned slightly, or an octave apart) to create rich sounds.
- ◇ An attack-type sound can be combined with a sustain-type sound to create unique sounds (for example, piano and flute).

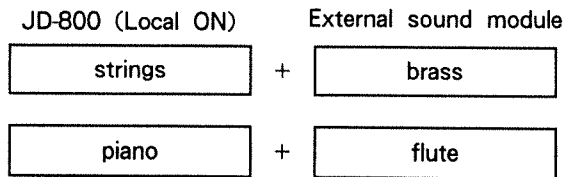

A combination of sounds created this way is sometimes called a "MIDI stack".

By setting the MIDI Tx Ch to "PATCH" and setting an appropriate MIDI Tx PC (☞ II P. I - 136) for each Patch, you can transmit a specific MIDI Program Change message whenever a certain Patch is selected. A MIDI stack can automatically be set up in this way.

● Using the JD-800 with a sequencer

By connecting a sequencer, you can record and playback your musical performances on the JD-800. Refer to the operation manual for your sequencer.

○ Sequencer recording and playback

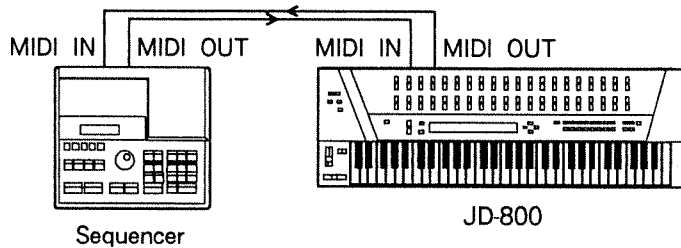

- ① Connect the sequencer and JD-800 as shown in the above diagram.
- ② Set the JD-800's Local Control to "off" (☐ P. V - 32).
- ③ Press the record button on the sequencer, and begin playing.
- ④ Stop recording, and press the playback button to hear the performance you just recorded.

In this setup, the musical data transmitted from the JD-800's MIDI OUT is received at the sequencer's MIDI IN and simultaneously re-transmitted from the sequencer's MIDI OUT. (This function of the sequencer is often called Soft Thru.) The JD-800 then receives these messages and produces sound.

If your sequencer does not have a Soft Thru function, set the JD-800's Local control to "on" (since you will hear no sound if it is turned "off").

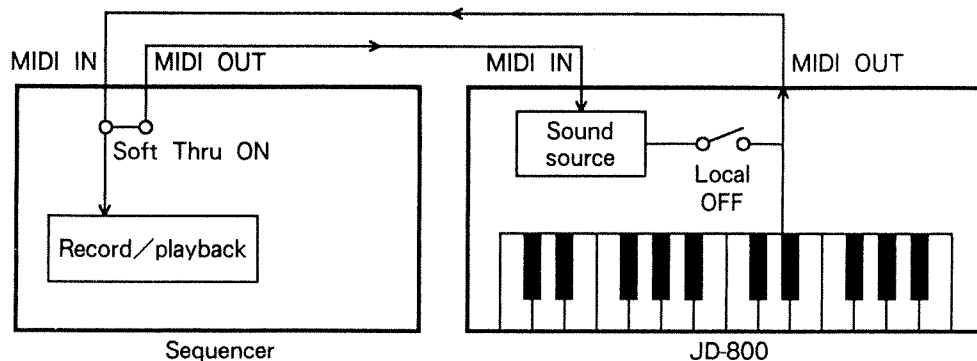

* For details, refer to the operating manual for your sequencer.

b. Using MIDI in Multi mode

In Multi mode, the sound source of the JD-800 functions as five Synth Parts and one Special Part.

The following diagram shows the flow of MIDI messages. The data from the controller section (the keyboard, bender lever, etc.) is transmitted from MIDI OUT (on the MIDI channel specified by the MIDI Tx Ch setting), and is also sent directly to the internal sound source Part selected by **◀PART▶**.

Each Part of the internal sound source will also produce sound in response to incoming messages on its own receive channel.

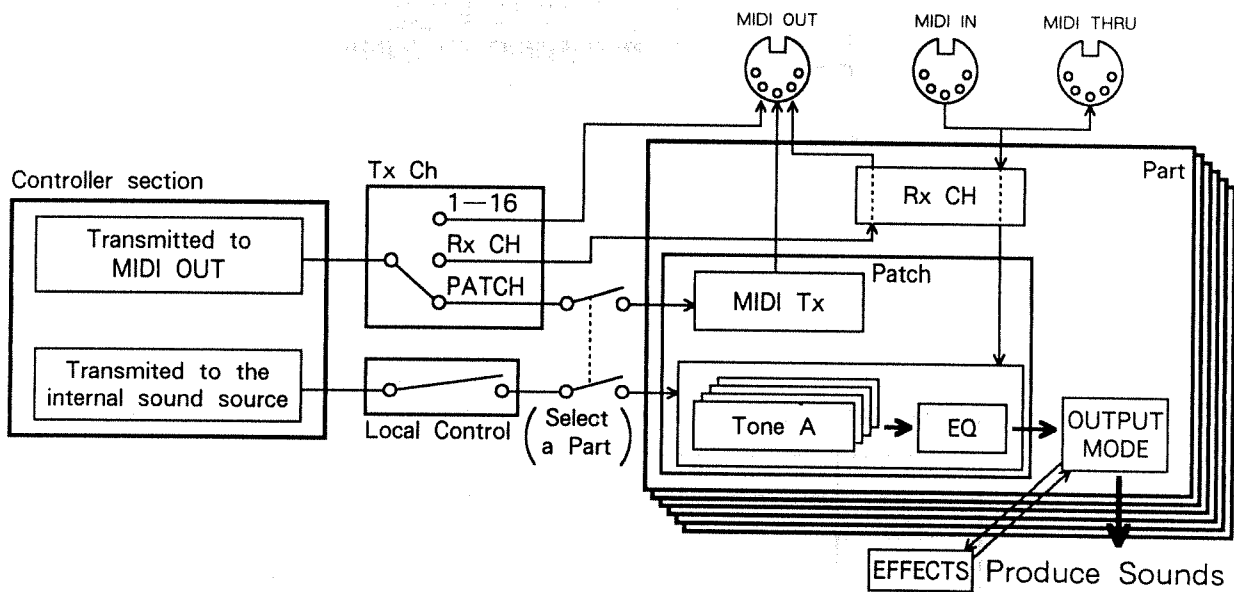

In Multi mode, each Part functions as an independent sound source. In other words, the JD-800 will function as five synthesizers and one rhythm machine connected to a mixer and a multi-effects unit.

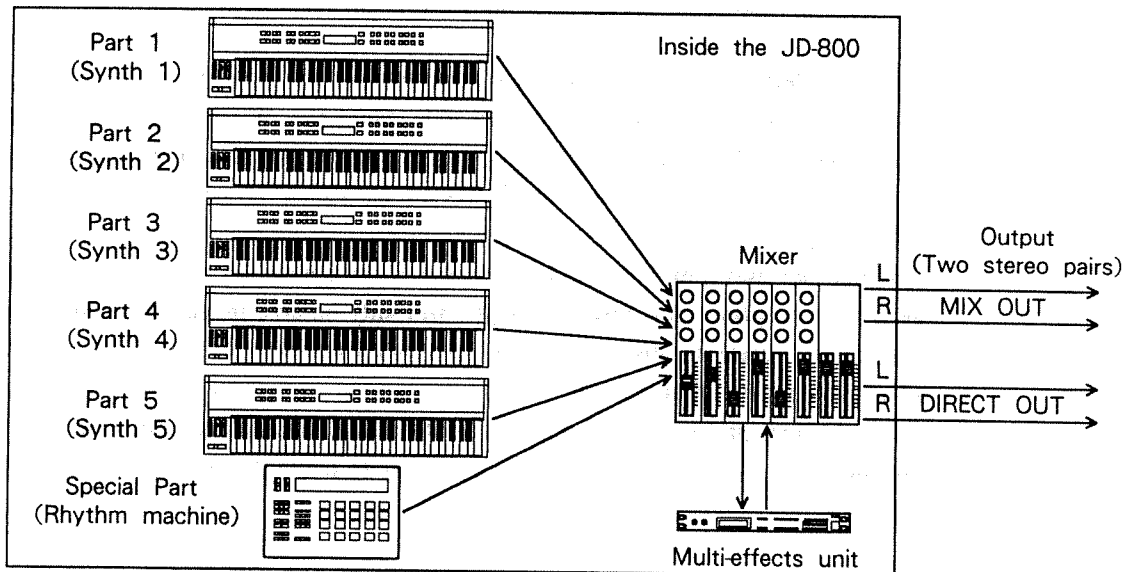

● Using the JD-800 with a sequencer

Multi mode on the JD-800 is most useful when used together with a sequencer. You can set each Part to play a different Patch (such as piano, bass, and guitar), and control all six parts (five Synth parts and the Special Part) independently from the sequencer. The result will be an ensemble performance.

Here we will explain the necessary procedure from connections to recording and playback.

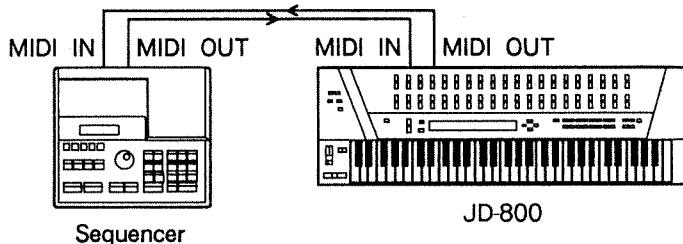

- ① Connect the sequencer and JD-800 as shown in the above diagram.
- ② Set the JD-800's Local Control to "off" (☐ P. V - 32), and set the sequencer's Soft Thrn "ON".
- ③ Set the JD-800 to Multi mode, and select the following Patches for each Part 1—5.

Part	Receive channel	Patch
1	1	I-54 : Modular Bass
2	2	I-23 : LA MIDI Piano 1
3	3	I-36 : Rockin' Wire
4	4	I-75 : Velo - Crunch
5	5	I-52 : Analog Brass
SPECIAL	10	INTERNAL-SETUP

* When selecting Patches for use in a multi-part ensemble, it is a good idea to select Patches that use as few Tones as possible. Since the JD-800 is able to produce a maximum of 24 simultaneous notes (Tones), selecting a Patch that uses many Tones may mean that previously sounding notes will be "stolen" by newly played notes.

A Patch that uses four Tones will consume 4 of these notes for each Note message (for each key you play). This means that you will only be able to play six notes with this Patch; 24 (Tones) divided by 4 (Tones per note) equals 6 (notes). The seventh and subsequent notes will not sound.

To avoid such problems, it is a good idea to select Patches that use as few Tones as possible, and plan your song arrangement so as to make the best use of the available resources.

- ④ First, select the Special Part and play the keyboard to hear. When you have decided on the pattern you want to play on the Special Part, record it into the sequencer.
- ⑤ When you have finished recording the Special Part, select another Part for recording. While playing back the Special Part, record the other Parts. In this example we will record Parts in this order: 1 → 3 → 2 → 5 → 4.
- ⑥ After you have recorded all the Parts, playback the song. As you listen to the song, you may decide that a certain section should be a bit quieter, or that a different Patch should be used for a certain Part. In such cases, you can overdub Program Changes or Volume control messages. You can also edit the effect settings or levels (☞ P. III – 21, III – 22).

MIDI message	Operation
Program Change	press [INT/CARD]BANK[1]–[8]/NUMBER[1]–[8]
Volume	assign the external pedal to VOL (* 1) and move the pedal
Pan	assign the external pedal to PAN (* 1) and move the pedal
Aftertouch	assign the external pedal to AFT (* 1) and move the pedal
Modulation	move the MODULATION lever, or assign the external pedal to MOD (* 1) and move the pedal
Pitch Bend	move the BENDER lever
Hold	press the Hold pedal
Tone data	when Tx edit data is "on" (* 2), move the parameter sliders and switches
Patch data	execute the Patch Dump operation (* 3)

*** 1: Make this setting in Tune/Function (☞ II P. III – 7).**

*** 2: Make this setting in MIDI (☞ P. V – 26).**

*** 3: Execute this operation in Data Transfer Mode (☞ P. V – 23).**

3. TAKING ADVANTAGE OF MIDI

Using MIDI in Multi mode

● Connecting an external sound module

When using the JD-800 in Multi mode to control an external sound module, the important thing is to select the Part appropriately. If possible, the external sound module should also be multi-timbral (U-220, D-110, etc.).

○ To play only the external sound module

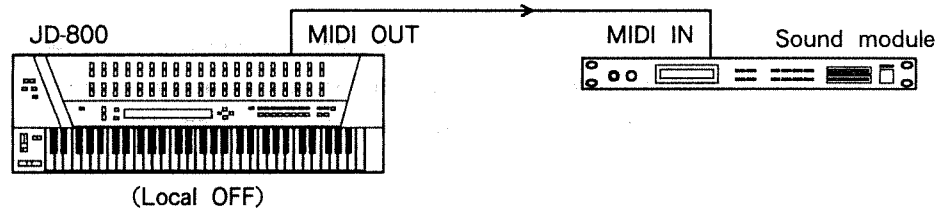

- ① Set the JD-800's Local Control to "off" (☞ P. V - 32).

Playing the JD-800 keyboard will not produce sound.

- ② Set the MIDI channel of each JD-800 Part to match the Receive Channel of each timbre of the sound module (☞ P. V - 29).

- ③ The following operation will transmit the corresponding MIDI message to control the sound module.

- ◇ Play the keyboard → Note on/off
- ◇ Press the keyboard after playing a note → Aftertouch
- ◇ Move the BENDER/MODULATION lever → Pitch Bend, Modulation
- ◇ Press the Hold pedal → Hold on/off
- ◇ Press the External pedal → Volume / Aftertouch / Modulation / Pan (whichever is selected)
- ◇ Select a Patch → Program Change

- ④ By selecting a different JD-800 Part, you can play a different sound on the sound module.

○ To play a JD-800 Patch and the external module

Example: While using the sequencer to play the JD-800 and sound module 1, play the JD-800 keyboard to play the JD-800 and sound module 2.

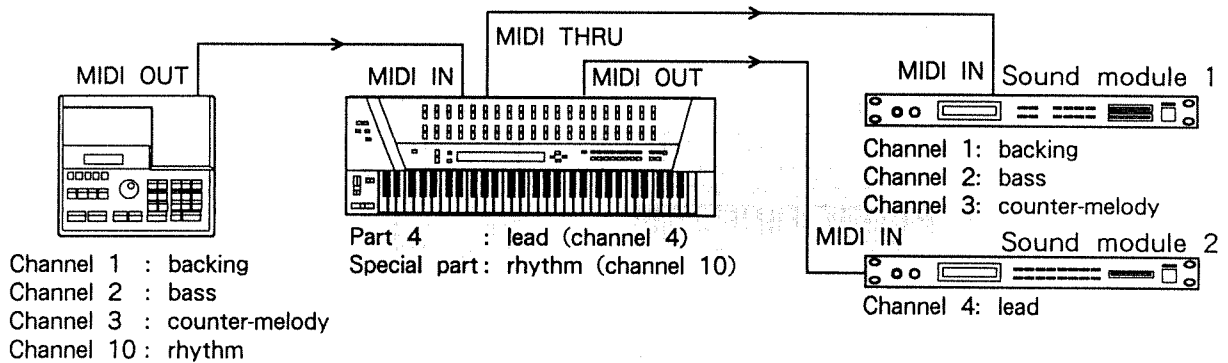

- ① Set the JD-800's Local Control to "on" (☞ P. V - 32).
- ② Make appropriate MIDI channel settings for each part (☞ P. V - 29, V - 31).
- ③ The following are examples of how this type of setup can be used.
 - ◇ Similar sounds such as strings, brass, or organ can be combined (perhaps detuned slightly, or an octave apart) to create rich sounds.
 - ◇ An attack-type sound can be combined with a sustain-type sound to create unique sounds (for example, piano and flute).

You could also have the sequencer play the accompaniment while you play a solo on the JD-800 stacked with the external sound modules.

3. TAKING ADVANTAGE OF MIDI

Exchanging data via Exclusive messages

c. Exchanging data via Exclusive messages

The JD-800 can use Exclusive messages to exchange data with a sequencer or another JD-800. These operations are performed in Data Transfer. Make connections as shown below.

[Connections]

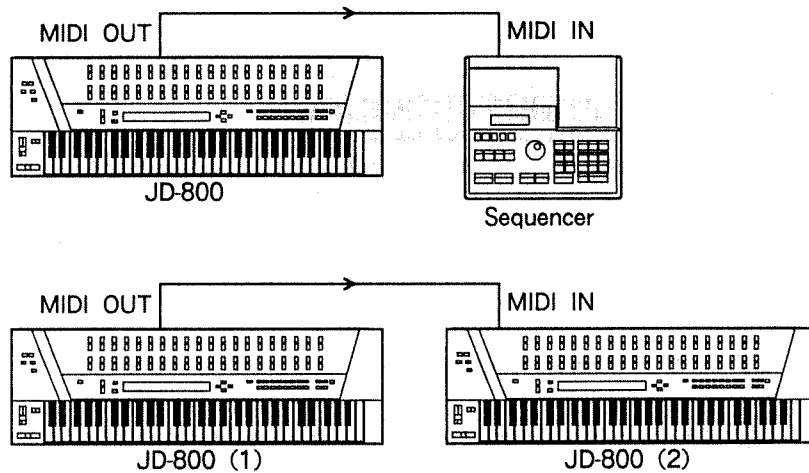

Note when receiving Exclusive messages

Except during ROM Play or Data Transfer, the JD-800 is able to receive Exclusive data any time. However, the MIDI parameter Rx Exclusive (☞ II P. V - 33) must be set to "ON - 1" or "ON - 2". If this is set to "ON - 1", you will also need to set the Unit Number (☞ II P. III - 12) so that the transmitting and receiving devices match.

● Patch Dump

The Patch Dump operation transmits the data of the currently selected Patch.

Transmission procedure

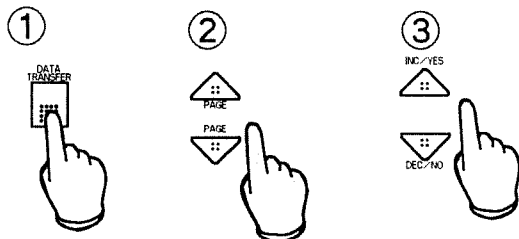

- ① From Play mode, press **DATA TRANSFER**.
- ② Press **PAGE** until the following display appears.

```

DATA TRANS
Patch dump      ? [Y/N]
    
```

- ③ To transmit the data, press **INC/YES**.

The following display will appear, and you will return to Play mode.

```

DATA TRANS
Completed
    
```

If you decide not to transmit, press **DEC/NO** or **EXIT**.

The following display will appear, and you will return to Play mode.

```

DATA TRANS
Canceled
    
```

Patch Dump can be used in a way similar to Program Change messages.

Program Change messages simply specify the number of the Patch to be selected, but a Patch Dump transmits the actual Patch data.

If you edit a Patch while recording into a sequencer, your edits will be lost unless you write them into memory. However, by executing Patch Dump, the edited Patch itself can be recorded and played back.

It is often useful to Patch Dump the Patch data for each Part at the beginning of the song.

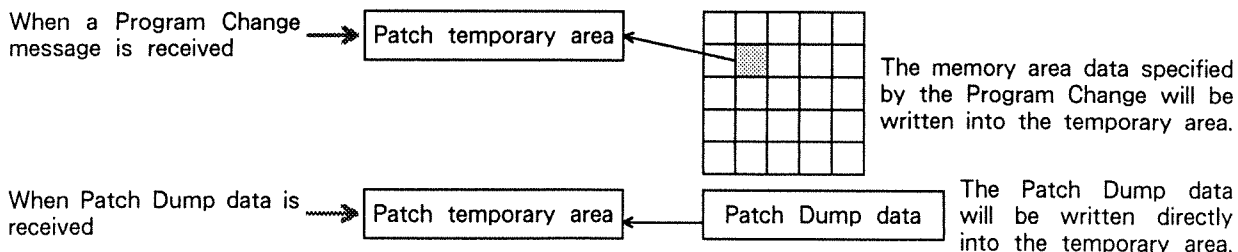

3. TAKING ADVANTAGE OF MIDI

Bulk Dump

● Bulk Dump

The Bulk Dump operation transmits all JD-800 data (all Patches, Setup data, and System data).

○ Transmission procedure

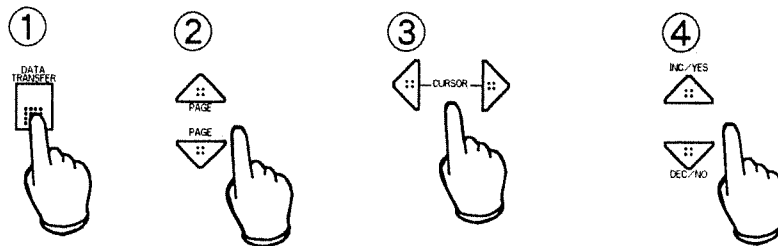

① From Play mode, press **DATA TRANSFER**.

② Press PAGE **▲** **▼** until the following display appears.

```
DATA TRANS INT→MIDI
▶All Patch Setup [Y/N]
```

③ Press CURSOR **◀** **▶** to select the type of data to be transmitted.

```
DATA TRANS INT→MIDI
All▶Patch Setup [Y/N]
```

All —————> System (Effects, Tune/Function), 64 Patches, 1 Special Setup

Patch —————> 64 Patches (I-11—I-88)

Setup —————> Special Setup

-
- ④ To transmit the data, press **YES/INC**.

The following display will appear, and you will return to Play mode.

```
DATA TRANS INT→MIDI
                Completed
```

To quit without transmitting, press **DEC/NO** or **EXIT**, and you will return to play mode.

```
DATA TRANS INT→MIDI
                Canceled
```

The Bulk Dump operation transmits all internal data at once. It is a good idea to use this operation to save JD-800 data in another device. This will provide a complete backup should the original data be accidentally deleted.

3. TAKING ADVANTAGE OF MIDI

Editing data transmission

● Editing data transmission

It is possible to set the JD-800 to transmit the changing data values as you move the front panel sliders and switches.

○ How to transmit data edits

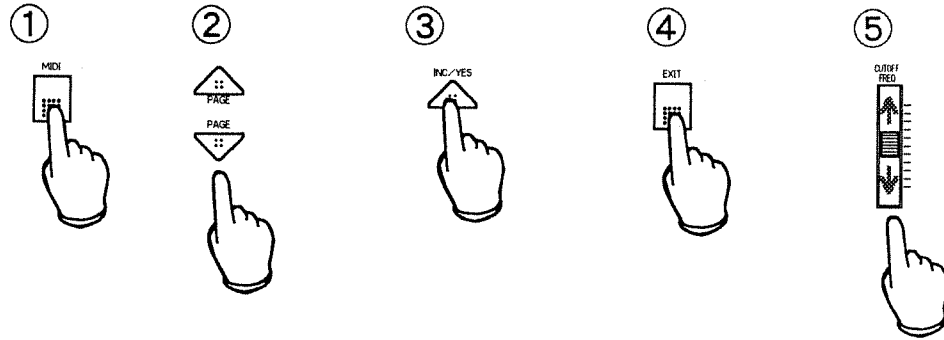

① Press **MIDI**.

② Press the PAGE **▲** **▼** keys to select the following display.

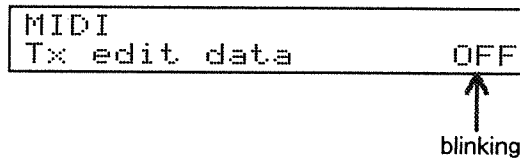

③ Press **INC/YES** to set the value ON.

④ Press **EXIT** to return to the previous play mode.

⑤ When you move a slider or switch to edit a Tone parameter, the data value will be transmitted.

*** If you move many sliders or switches at once, a large amount of exclusive data will be transmitted, which may cause the sound to be delayed or interrupted. For this reason, you should normally leave the “Tx edit data” setting OFF.**

4. MIDI SETTINGS

Make MIDI channel settings

This section will explain the most frequently used MIDI settings. For details of the other settings, refer to the Reference Manual, "MIDI".

● MIDI channel

This is where you make MIDI channel settings. The procedure will depend on whether you are in Single mode or Multi mode.

○ Single mode

◇ Transmit channel setting

Here you can select the transmit channel.

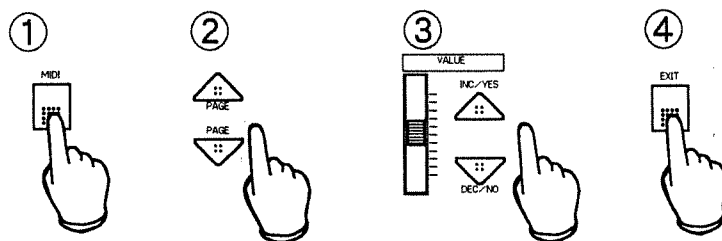

① In Single mode, press **MIDI**.

② Press **PAGE** **▲** **▼** until the following display appears.

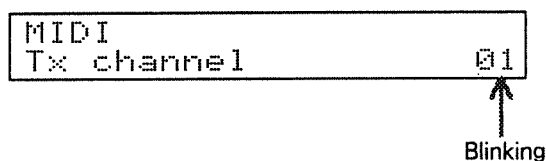

③ Use **INC/YES** and **DEC/NO** or **VALUE** to select channel 1—16, RX CH, PATCH or OFF.

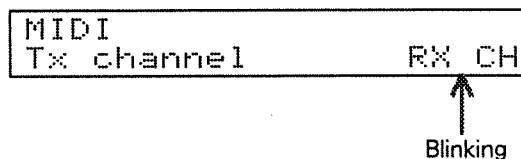

Usually you will set this to "RX CH".

④ Press **EXIT** to return to Play mode.

4. MIDI SETTINGS

Make MIDI channel setting

◇ Receive channel settings

If the transmit channel is set to "RX CH", the receive channel you specify here will also be used as the transmit channel.

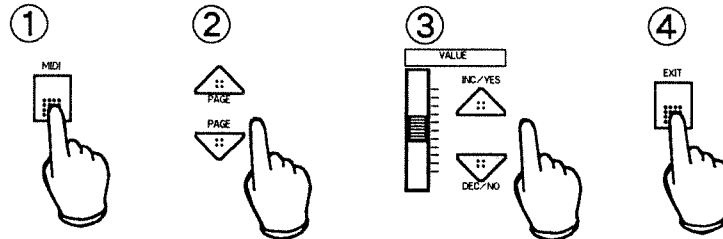

① In Single mode, press **MIDI**.

② Press **PAGE** **▲**/**▼** until the following display appears.

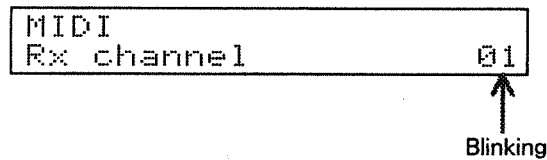

③ Use **INC/YES** and **DEC/NO** or **VALUE** to modify the value. Use **INC/YES** and **DEC/NO** or **VALUE** to select 1—16.

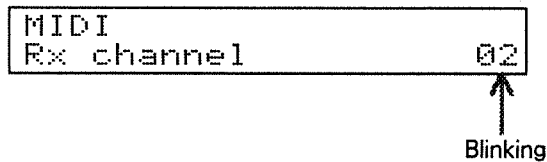

④ Press **EXIT** to return to Play mode.

Make MIDI channel setting

- **Multi mode** In Multi mode, the JD-800 will function as six sound sources (Parts) and one controller section. This means that the transmit channel of the controller section will be set independently from the receive channels of the sound source section (Parts).

◇ **Transmit Channel settings**

Specify the transmit channel.

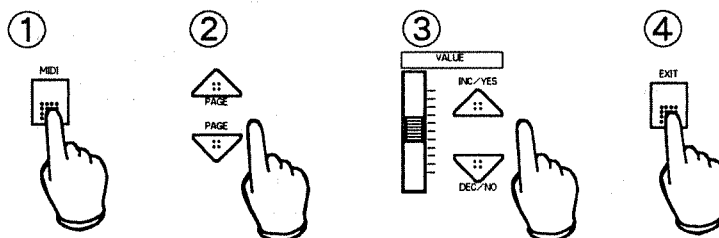

- ① In Multi mode, press **MIDI**.

- ② Press **PAGE** **▲** **▼** until the following display appears.

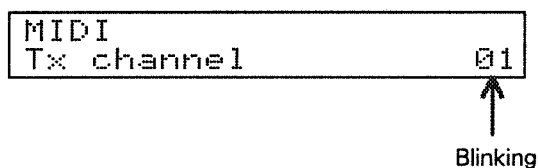

- ③ Use **INC/YES** and **DEC/NO** or **VALUE** to select 1—16, PART, PATCH, or OFF.

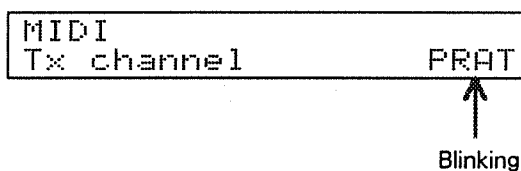

Normally you will set this to "PART".

- ④ Press **EXIT** to return to Play mode.

4. MIDI SETTINGS

Make MIDI channel setting

- If you set this to “PART”, the transmit channel of the control section will automatically match the receive channel of the selected Part. This means that if in Play mode you select a different Part, the transmit channel will automatically change to match the receive channel of the selected Part.

You may think of the control section as being connected to the sound source via MIDI.

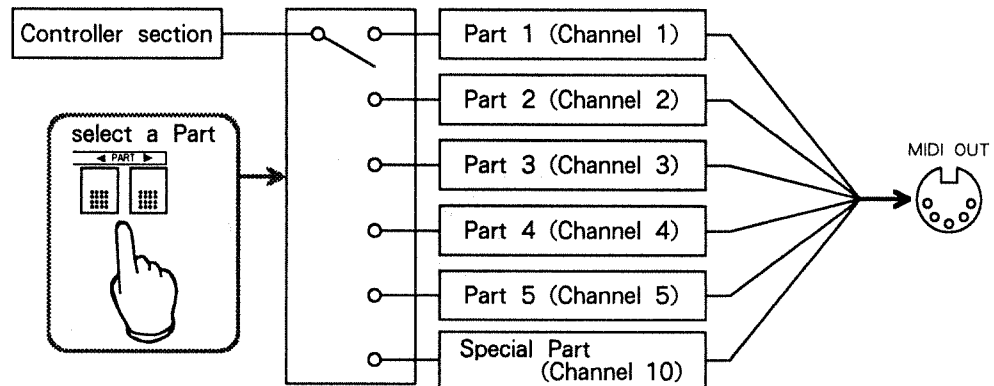

- If you set this to “1”–“16”, the transmit channel of the control section will be fixed. If you select a different part, the transmit channel will not change, but the sound of the Part (the Patch) will change.

In this case, selecting a different Part is the same as selecting a different Patch.

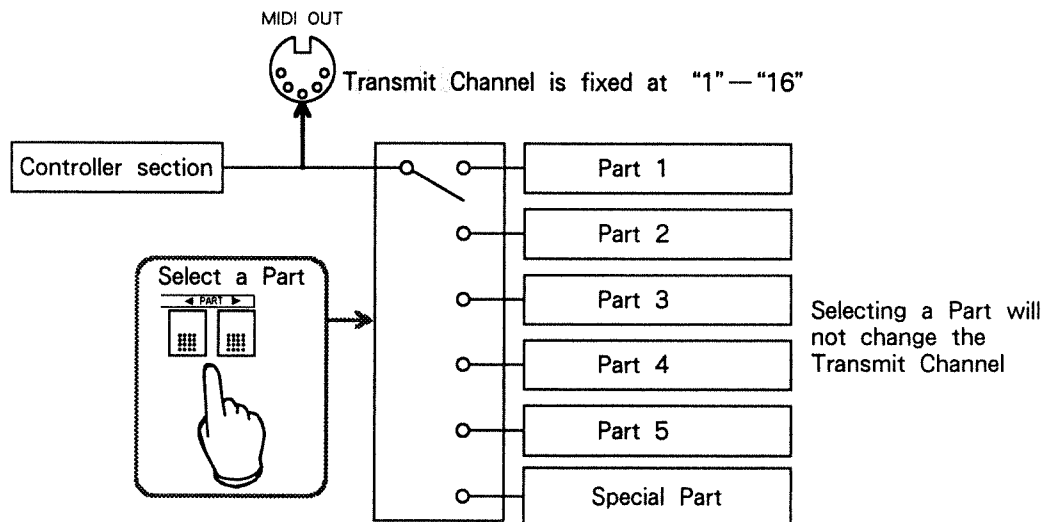

◇ Receive Channel settings

Here you can specify the receive channels of each Part.

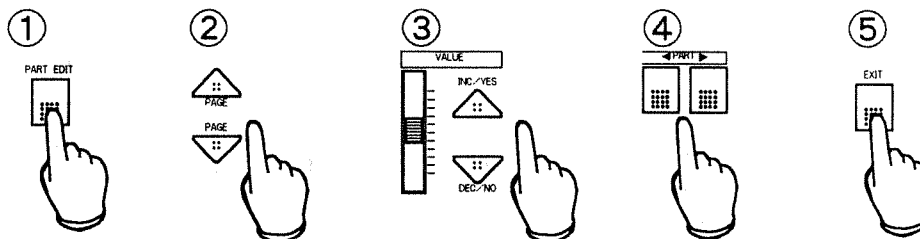

- ① In Multi mode, press **PART EDIT**.
- ② Press **PAGE** until the following display appears.

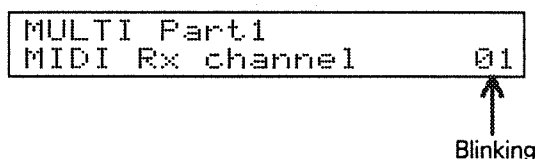

- ③ Use **INC/YES** and **DEC/NO** or **VALUE** to select 1—16 or OFF.

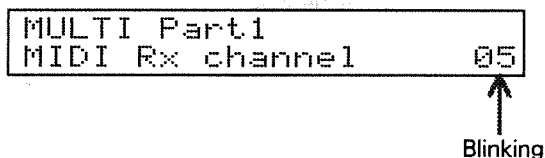

- ④ If you wish to set the receive channel of another Part, press **PART** .
- ⑤ Press **EXIT** to return to Play mode.

Parts that are set to a receive channel “1”—“16” will produce sound in response only to incoming notes of the matching channel. Parts that are set “OFF” will not respond to messages from MIDI IN. By turning unneeded Parts off, you can conserve notes for those Parts which are sounding.

*** Be aware that if the Transmit channel is set to “PART”, MIDI messages will not be transmitted even if you play a Part whose Receive channel is “OFF”.**

Turn Local Control on/off

● Local Control

Here's how to turn Local Control on/off. This setting applies to both Single and Multi mode.

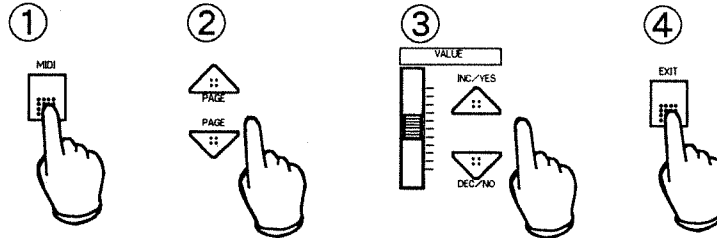

① Press **MIDI**.

② Press PAGE **▲▼** until the following display appears.

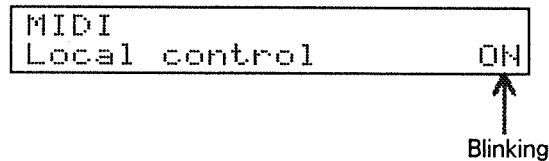

③ Use **INC/YES** and **DEC/NO** or **VALUE** to turn Local Control ON or OFF.

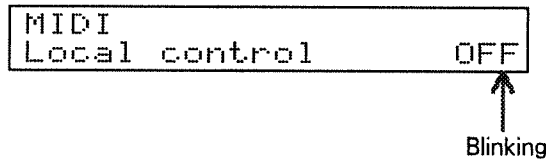

④ Press **EXIT** to return to Play mode.

* If Local Control is "off" and no MIDI devices are connected to the JD-800, there will be no sound at all.

Play two or more Parts as a layer

You can use the following procedure to layer two or more Parts to be played together (Part Layer).

- ① Turn the Local Control "off", and use a MIDI cable to connect the JP-800's MIDI IN to its own MIDI OUT.
- ② Select the same MIDI receive channel for each of the Parts you wish to layer, and set the Transmit channel (☞ P. V - 29) to "PART" or the same channel as the Receive channel.

● Exclusive message reception

This setting determines how Exclusive messages will be received. This setting applies to both Single and Multi mode.

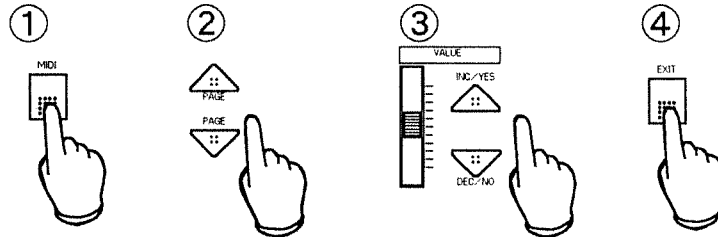

① Press **MIDI**.

② Press PAGE **▲**/**▼** until the following display appears.

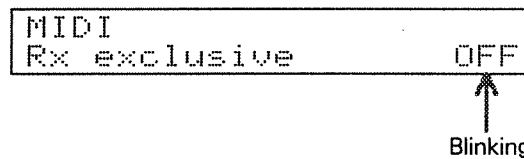

③ Use **INC/YES** and **DEC/NO** or **VALUE** to select OFF, ON - 1, or ON - 2.

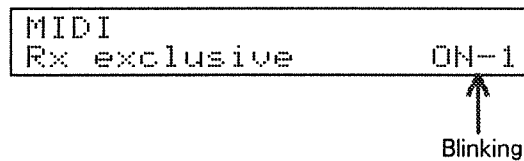

④ Press **EXIT** to return to Play mode.

OFF : Exclusive messages will not be received.

ON - 1 : Only the Exclusive messages of the specified Unit Number (☞ II P. III - 12) will be received. By setting each unit to a different Unit Number, you can control two or more JD-800s from a single sequencer.

ON - 2 : Exclusive messages will be received regardless of the Unit Number.

《When this is set to "ON - 1"》

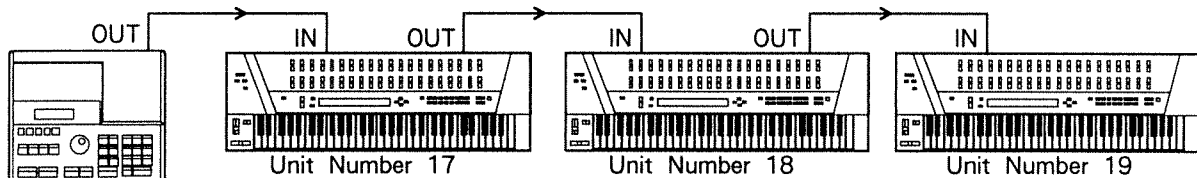

(Exclusive message 1 (Unit Number 17)
Exclusive message 2 (Unit Number 18)
Exclusive message 3 (Unit Number 19)) Exclusive messages of matching Unit Numbers will be received.

If an Exclusive message of Unit Number 19 is transmitted from the sequencer, it will be received by only the last (far right) JD-800.

INDEX

INDEX

INDEX

INDEX

【A】

Active III - 3
Active sensing V - 11
Aftertouch IV - 3
Aftertouch message V - 6
All notes off V - 9

【B】

Bender/Moduration lever IV - 5
Bulk dump V - 24

【C】

Chorus III - 40
Combination of sounds III - 35
Control change message V - 7
Controller section V - 8
Cutoff frequency III - 8

【D】

DATA card IV - 11
Delay III - 40
Detune III - 47
Direct out jack 10
Distortion III - 38

【E】

Edit III - 1
Effect level III - 22
Effect mode III - 22
Effects III - 18
Enhancer III - 39
Envelope III 34
Equalizer III - 17 V , III - 38
Exclusive message V - 11
External control 10

【F】

Filter III - 33

【H】

Headphone jack 10
Hold IV - 6
Hold Pedal jack 10

【I】

Intialize IV - 12

【K】

Key crossfade III - 49
Key range III - 49

【L】

LFO III - 36
LFO 1/2 depth (WG) III - 12
Layer III - 5
Local control V - 8, V - 32

【M】

MIDI V - 2
MIDI Implimentation Chart V - 12
MIDI connectors 10
MIDI messages V - 5
MIDI receive channel (Multi mode) V - 31
MIDI receive channel (Single mode) V - 28
MIDI transmit channel (Multi mode) V - 29
MIDI transmit channel (Single mode) V - 27
Master V - 3
Memory I - 7
Mix Out jacks 10
Mode (TVF) III - 8
Moduration lever sensitivity III - 12
Mono/Poly V - 10
Multi Timbral Sound generator V - 4
Multi mode I - 6, II - 9

【N】

Note message V – 6

【O】

Omni mode V – 9
 One way communication V – 3
 Output assign III – 21

【P】

Palette III – 14
 Pan V – 19
 Part II – 9
 Part edit III – 21
 Part layer V – 32
 Partial III – 33
 Patch III – 3
 Patch dump V – 23
 Patch edit III – 16
 Patch name III – 16
 Phaser III – 38
 Pitch III – 31
 Pitch bend message V – 6
 Pitch envelope III – 34
 Portamento IV – 9
 Program change message V – 7
 Program change number V – 7

【R】

ROM play II – 6
 Realtime edit IV – 10
 Reset All Controllers V – 8
 Resonance III – 9
 Reverb III – 40

【S】

Sequencer V – 3
 Series connection V – 3
 Single mode I – 5, II – 8

Slave V – 3
 Soft Thru V – 16
 Solo Legato III – 37
 Solo IV – 8
 Sound source section V – 8
 Special part II – 11
 Spectrum III – 39
 Stack V – 15
 Star Configuration V – 3

【T】

TVA envelope III – 10, III – 34
 Temporary area I – 7
 Three basic elements of sounds III – 31
 Tone III – 4
 Tone edit III – 5
 Transpose IV – 4
 Tremolo III – 36
 Tuning IV – 2

【V】

Velocity IV – 3
 Velocity message V – 6
 Vibrate III – 36
 Volume message V – 7

【W】

WAVEFORM card III – 7
 Wah wah III – 36
 Waveform III – 6
 Write (Patch) IV – 15
 Write (Special setup) IV – 16

Information

● When you need repair service, call your local Roland Service Station or the authorized Roland distributor in your country as shown below.

U. S. A.

Roland Corp US
7200 Dominion Circle
Los Angeles, CA. 90040 - 3647
U. S. A.
☎ (213)685 - 5141

CANADA

Roland Canada Music Ltd.
(Head Office)
13880 Mayfield Place
Richmond B. C., V6V 2E4
CANADA
☎ (604)270 - 6626

Roland Canada Music Ltd.
9425 Transcanadienne
Service Rd. N.,
St Laurent, Quebec H4S 1V3
CANADA
☎ (514)335 - 2009

Roland Canada Music Ltd.
346 Watline Avenue,
Mississauga, Ontario L4Z 1X2
CANADA
☎ (416)890 - 6488

AUSTRALIA

Roland Corporation
(Australia) Pty. Ltd.
(Head Office)
38 Campbell Avenue
Dee Why West. NSW 2099
AUSTRALIA
☎ (02)982 - 8266

Roland Corporation
(Australia) Pty. Ltd.
(Melbourne Office)
50 Garden Street
South Yarra, Victoria 3141
AUSTRALIA
☎ (03)241 - 1254

NEW ZEALAND

Roland Corporation (NZ) Ltd.
97 Mt. Eden Road, Mt. Eden,
Auckland 3
NEW ZEALAND
☎ (09)398 - 715

UNITED KINGDOM

Roland(UK)Ltd.
Amalgamated Drive
West Cross Centre, Brentford,
Middlesex TW8 9EZ,
UNITED KINGDOM
☎ (81)568 - 4578

GERMANY

Roland Elektronische
Musikinstrumente
Handelsgesellschaft mbH.
Oststrasse 96,
2000 Norderstedt
GERMANY
☎ 040/52 60 090

BELGIUM/HOLLAND/ LUXEMBOURG

Roland Benelux N. V.
Houtstraat 1
B - 2431 Oevel - Westerlo
BELGIUM
☎ (0032)14 - 575811

DENMARK

Roland Scandinavia as
Langebrogade 6
Box 1937
DK - 1023 Copenhagen K.
DENMARK
☎ 31 - 95 31 11

SWEDEN

Roland Scandinavia as
DanvikCenter 28 A, 2 tr.
S - 131 30 Nacka,
SWEDEN
☎ 08 - 702 00 20

NORWAY

Roland Scandinavia
Avd. Norge
Lilleakerveien 2
Postboks 95 Lilleaker
N - 0216 Oslo 2
NORWAY
☎ 02 - 73 00 74

FINLAND

Fazer Musik Inc.
Länsituulentie
POB 169
SF - 02101 Espoo
FINLAND
☎ 0 - 43 50 11

ITALY

Roland Italy S. p. A.
Viale delle Industrie 8
20020 ARESE MILANO
ITALY
☎ 02 - 93581311

SPAIN

Roland Electronics
de España, S. A.
Bolivia 239
08020 Barcelona
SPAIN
☎ 93 - 308 - 1000

SWITZERLAND

Musitronic AG
Gerberstrasse 5, CH - 4410
Liestal
SWITZERLAND
☎ 061/921 16 15

Roland CK (Switzerland) AG
Hauptstrasse 21/Postfach
CH - 4456 Tenniken
SWITZERLAND
☎ 061/98 60 55
Repair Service by Musitronic AG

FRANCE

Musikengro
102 Avenue Jean - Jaures
69007 Lyon Cedex 07
FRANCE
☎ (7)858 - 54 60

Musikengro
(Paris Office)
Centre Region Parisienne
41 rue Charles - Fourier,
94400 Vitry s/Seine
FRANCE
☎ (1)4680 86 62

AUSTRIA

E. Dematte & Co.
Neu - Rum Siemens - Strasse 4
A - 6021 Innsbruck Box 591
AUSTRIA
☎ (0512)63 451

GREECE

V. Dimitriadis & Co. Ltd.
2 Phidiou Str., GR 106 78
Athens
GREECE
☎ 1 - 3620130

PORTUGAL

Casa Caius Instrumentos
Musicais Lda.
Rua de Santa Catarina 131
Porto
PORTUGAL
☎ 02 - 38 44 56

HUNGARY

Intermusica Ltd.
Warehouse Area 'DEPO'
Budapest. P.O. Box 3,
2045 Torokbalint
HUNGARY
☎ (1)1868905

BRAZIL

Foresight Corporation
Rua Coronel Octaviano
da Silveira
136 05522 Sao Paulo, SP
BRAZIL
☎ (011)843 - 9377

For Nordic Countries

Apparatus containing Lithium batteries

ADVARSEL !

Lithiumbatteri. Eksplosionsfare.
Udskiftning må kun foretages af en sagkyndig,
og som beskrevet i servicemanual.

VARNING !

Lithiumbatteri. Explosionsrisk.
Får endast bytas av behörig servicetekniker.
Se instruktioner i servicemanualen.

ADVARSEL !

Lithiumbatteri. Fare for eksplosion.
Må bare skiftes av kvalifisert tekniker som
beskrevet i servicemanualen.

VAROITUS !

Lithiumparisto. Rajähdyysvaara.
Pariston saa vaihtaa ainoastaan
alan ammottimies.

For Germany

Bescheinigung des Herstellers/Importeurs

Hiermit wird bescheinigt, daß der/die/das

in Übereinstimmung mit den Bestimmungen der

PROGRAMMABLE SYNTHESIZER JD-800

Amtsbl. Vfg 1046/1984

(Gerät. Typ. Bezeichnung)

(Amtsblattverfügung)

funk-entstört ist.

Der Deutschen Bundespost wurde das Inverkehrbringen dieses Gerätes angezeigt und die Berechtigung zur Überprüfung der Serie auf Einhaltung der Bestimmungen eingeräumt.

Roland Corporation Osaka/Japan

Name des Herstellers/Importeurs

For the USA

RADIO AND TELEVISION INTERFERENCE

WARNING — This equipment has been verified to comply with the limits for a Class B computing device, pursuant to Subpart J, of Part 15, of FCC rules. Operation with non-certified or non-verified equipment is likely to result in interference to radio and TV reception.

The equipment described in this manual generates and uses radio frequency energy. If it is not installed and used properly, that is, in strict accordance with our instructions, it may cause interference with radio and television reception. This equipment has been tested and found to comply with the limits for a Class B computing device in accordance with the specifications in Subpart J, of Part 15, of FCC Rules. These rules are designed to provide reasonable protection against such an interference in a residential installation. However, there is no guarantee that the interference will not occur in a particular installation. If this equipment does cause interference to radio or television reception, which can be determined by turning the equipment on and off, the user is encouraged to try to correct the interference by the following measure:

- Disconnect other devices and their input/output cables one at a time. If the interference stops, it is caused by either the other device or its I/O cable. These devices usually require Roland designated shielded I/O cables. For Roland devices, you can obtain the proper shielded cable from your dealer. For non Roland devices, contact the manufacturer or dealer for assistance.
- If your equipment does cause interference to radio or television reception, you can try to correct the interference by using one or more of the following measures:
 - Turn the TV or radio antenna until the interference stops.
 - Move the equipment to one side or the other of the TV or radio.
 - Move the equipment farther away from the TV or radio.
 - Plug the equipment into an outlet that is on a different circuit than the TV or radio. (That is, make certain the equipment and the radio or television set are on circuits controlled by different circuit breakers or fuses.)
 - Consider installing a rooftop television antenna with coaxial cable lead-in between the antenna and TV. If necessary, you should consult your dealer or an experienced radio/television technician for additional suggestions. You may find helpful the following booklet prepared by the Federal Communications Commission: "How to Identify and Resolve Radio — TV Interference Problems"

This booklet is available from the U.S. Government Printing Office, Washington, D.C. 20402, Stock No. 004-000-00345-4

For Canada

CLASS B

NOTICE

This digital apparatus does not exceed the Class B limits for radio noise emissions set out in the Radio Interference Regulations of the Canadian Department of Communications.

CLASSE B

AVIS

Cet appareil numérique ne dépasse pas les limites de la classe B au niveau des émissions de bruits radioélectriques fixés dans le Règlement des signaux parasites par le ministère canadien des Communications.

