

 Roland®



Owner's Manual Set

Vol 1 & Vol 2

CONTENTS

Volume 1

The Roland D-20 is a multi timbral, linear synthesizer with a built-in multi track sequencer.

Please read the owner's manual thoroughly to make the best use of the Roland D-20.

1	Panel Description	5
2	Outline of the D-20	9
1.	Features of the D-20	9
2.	Modes	11
3.	Partials and the maximum voices	14
3	Connections	15
4	Performance Mode	16
1.	Power-up	16
2.	Patch Selection	17
3.	Performance Controlling Functions	22
a.	Bender Lever	22
b.	Velocity	22
c.	Hold	22
4.	Rhythm Play	23
a.	Track Play	23
b.	Rhythm Mode	25
5.	Metronome	28
6.	Master Tuning	31
7.	Key Transpose	32
5	ROM Play Mode	33
6	Specifications	35

For Canada

CLASS B

NOTICE

This digital apparatus does not exceed the Class B limits for radio noise emissions set out in the Radio Interference Regulations of the Canadian Department of Communications.

CLASSE B

AVIS

Cet appareil numérique ne dépasse pas les limites de la classe B au niveau des émissions de bruits radioélectriques fixés dans le Règlement des signaux parasites par le ministère canadien des Communications.

IMPORTANT NOTES

POWER

The appropriate power supply for this unit is shown on its name plate. Please make sure that the line voltage in your country meets the requirement.

Do not use the same socket used for any noise generating device (such as a motor or variable lighting system) or large power consuming device.

When connecting the power cable to the socket, be sure that the unit is turned off.

When disconnecting the power plug from the socket, do not pull the cord but hold the plug to avoid damaging the cord.

Handle the power cord gently.

If the unit is not to be used for a long period of time, unplug the power cord from the socket.

It is normal for this unit to become hot during operation.

Before setting up this unit with other devices, turn this unit and all the other units off.

This unit might not work properly if turned on immediately after being turned off. If this happens, simply turn it off and turn it on again after waiting a few seconds.

CLEANING

Use a mild detergent for cleaning. Do not use solvents such as thinner.

LOCATION

Do not place this unit in the following conditions:

In extreme heat (where it may be affected by direct sunlight, near a heater, etc) In extreme humidity Where it may be affected by dust or vibration

Operating this device near a neon, fluorescent lamp, TV or CRT display may cause noise interference. If so, change the angle or the position of the device.

If you operate this unit near a TV or radio which is turned on, noise or picture trouble may occur. If this happens, move the unit away from it.

Do not place anything heavy on this unit or the power cord.

Strong magnetic field such as a speaker may disturb proper function of the disk.

Place this unit in a steady, horizontal place. If it is inclined upward at more than 20 degrees or downward at more than 20 degrees, the disk drive may not function properly.

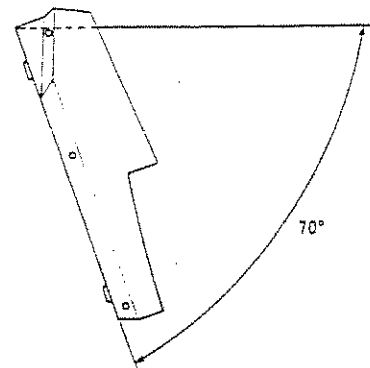
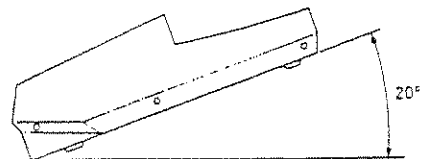

MEMORY BACK-UP

This device features a memory back-up system that retains the data even when switched off. The battery that supports the back-up circuit should be replaced every five years. Call Roland for battery replacement. (The first replacement may be required before five years, depending on how much time had passed before you purchased the device.)

To avoid accidental erasure or loss of data, please make a data memo or save the data onto a memory card. If it happens to be erased while the device is being repaired, there is no way to restore the data.

When the battery is low, the Display defaults as shown below, and the data in memory may be lost.

HOW TO HANDLE A FLOPPY DISK

The built-in disk drive is a precise machine. Place the unit in a steady, horizontal place to avoid shock or vibration. Specially when the disk drive is running, do not give shock or vibration to the unit.

Floppy disks are delicate and can be ruined if not handled properly. Do not touch the shutter that covers the magnetic film. The magnetic film can be easily damaged even by slight amount of grease.

Make a few copies of important data.

Do not switch on or off the unit with a disk connected in the disk drive.

Insert a disk securely into the disk drive until it clicks. When removing the disk, push the Eject Button firmly. If the disk has stuck in the disk drive, simply push the Eject Button.

Never remove the disk, or switch the unit off, while the disk is running (when the disk drive indicator is lit). The disk may be permanently damaged. And while the disk drive is running, do not give strong shock to this unit, or data may be improperly read from the disk.

Keep the disk away from extremely hot or cold temperatures, direct sunlight or dust.

To prevent accidental loss of data, be sure to set the Protect Tab to the PROTECT position.

Attach the label firmly to the disk. If it comes off in the disk drive, the disk will be stuck.

Do not expose the disk to strong magnetick field such as speakers.

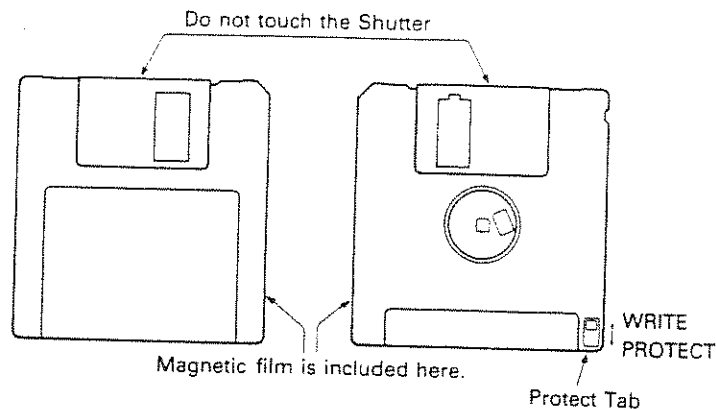

* To prevent accidental loss of data, be sure to set the Protect Tab to the PROTECT position except when writing (recording) data.

] PANEL DESCRIPTION

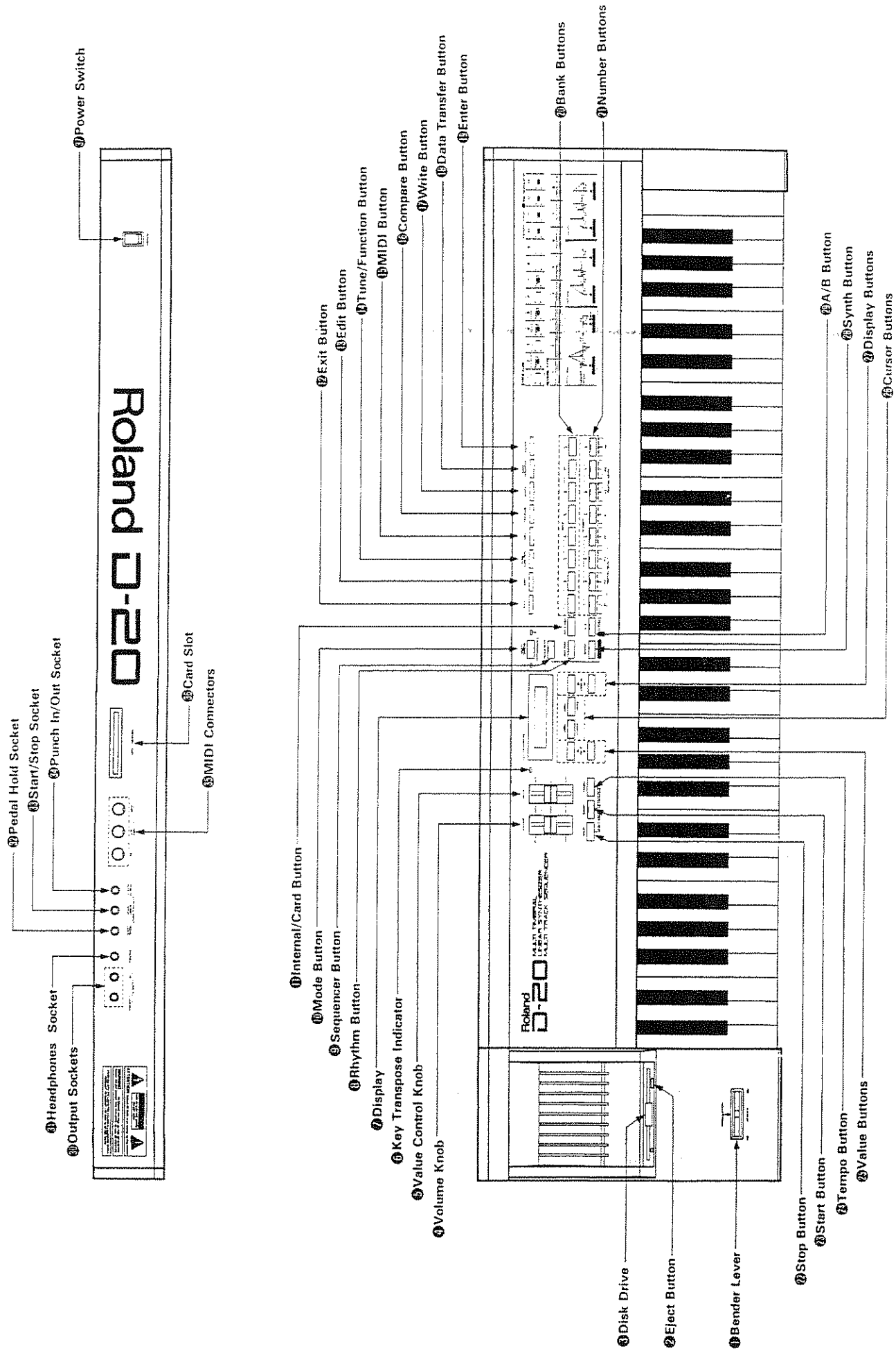

- ① Bender Lever**
Using the Bender Lever, you can change the pitch, or create a vibrato effects.
- ② Eject Button**
Push this button to remove a disk from the disk drive.
- ③ Disk Drive**
This is where a floppy disk is inserted.
- ④ Volume Knob**
This controls the volume of the sound sent from the Output Socket and Headphones Socket.
- ⑤ Value knob**
Use this knob to change values. During playback, this is used for tempo control.
- ⑥ Key Transpose Indicator**
This is lit while the Key Transpose function is turned on.
- ⑦ Display Window**
This shows the current condition of the D-20.
- ⑧ Rhythm Button**
Push this button to switch the D-20 to rhythm machine mode. When the indicator of the button is lit, the D-10 works as a rhythm machine and the rhythm patterns can be changed by using the Bank and Number Buttons.
- ⑨ Sequencer Button**
Pushing this button turns the D-20 to a MIDI sequencer (=the indicator of the button is lit). A Track to be played can be selected with the A/B or NUMBER buttons.
- ⑩ Mode Button**
This button selects the Performance or Multi Timbral mode. The indicator (on either side of the button) of the corresponding mode will light up.
- ⑪ Internal/Card Button**
This selects the internal memory or memory card where the sound to be used is stored.
- ⑫ Exit Button**
Use this button to return to the Play mode from another mode.
- ⑬ Edit Button**
Push this button to enter the Edit mode.
- ⑭ Tune/Function Button**
Push this button for changing the values of parameters related to tuning, such as the Master Tuning.
- ⑮ MIDI Button**
Push this button for editing MIDI functions.
- ⑯ Compare Button**
Using this button, you can call the original Tone, to compare it with your edited version.
- ⑰ Write Button**
Push this button to begin the writing process.
- ⑱ Data Transfer Button**
Push this button to perform Data Transfer functions.
- ⑲ Enter Button**
Push this button to execute a specific procedure.
- ⑳ Bank Buttons**
In the Play mode, these buttons are used for changing sounds, but they function differently in other modes.
- ㉑ Number Buttons**
In the Play mode, these buttons are used for changing sounds, but they function differently in other modes.
- ㉒ Stop Button**
Push this button to stop playing a Rhythm or song.

② Start Button

Push this button to start playing a Rhythm or song.

③ Tempo Button

Push this button to see the tempo value currently set, or to change metronome values.

④ Value Buttons

These buttons can be used for fine value control. Pushing the ▲ button increases the value and the ▼ button decreases it. During data playback this can be used for tempo control.

⑤ Cursor Buttons

Use these buttons for moving a cursor or selecting a parameter in the Display.

⑥ Display Buttons

These buttons are used for changing displays. Pushing the ▲ button advances the display, and the ▼ button goes back to the previous display.

⑦ Synth Button

Push this button to return to the Play mode from the Rhythm or Sequencer mode. When the indicator of this button is lit, you can change Patches (Timbres) with the Bank and Number Buttons.

⑧ A/B Button

This selects a Group, A or B, of a Patch (Timbre).

⑨ Output Sockets

These output sockets operate in stereo output during rhythm play or in the Multi Timbral mode.

⑩ Headphones Socket

Connect stereo headphones to this socket. (The best possible headphones to be used should have an impedance from 8 to 150 ohms.) Even when headphones are connected to this socket, the Output Sockets still send signals.

⑪ Pedal Hold Socket

By connecting the optional pedal switch (DP-2, DP-6), the Hold effect can be controlled with the pedal.

⑫ Start/Stop Socket

By connecting the optional pedal switch (DP-2, DP-6), the Rhythm can be controlled with the pedal.

⑬ Punch In/Out Socket

By connecting optional pedal switches (DP-2 or DP-6) to these sockets, the Punch In/Out function can be obtained during recording.

⑭ MIDI Connectors

These are used to connect other MIDI devices.

⑮ Card Slot

Insert a memory card here.

⑯ Power Switch

This turns the unit on or off.

2 OUTLINE OF THE D-20

The Roland D-20 is a multi timbral, linear synthesizer with a built-in sequencer, designed for both keyboardists and multi-track recording.

The following will explain the features and the modes of the D-20.

1. Features of the D-20

● LA Sound Source

The D-20's LA sound source allows warm analog type sounds as well as sharp attack digital-type sounds.

● Performance Mode and Multi Timbral Mode

The Performance mode may be selected for playing the D-20 using its own keyboard, and the Multi Timbral mode is suitable for ensemble performance using a built-in sequencer.

● Tone

The D-20's internal memory stores 128 different preset Tones, 64 programmable Tones and 63 preset Rhythm Tones.

● Patch and Timbre

A sound consists of a Tone or a pair of Tones and performance controlling functions. In the Performance Mode, two Tones are assigned to a sound (=Patch), and in the Multi Timbral Mode, only one Tone is assigned to a sound (=Timbre).

● Reverb

The digital reverbration section of the D-20 can create reverb effects. In the Performance mode, a different reverb effect can be set for each Patch.

● Multi Track Sequencer

The built-in sequencer is a multi track sequencer with 9 tracks including the Rhythm Track. Using the sequencer in the Multi Timbral mode, you can enjoy ensemble.

● Rhythm Tone

When using the D-20 as a rhythm machine, you can use Tones you have programmed as well as the 63 Preset Rhythm Tones (altogether 85 tones). Also, it is possible to set the Pan and Level parameters for each Rhythm Tone, and therefore obtain the desired volume balance in the stereo outputs.

● Rhythm Machine

The built-in rhythm machine stores 32 different preset rhythm patterns and another 32 user programmable patterns. You can make a song (or tune) in a rhythm track by using those rhythm patterns. You can record the real-time rhythm performance in other tracks for making variations.

● Metronome

The metronome can be used not only for practicing the keyboard but for making a rhythm pattern or sequencer recording.

● Floppy Disk

Using a floppy disk, you can save your original sound data and recorded performance for future use.

● Memory Card

Using an optional memory card (M-256D, M-256E), your original sound data and rhythm data can be saved for future use.

2. Modes

The D-20 features various modes which should be selected depending on what you wish to achieve.

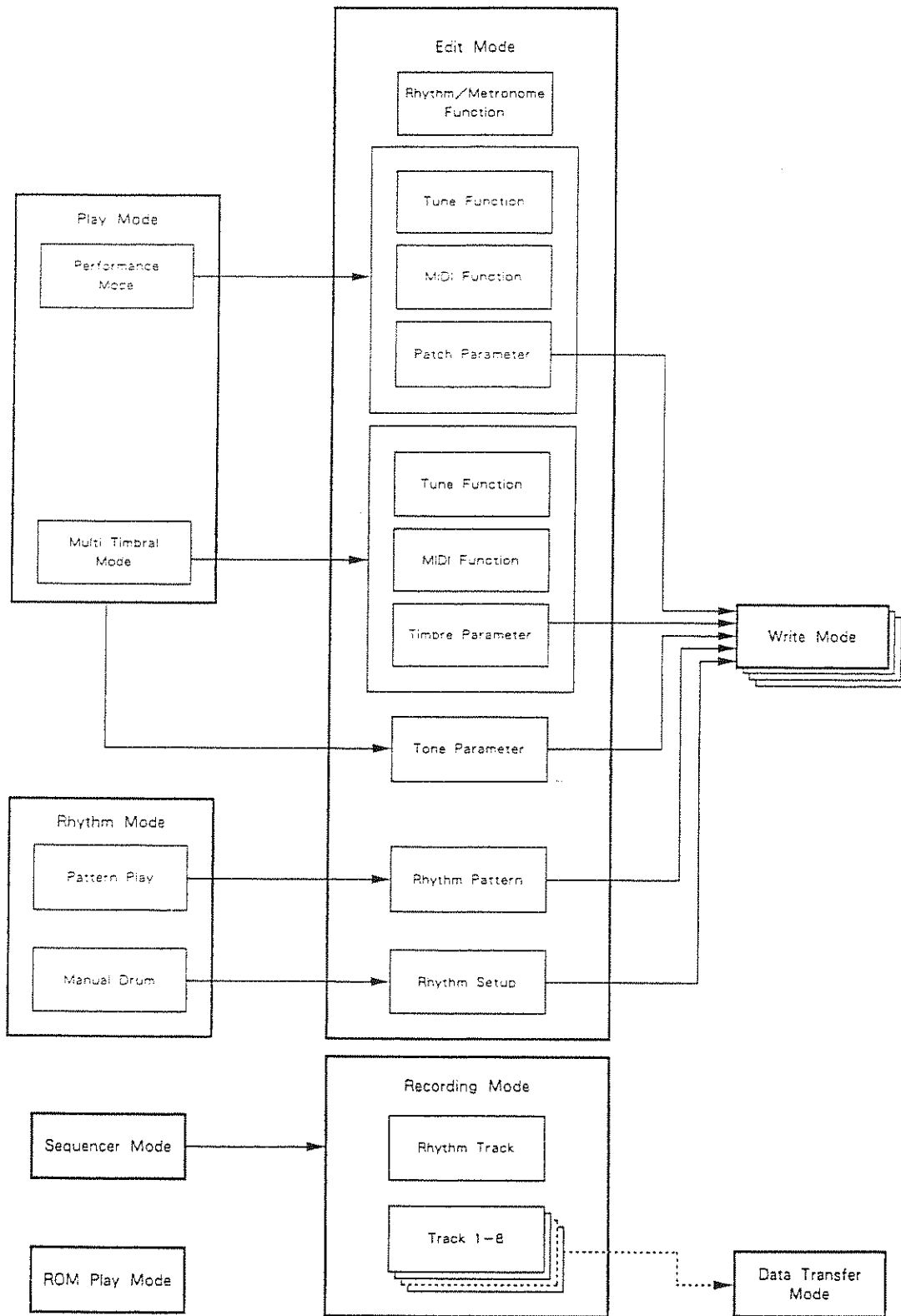

[Play Mode]

There are two different Play modes, Performance and Multi Timbral modes, and each mode allows you to select the Patch or Timbre you prefer.

● Performance Mode

The Performance mode may be selected for playing the D-20 using its own keyboard. You can play the keyboard to the rhythm played in the Rhythm section.

● Multi Timbral Mode

In the Multi Timbral mode, the D-20 works as a rhythm and 8 independent synthesizers. You can play an ensemble style performance using the built-in Multi Track sequencer.

[Rhythm Mode]

This mode turns the D-20 into a rhythm machine. You can select a rhythm pattern or play the keyboard using the Rhythm Tones.

[Edit Mode]

This mode allows you to edit various parameters. Normally, the edited version does not rewrite the previous data unless the appropriate writing procedure is taken.

[Recording Mode]

The Recording mode allows you to record performance data into the sequencer section. Recorded data will be erased when the unit is turned off except when it is recorded in the Rhythm Track, therefore, if you wish to retain the data, save it onto a floppy disk by taking "Data Transfer" procedure.

[Write Mode]

The Write mode allows you to write an edited version into the internal memory of the D-20 or onto a memory card.

[Data Transfer Mode]

The Data Transfer mode allows you to copy the entire data written in the D-20's internal memory onto a memory card, a floppy disk, or into the internal memory of another D-20, and also copy the data on the memory card, on the floppy disk or in the D-20 into another D-20.

[ROM Play Mode]

In this mode, you can play any of the 8 songs which are preprogrammed in the D-20 to demonstrate the effects of the Multi Timbral function.

3. Partial and Maximum Voices

The D-20 can produce a maximum of 32 voices using 32 Partials at the same time. A Partial is the smallest unit of sound within the D-20. A Tone consists of one to four Partials. A Tone made of only one Partial can be played 32 voice polyphonically, but a Tone of two Partials has 16 voices, and a Tone of four Partials is 8 voice polyphonic. It is very important that you fully understand this concept. Specially in the Multi Timbral mode, this can be very tricky as several Tones are involved at the same time.

3 CONNECTIONS

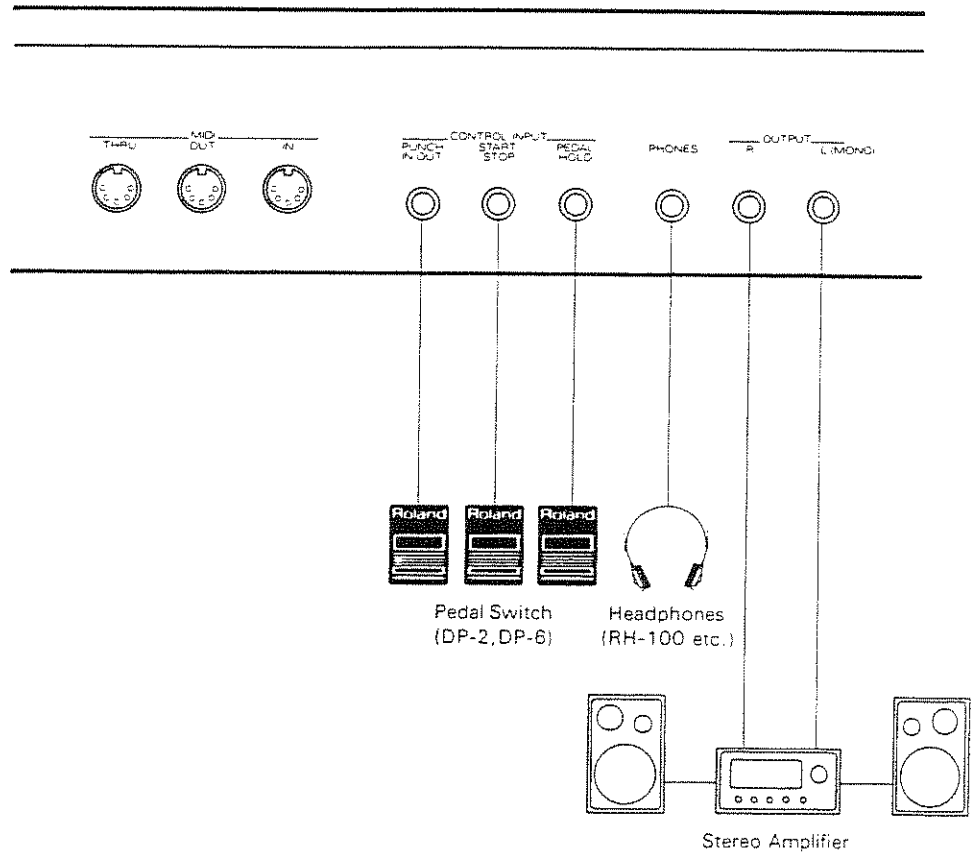

4 PERFORMANCE MODE

This section explains how to operate the D-20 in the Performance mode.

1. Power-up

Make sure that the D-20 is securely and correctly connected to the external devices, then turn the D-20 on.

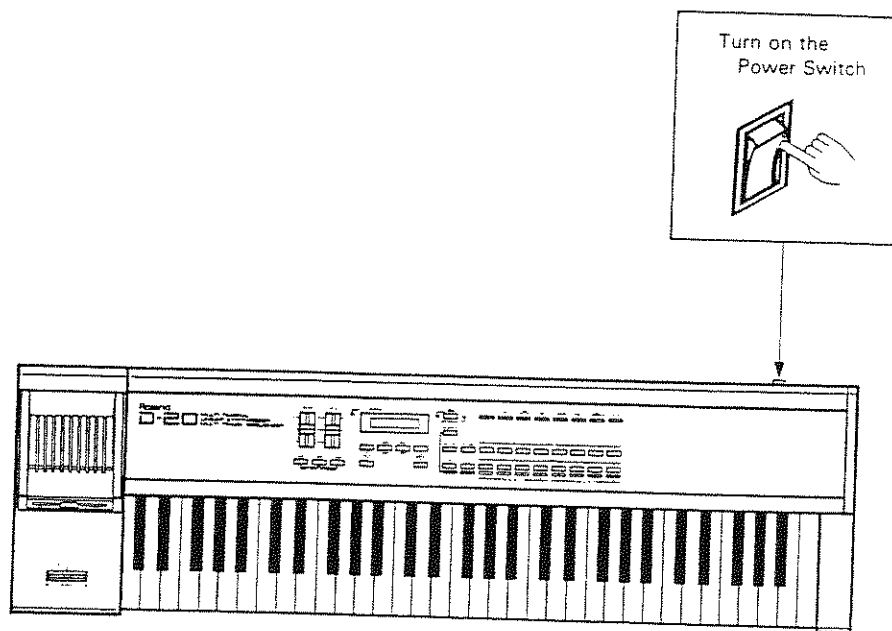

The Display will change as shown below.

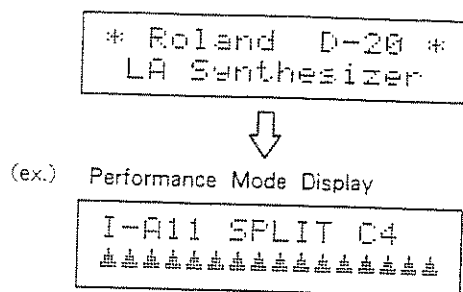

If the Display does not respond as above, press the Mode Button to switch to the Performance mode.

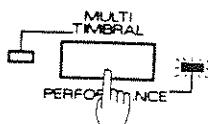

2. Patch Selection

A Patch is represented by a Group (A or B), Bank (1 to 8) and Number (1 to 8). The internal memory of the D-20 can store up to 128 Patches and a memory card can also store 128 Patches, allowing you to select from 256 Patches, just by pressing the relevant buttons.

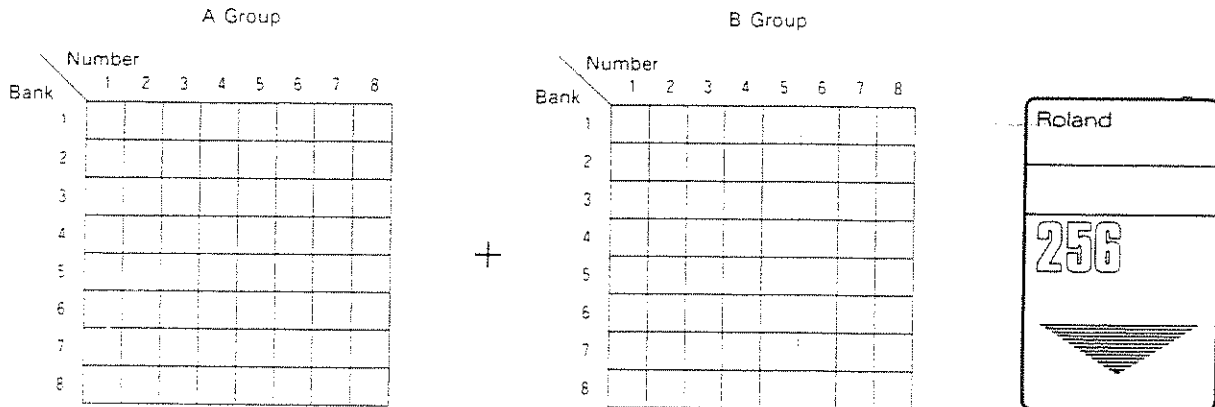

Internal : 128 Patches

Memory Card : 128 Patches

For selecting a Patch, the following buttons are involved. Patch selection is not executed unless the NUMBER button is pressed. If you wish to change only the Number of a Patch, simply press the relevant NUMBER button.

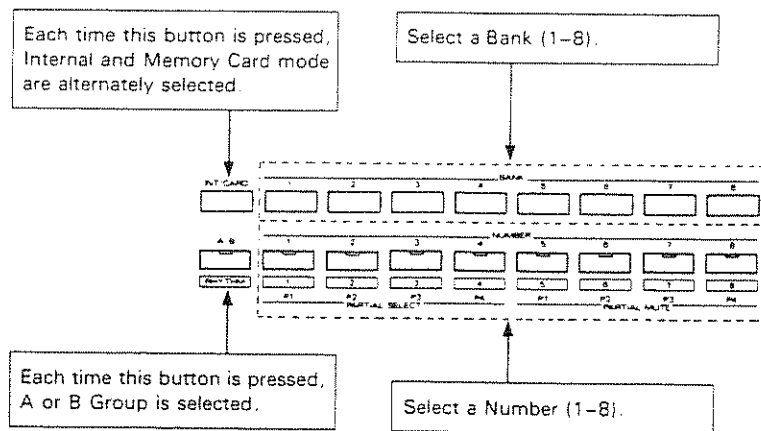

<Display>

When the Internal mode is selected, "I" is shown, and when the Memory Card is selected "C" is shown.

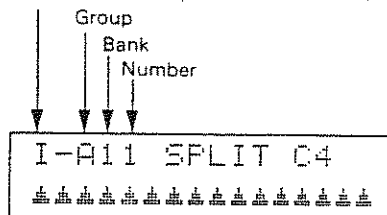

[Display]

The Display shows some of the data related to the selected Patch.

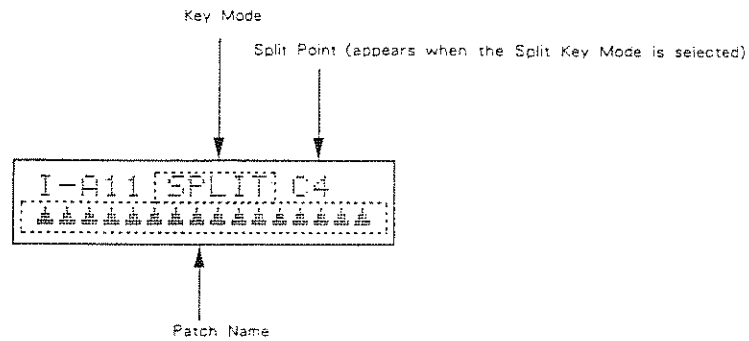

[Key Mode]

A pair of Tone are assigned to a Patch.
The Key Mode determines how to play these Tones.

- WHOLE : Only the Upper Tone is played
- DUAL : Upper and Lower Tones are mixed.
- SPLIT : The Keyboard is divided into two sections at a Split point. Upper and Lower Tones are played in different sections.

*The maximum number of voices which can be played simultaneously changes depending on the setting of the Patch, or whether the Rhythm section is playing or not.

If you wish to check what Tones are assigned to the Patch, press either of the DISPLAY buttons. Each time the button is pressed, the Display changes.

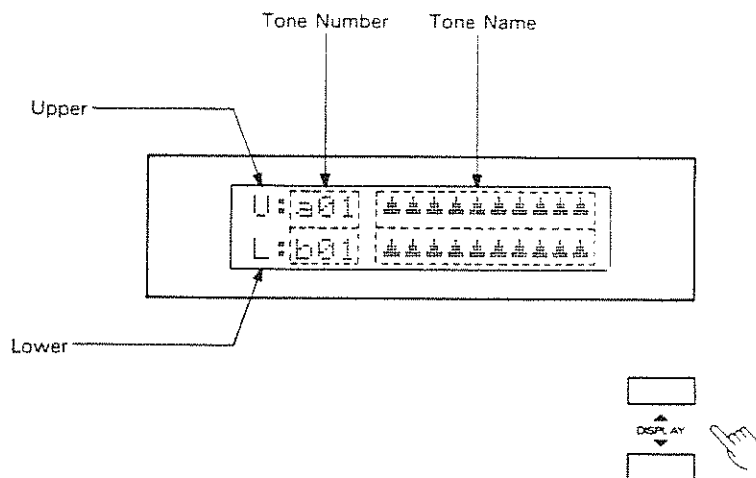

[Memory Card]

A memory card can store Rhythm data as well as the Sound data of Patches (Timbres) and Tones.

*A brand new memory card (M-256D, M-256E) does not contain any data at all, so it cannot be used unless an appropriate Saving procedure (see page 189 in the Volume 2) is taken for copying the entire data in the internal memory onto the memory card. This also applies to a memory card that contains data other than the D-20's.

Step 1 To use a Patch on a memory card, insert the memory card into the Card Slot in the correct direction.

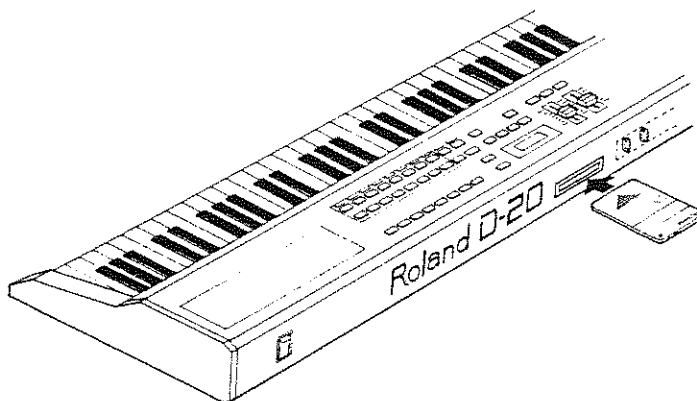

Step 2 Using the INT/CARD button, select CARD.

*If a memory card is not connected properly or not connected at all, the Display will show as below, and the CARD cannot be selected.

Card Not Ready

*If you use a memory card that contains data other than that of the D-10 or D-20, the Display will show as below for a while, and the CARD cannot be selected. (Regarding the D-110, only the Key assignment for Timbres/Tones/Rhythm setup is compatible with the D-20 in the Multi Timbral mode.)

Illegal Card

There are two types of memory cards :

ROM Card

Data on a ROM card cannot be edited as it is not erasable. The optional sound libraries are ROM cards.

RAM Card

Data on a RAM card can be edited. This type features a memory back-up system supported by a battery. The optional memory card (M-256D, M-256E) is a RAM card. Use this for saving the sound data you have programmed.

3. Performance Controlling Functions

During live performance, you can control the sound using the following performance controlling functions.

a. Bender Lever

Using the Bender Lever, you can change the pitch, or create vibrato effects.

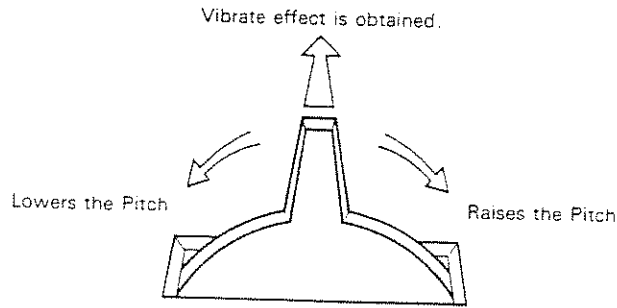

*The depth of the bender has been set differently for each Patch so that it will match the sound, therefore, the effect varies depending on the Patch you select.

b. Velocity

Velocity refers to dynamics, controlling volume, pitch and timbre. This allows piano-like performance.

*The depth of the velocity has been set differently for each Patch so that it will match the sound, therefore, the effect varies depending on the Patch you select.

c. Hold

"Hold" is the function that allows the sound to be held even after the key is released. This function can be controlled by the pedal switch connected to the Pedal Hold Socket.

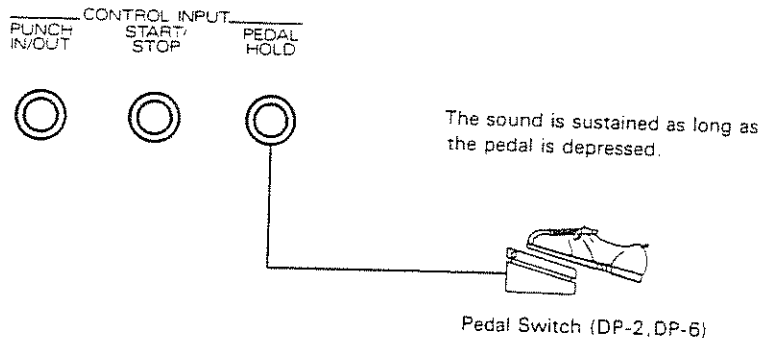

4. Rhythm Play

You can play rhythm patterns or rhythm tracks on the built-in rhythm machine and play the keyboard to the rhythm. Also, it is possible to play rhythms from the keyboard.

*The above function is also attainable in the Multi Timbral mode.

a. Track Play

At power-up, the Rhythm Machine defaults to the Rhythm Track playing mode.

*When performance data is recorded in the built-in sequencer, sequencer data can be played by taking the similar procedure.

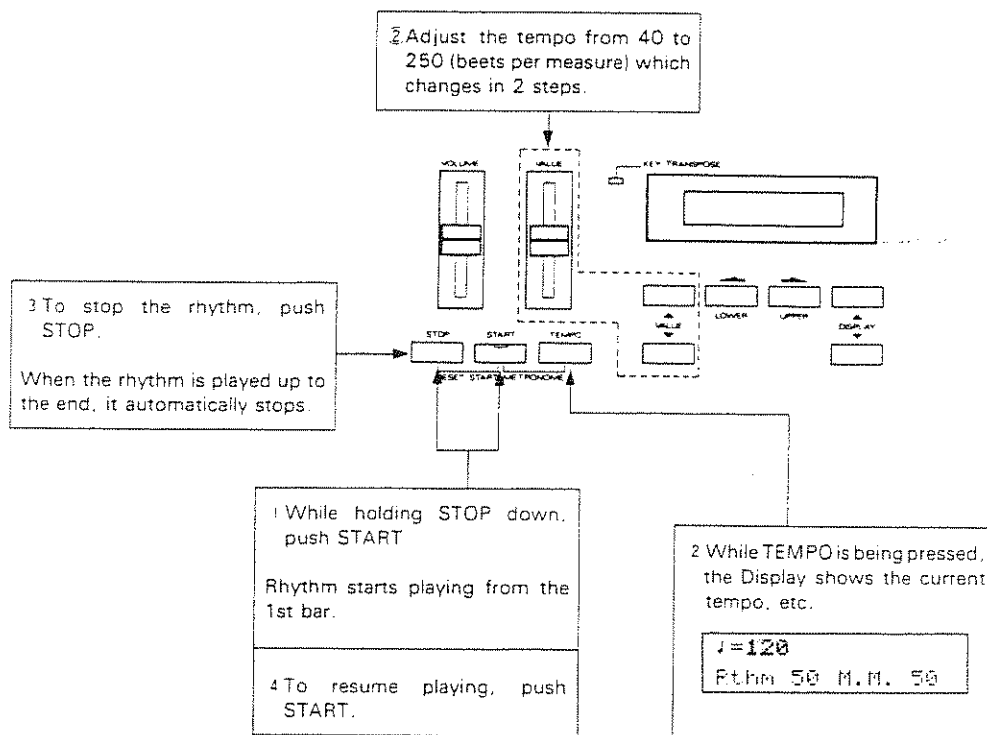

Starting (or stopping) the rhythm can also be controlled by a pedal switch connected to the Start/Stop Socket.

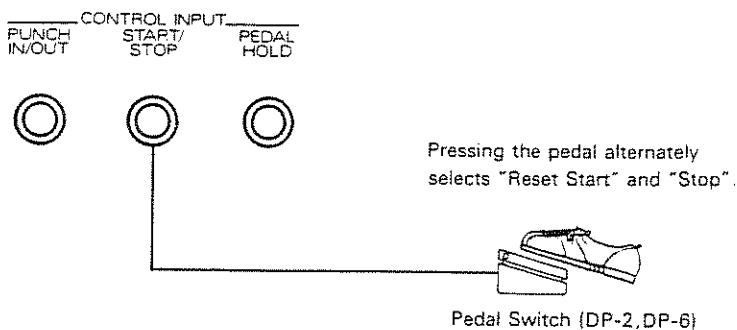

[Level Adjustment]

The volume of the rhythm can be changed as follows.

*The volume you have set is retained even after the unit is turned off.

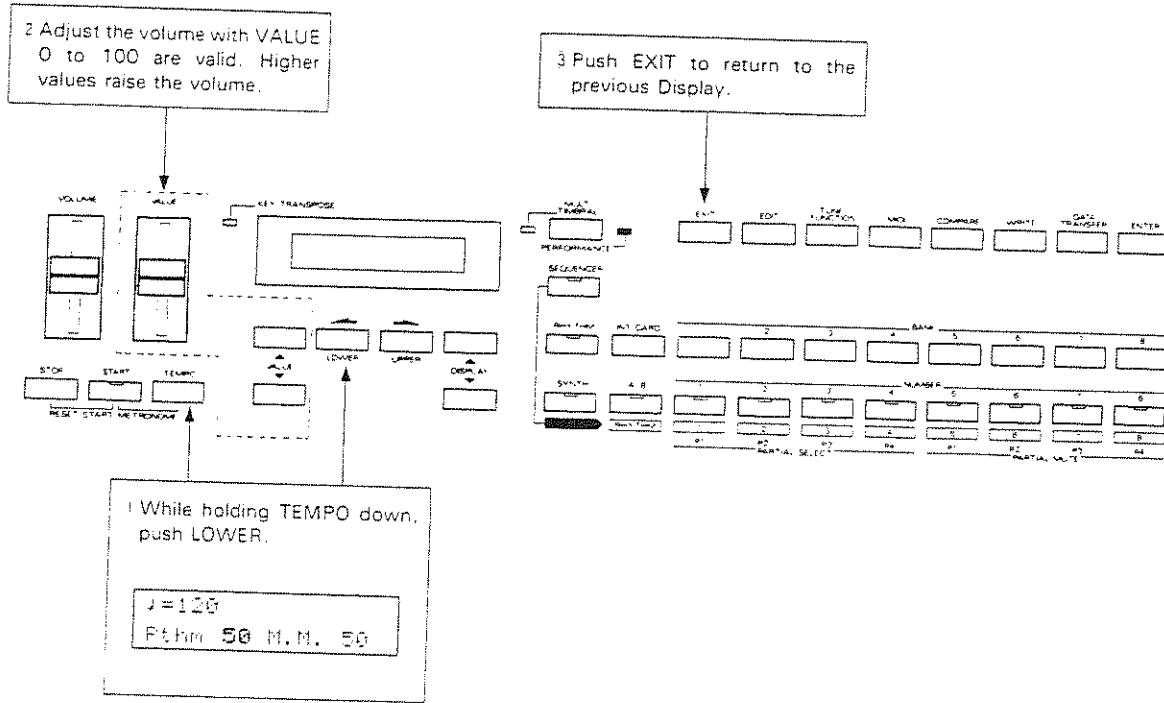

b. Rhythm Mode

The Rhythm mode turns the D-20 into a rhythm machine, allowing you to change rhythm patterns or play a rhythm from the keyboard.

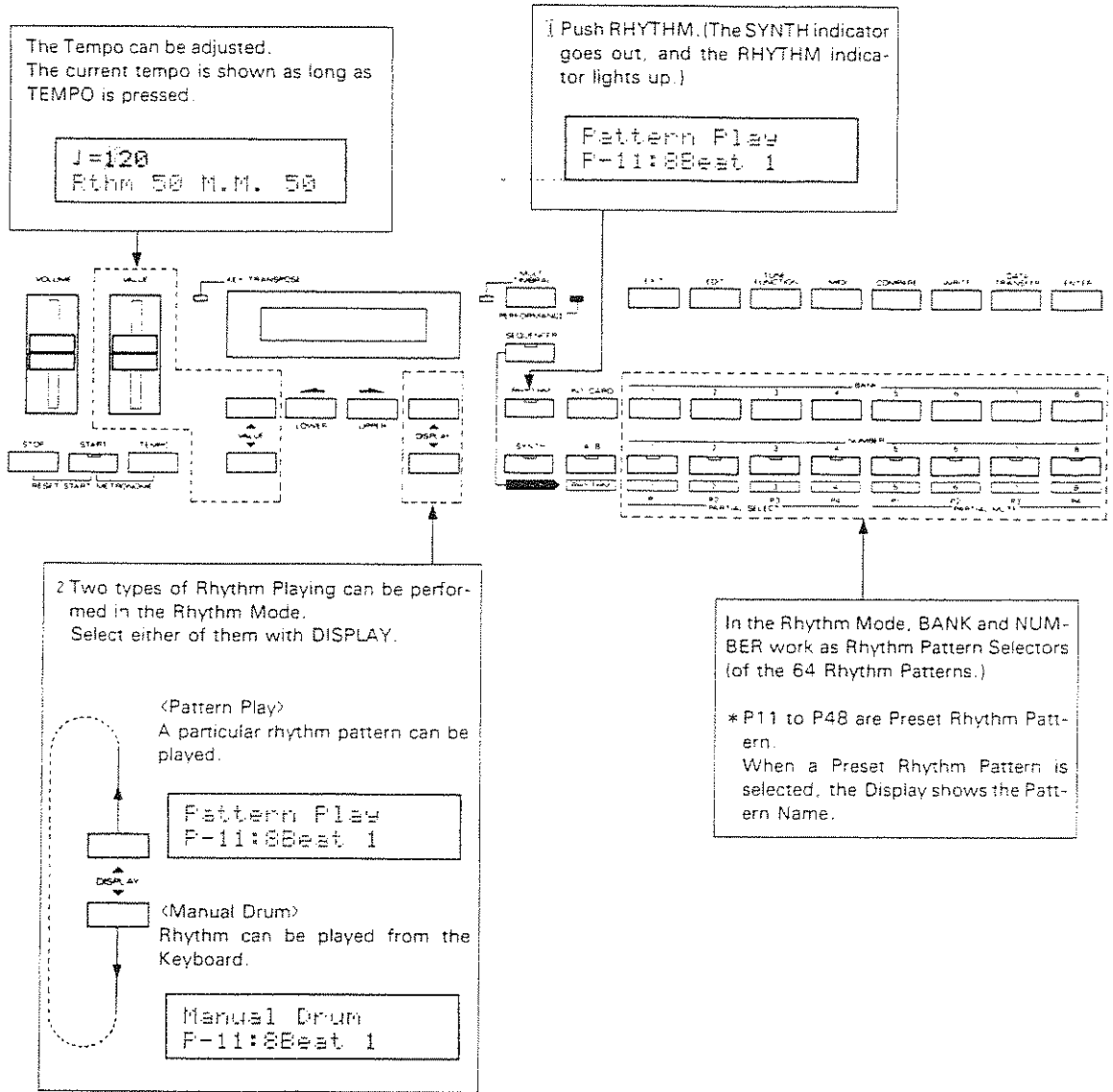

Preset Rhythm Pattern

Number Bank	1	2	3	4	5	6	7	8
1	8Beat 1	8Beat 2	8Beat 3	8Beat 4	8Beat 5	8Beat 6	Ballad	Reggae
2	16Beat 1	16Beat 2	16Beat 3	16Beat 4	16Beat 5	16Beat 6	Shuffle 1	Shuffle 2
3	Disco 1	Disco 2	Electric Pop 1	Electric Pop 2	Jazz 1	Jazz 2	Jazz 3	Jazz Walz
4	Samba 1	Samba 2	Samba 3	Bossanova 1	Bossanova 2	Mambo	Merengue	Rumba

[Pattern Play]

The Pattern Play mode allows you to play the keyboard while a certain Rhythm pattern is being played. The Patch selected before the RHYTHM button was pressed is played from the keyboard.

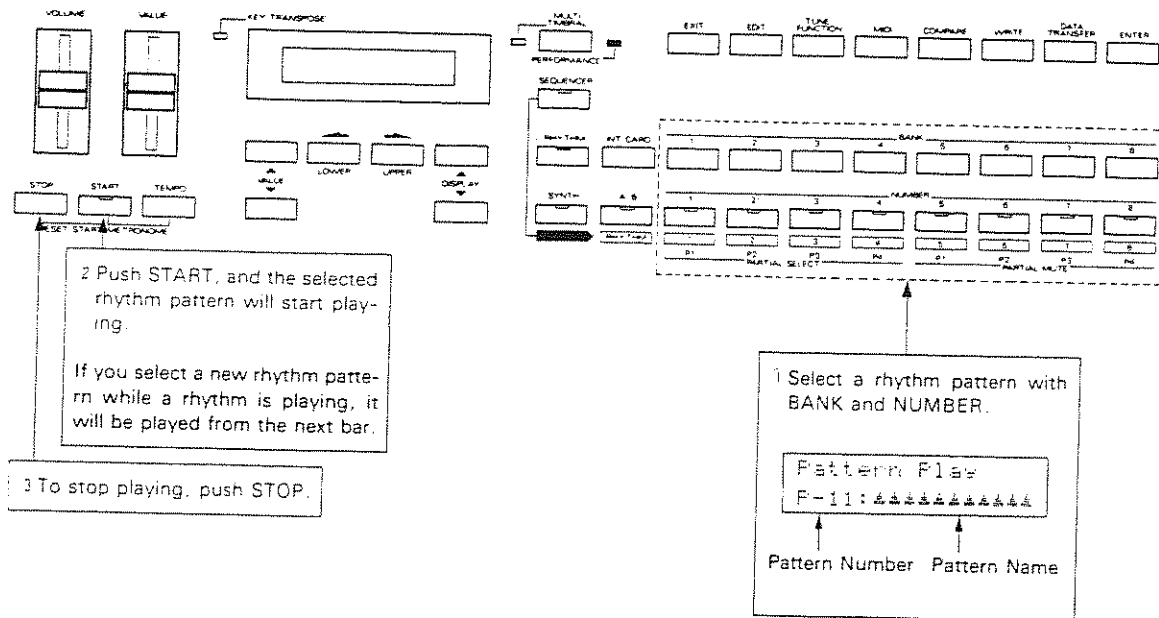

[Manual Drum]

In the Manual Drum mode, a rhythm can be played with the D-20's keyboard. Pressing the START button will play the rhythm pattern currently shown in the Display, so that you can play the keyboard to the rhythm.

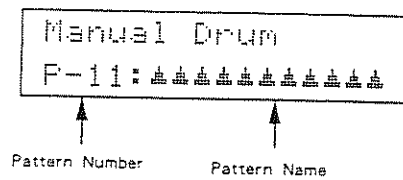

Rhythm Tones have been assigned to the keyboard by the manufacturer as shown right. Playing a key will play the corresponding Rhythm Tone.

r63	Native Drum-3	C7
r62	Native Drum-2	
r61	Native Drum-1	
r09	Ride Cymbal (short)	
r34	High Tom Tom-3	
r06	Crash Cymbal (short)	
r35	Middle Tom Tom-3	
r02	Closed High Hat-2	
r36	Low Tom Tom-3	
r24	Snare Drum-6	
r23	Snare Drum-5	C6
r22	Snare Drum-4	
r16	Bass Drum-4	
r17	Bass Drum-3	
r60	Bell	
r59	Wood Block	
r37	High Pitch Tom Tom-1	
r58	Triangle	
r38	High Pitch Tom Tom-2	
r57	Castanets	
r27	Brush-2	C5
r26	Brush-1	
r56	Claves	
r12	Cup (mute)	
r55	Quijada	
r54	Long Whistle	
r53	Short Whistle	
r52	Maracas	
r51	Cabasa	
r50	Low Agogo	
r49	High Agogo	C4 (Middle C)
r48	Low Timbale	
r47	High Timbale	
r46	Low Conga	
r45	High Conga	
r44	High Conga (mute)	
r43	Low Bongo	
r42	High Bongo	
r19	Ride Cymbal (mute)	
r21	Snare Drum-3	
r07	Crash Cymbal (mute)	C3
r41	Cowbell	
r14	Splash Cymbal	
r40	Tambourine	
r11	Cup	
r13	China Cymbal	
r08	Ride Cymbal	
r31	High Tom Tom-2	
r05	Crash Cymbal	
r28	High Tom Tom-1	
r32	Middle Tom Tom-2	C2
r03	Open High Hat-1	
r29	Middle Tom Tom-1	
r04	Open High Hat-2	
r33	Low Tom Tom-2	
r01	Closed High Hat-1	
r30	Low Tom Tom-2	
r20	Snare Drum-2	
r39	Hand Clap	
r18	Snare Drum-1	
r25	Rim Shot	
r16	Bass Drum-2	
r15	Bass Drum-1	

*The Key assignment or the volume of the Rhythm Tones can be altered, if you like. See page 80 "Rhythm Setup" in the Volume 2.

*To move the keyboard sound range, take an appropriate transposing procedure (page 33).

5. Metronome

The D-10 features a metronome which can be used for practicing the keyboard or for programming rhythm data.

If you wish to turn on only the metronome, push the START button while holding the TEMPO button down.

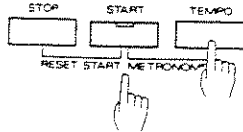

[Volume Adjustment]

The volume of the metronome can be adjusted as shown below.

*The volume you have set here will be retained even after the unit is turned off.

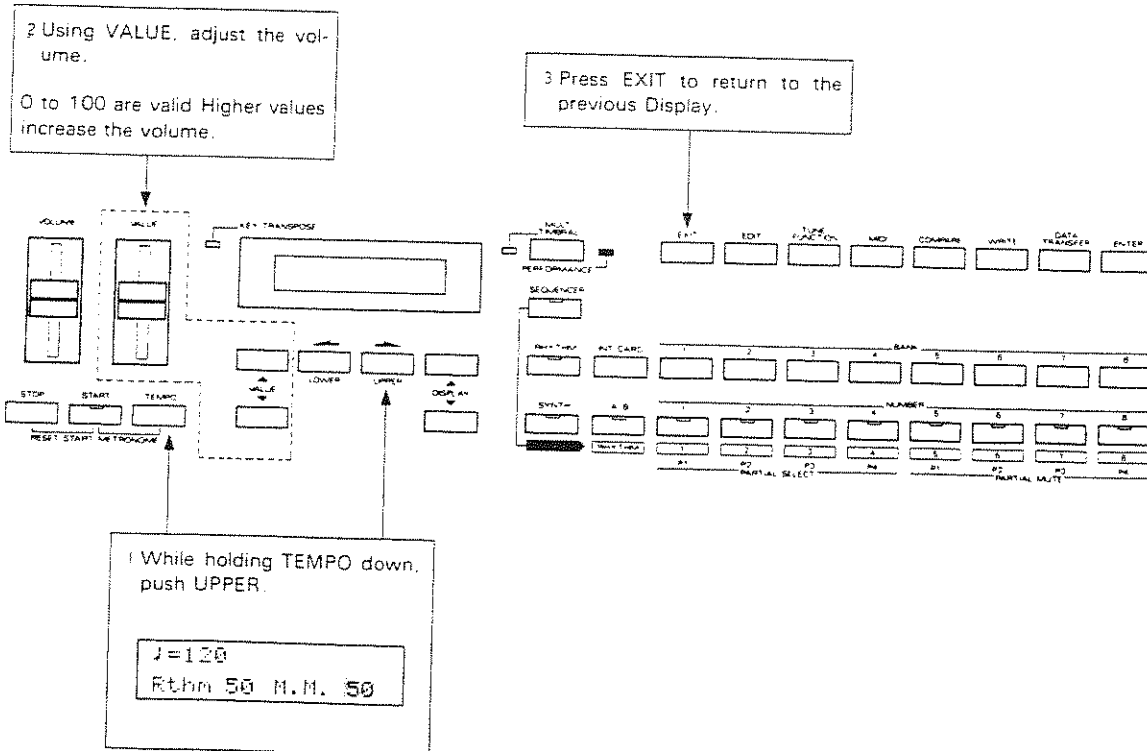

[Beat Setting]

You can change the beat of the metronome as shown below.

*The beat you have set will be retained even after the unit is turned off. While in recording, the rhythm will play in its own beat regardless of the beat set here.

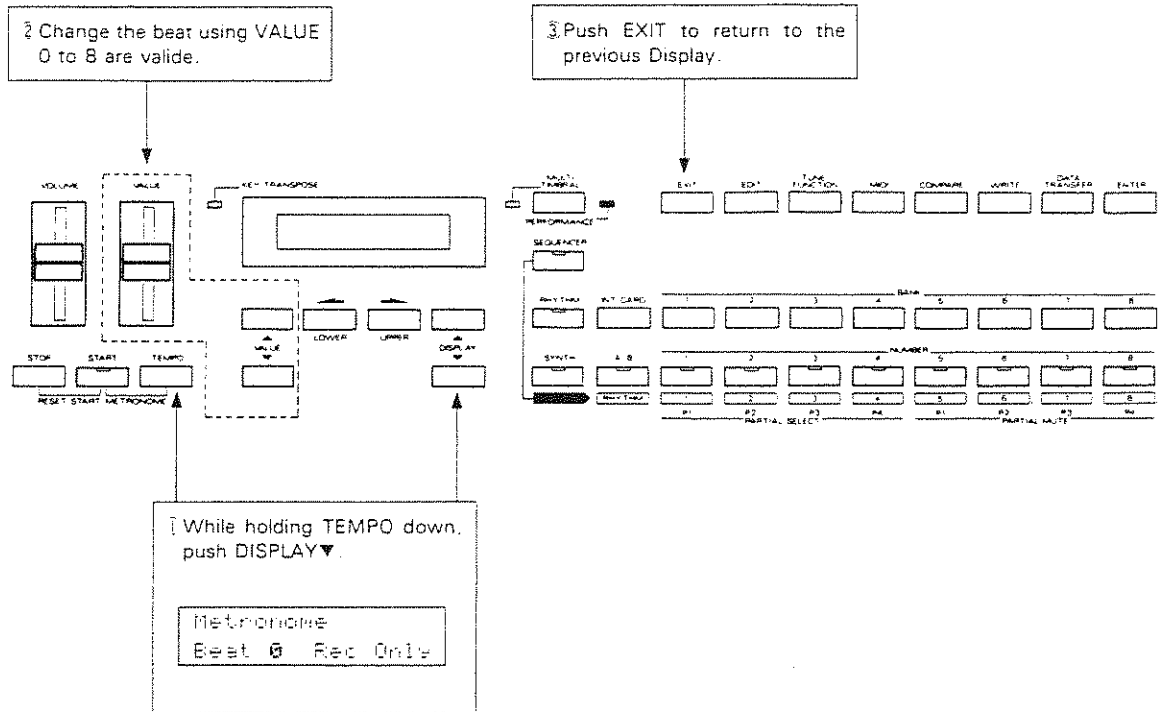

[Playing the Metronome with the rhythm performance]

To play the metronome with the rhythm performance, change the Metronome modes as shown below.

*The Metronome mode you have set here will be retained even after the unit is turned off.

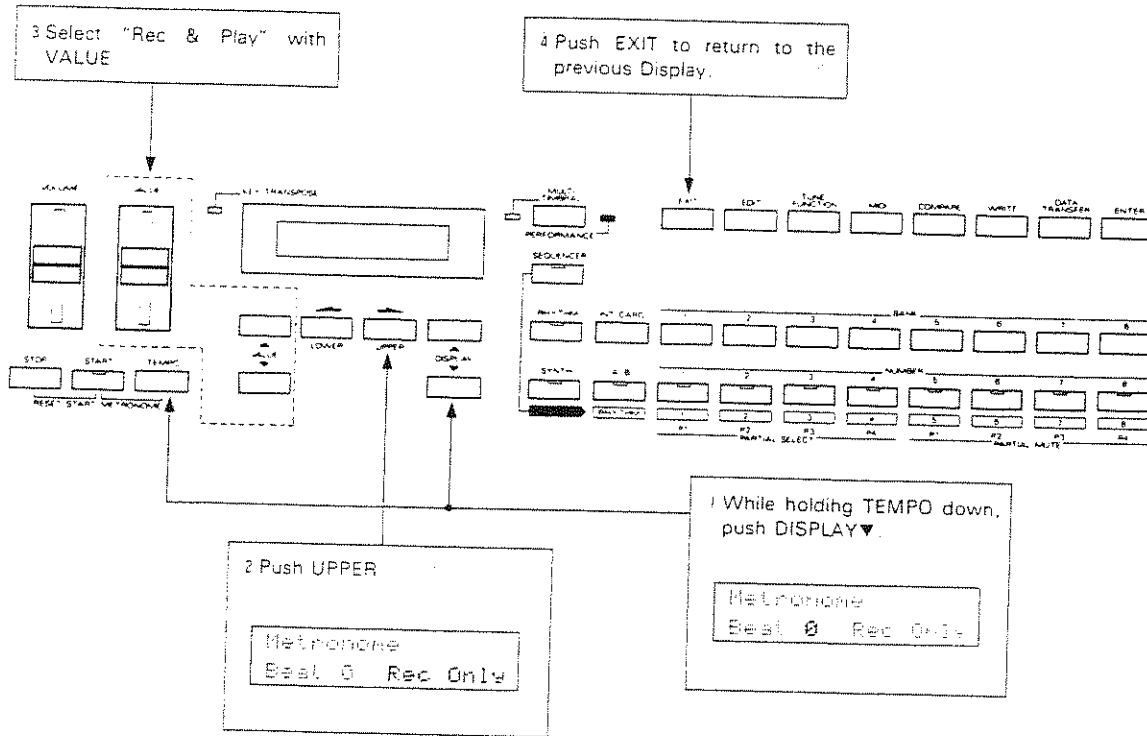

6. Master Tuning

Master Tuning adjusts the pitch of the D-20 to that of other musical instruments.

*The Master Tuning value you have set will be retained even after the unit is turned off.

*A Tone which uses a PCM sound may not be correctly tuned by the Master Tuning function.

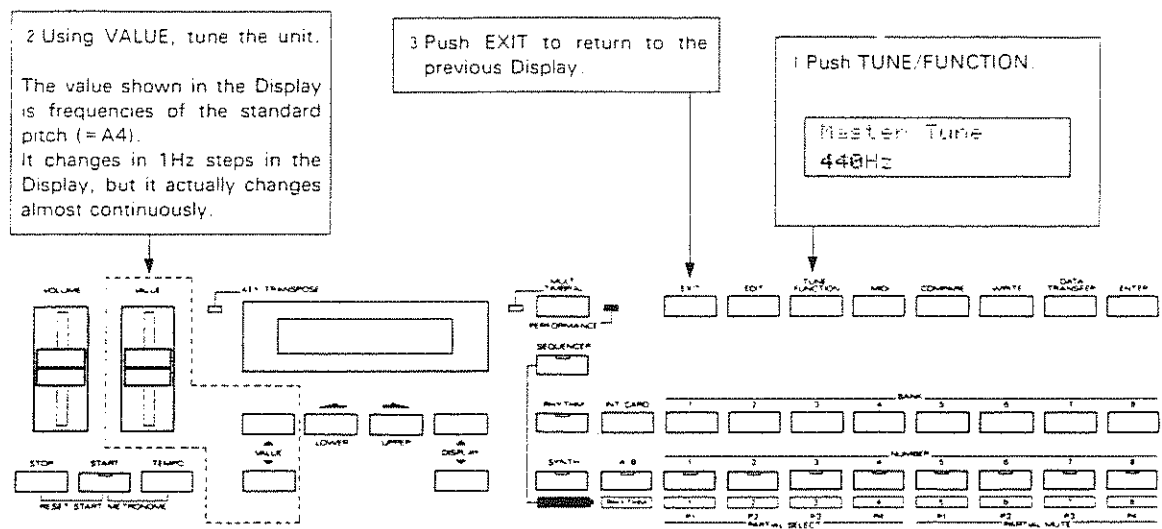

7. Key Transpose

The Key Transpose function transposes the entire keyboard in semi-tone steps, allowing you to play the same keyboard in different keys.

*The Key Transpose value you have set will be retained even after the unit is turned off.

*The Key Transpose function does not work in the Rhythm Setup or Rhythm Pattern programming mode.

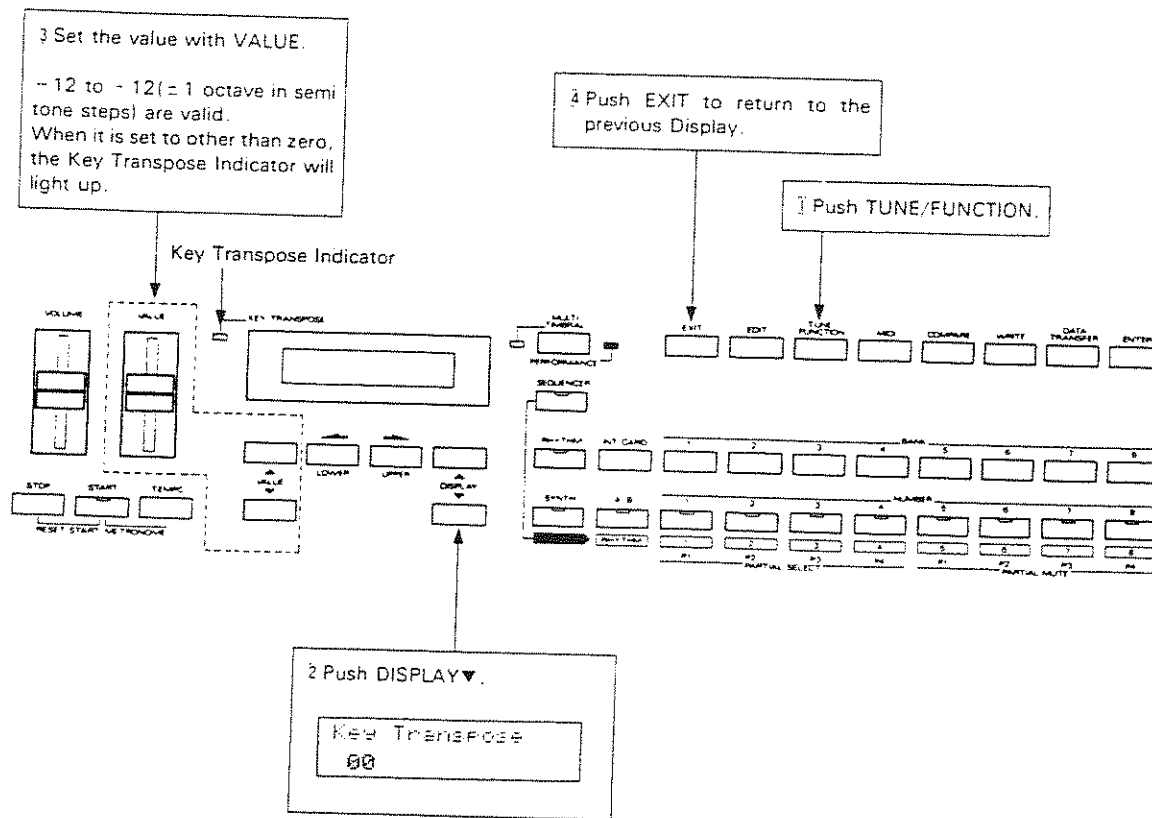

5 ROM PLAY MODE

Eight different songs are programmed in the D-20 in order to demonstrate the effects of the Multi Timbral function. Playing these preprogrammed songs is called ROM PLAY. When playing these songs, please use a stereo amplifier if possible, to obtain the best effect of the Multi Timbral functions.

[Procedure]

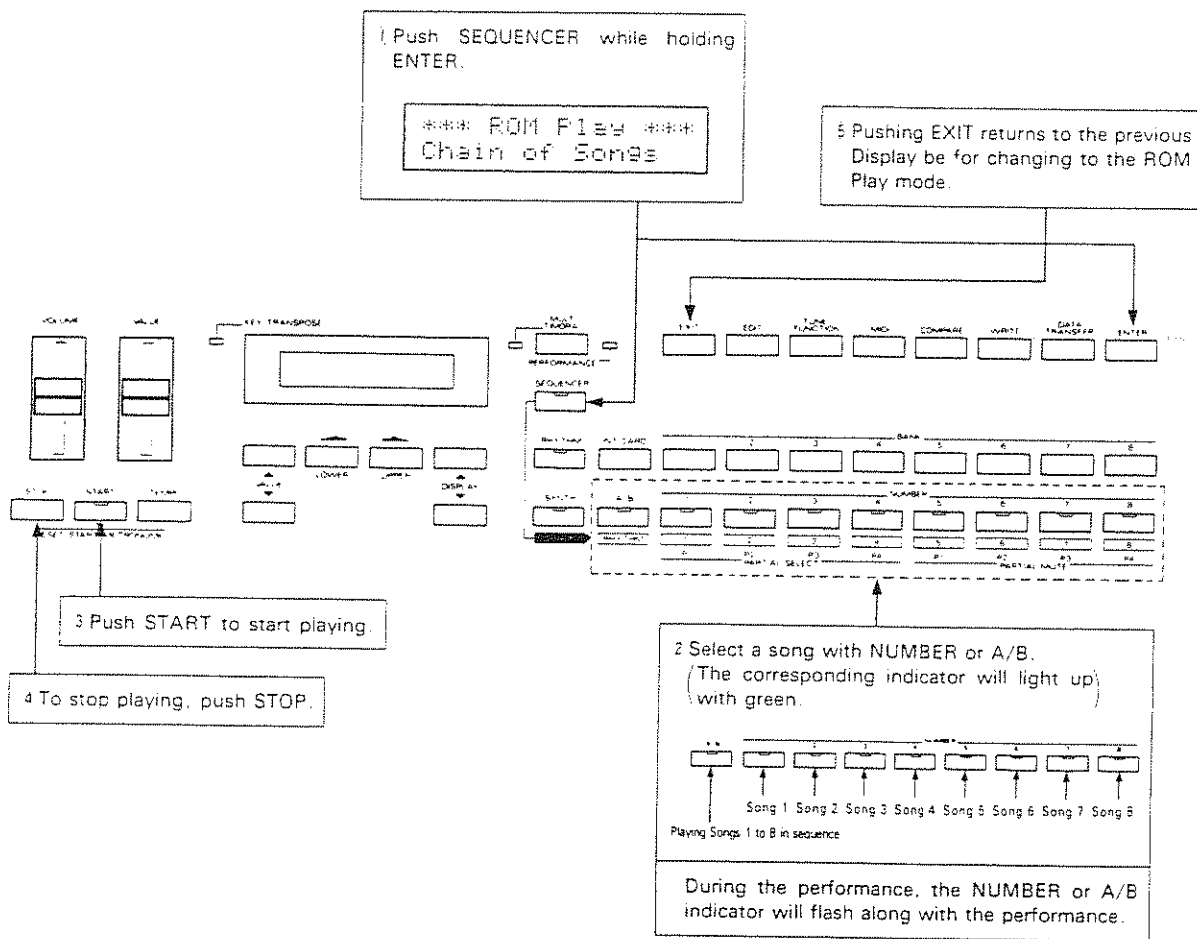

Song Number	Song Name	
1	Macho Memory	Music by Eric Persing © 1988 by Eric Persing
2	Jah May Kah !	Music by Amin Bhatia © 1988 by Amin Bhatia
3	Sugar Plum	Composed by Tchaikovski Arranged by Amin Bhatia
4	My Brother	Music by Adrian Scott © 1988 by Adrian Scott
5	Folk	Music by Amin Bhatia © 1988 by Amin Bhatia
6	Bumble Dee	Composed by Rymsky-Korsakow Arranged by Amin Bhatia
7	Mergatroid	Music by Eric Persing © 1988 by Eric Persing
8	Dinner Set	Music by Adrian Scott © 1988 by Adrian Scott

*During ROM Play, you cannot play the keyboard or use the controls such as a bender.

*The performance data of the ROM Play is not sent through the MIDI OUT Connector.

6 SPECIFICATIONS

D-20 : Multi Timbral Linear Synthesizer with
a built-in Multi Track Sequencer

● **Keyboard**

61 Keys (with Velocity)

● **Sound Source**

LA System

Maximum Voices : 32 Voices

● **Synthesizer Section**

Patches : 128

Timbres : 128

Preset Tones : 128

Programmable Tones : 64

Preset Rhythm Tones : 63

● **Rhythm Section**

Setups : 85 types (C1 to C8)

Preset Rhythm Patterns : 32

Programmable Rhythm Patterns : 32

Maximum number of notes to be
simultaneously recorded (Rhythm Pattern)
: 8

Maximum number of notes to be recorded
(in each Rhythm Pattern) : 96 notes

Maximum number of bars to be recorded
(Rhythm Track) : 500

● **Sequencer Section**

Maximum number of notes to be recorded :
approx. 16,000 notes

Maximum number of bars to be recorded :
500

● **Memory Card (M-256D, M-256E)**

Patches : 128

Timbres : 128

Tones : 64

Rhythm Patterns : 32

Rhythm Track : One Song

Rhythm Setups : One Set

● **Floppy Disk (Double Density Track)**

Memory Capacity : approx. 35,000 notes (Song
Data)

[Front Panel]

Volume Knob

Value Knob

Stop Button

Start Button

Tempo Button

Value Button × 2

Cursor Button × 2

Display Button × 2

Mode Button

Sequencer Button

Rhythm Button

Synth Button

Internal/Card Button

A/B Button

Bank Button × 8

Number Button × 8

Exit Button

Edit Button

Tune/Function Button

MIDI Button

Compare Button

Write Button

Data Transfer Button

Enter Button

Bender Lever

[Display]

2 lines, 16 letter (back-lit)

[Indicators]

Start Indicator

Key Transpose Indicator

Multi Timbral Indicator

Performance Indicator

Sequencer Indicator

Synth Indicator

Rhythm Indicator

A/B Indicator

Number Indicator × 8

[Rear Panel]

Output Socket × 2

Headphones Socket

Start/Stop Socket

Hold Socket

Punch In/Out Socket

MIDI Connectors (IN, OUT, THRU)

Dimensions :

1,014 (W) × 301 (D) × 106 (H) mm
39-15/16" × 11-7/8" × 4-3/16"

Weight :

10.1kg/22 lb 4 oz

Consumption :

25W

Accessories :

Owner's Manual (Volume 1, Volume 2)

Quick Operation Table

Sound Chart

Guide Book for MIDI

Connection Cable (LP-25)

Floppy Disk (3.5" 2DD)

[Options]

Memory Card (RAM) M-256D, M-256E

Carrying Case SHC-1

Programmer PG-10

Stereo Headphones RH-100

Pedal Switch DP-2/DP-6

MIDI/SYNC Cable

MSC-07/15/25/50/100

CONTENTS

Volume 2

① Multi Timbral Mode	3	③ Edit	80
1. Concept of		1. Rhythm Setup	80
the Multi Timbral Mode	3	a. Editing Procedure	80
2. Basic Procedures	5	b. Writing Procedure	85
a. Changing Displays	5	2. Patch and Timbre	86
b. Timbre Selection	7	a. Patch	86
c. Function Setting	9	1) Editing Procedure	86
1) MIDI Function Setting	9	2) Patch Parameters	88
2) Tune/Function Setting	12	b. Timbre	96
		1) Editing Procedure	96
② Recording	17	2) Timbre Parameters	98
1. Preparation for Recording	17	c. Writing Procedure	101
a. Performance Data	17	1) Writing into	
b. Setting the Metronome	19	the internal memory	101
1) Selecting		2) Writing onto	
the Metronome Mode	19	a Memory Card	105
2) Volume Adjustment	20	3. Tone	107
c. Recording Procedure	21	a. The Basic Concept of a Tone	107
d. Making Rhythm Patterns	23	1) Partial and Structure	107
1) Editing Procedure (I)	23	2) Partial	111
2) Editing Procedure (II)	29	b. Editing Procedure	114
3) Writing Procedure	32	1) Editing Procedure	114
2. Recording	36	2) Editing Functions	119
a. Basic Procedure	36	c. Tone Parameters	122
1) Sequencer Mode	36	1) Common	122
2) Rhythm Track	39	2) WG Pitch/Modulation	125
3) Tracks 1 to 7	45	3) WG Form/Pitch ENV	128
4) Track 8	49	4) Pitch ENV	133
b. Editing Performance Data	53	5) TVF Frequency/ENV	135
1) Recording from any bar	53	6) TVF ENV	139
2) Punch In/Punch Out	57	7) TVA Level	141
3) Over-dubbing	59	8) TVA ENV	144
4) Clear	66	d. Writing Procedure	146
5) Erase	70	1) Writing into	
6) Quantize	74	the internal memory	146
c. Song Name	76	2) Writing onto a memory card	148
3. Sequencer Play	77		
a. Play Mode	77		
b. Sequencer Mode	78		

4	Applications of the D-20	150	7	Trouble Information	209
1.	Performance Mode	150	1.	Before Calling for Service	209
a.	Using the Sequencer	150	2.	Error Messages	212
1)	Structure of the Sequencer	150			
2)	How to Use the Sequencer	152	8	Appendix	219
b.	Using MIDI Devices	152	1.	Tables	219
1)	How MIDI Messages run	153	a.	Performance Mode	219
2)	Examples	155	b.	Multi Timbral Mode	220
3)	MIDI Function Setting	157	c.	Tone Parameters	221
4)	MIDI Channel Setting		d.	PCM Sounds	222
	for each Part	162	e.	Preset Rhythm Tones	224
5)	Sync	164	f.	Preprogrammed Rhythm Setup	224
2.	Multi Timbral Mode	166	g.	Preset Tones	225
a.	Using MIDI Devices	166	h.	Others	226
1)	How MIDI Messages run	166	2.	Sample Notes	227
2)	Examples	168	a.	Patch/Timbre	227
3)	Sync	170	b.	Tone	228
b.	Recording from		c.	Rhythm Setup	229
	an external sequencer	172			
5	Data Transfer	175			
1.	Copying with a Floppy Disk	175			
a.	Formatting	177			
b.	Saving	180			
c.	Loading	184			
d.	Deleting	186			
2.	Copying with a Memory Card	188			
b.	Saving	189			
c.	Loading	192			
3.	Data Transfer with MIDI	195			
6	LA System	200			
1.	What is sound made of ?	200			
2.	Understanding Sound Synthesis	204			
a.	Structure	204			
b.	The Editing Procedure	208			

1 MULTI TIMBRAL MODE

When using the D-20 in the Multi Timbral mode, please read the supplied "MIDI Guide book" before this owner's manual.

1. Concept of the Multi Timbral Mode

The following picture shows how the performance messages move in the Multi Timbral mode.

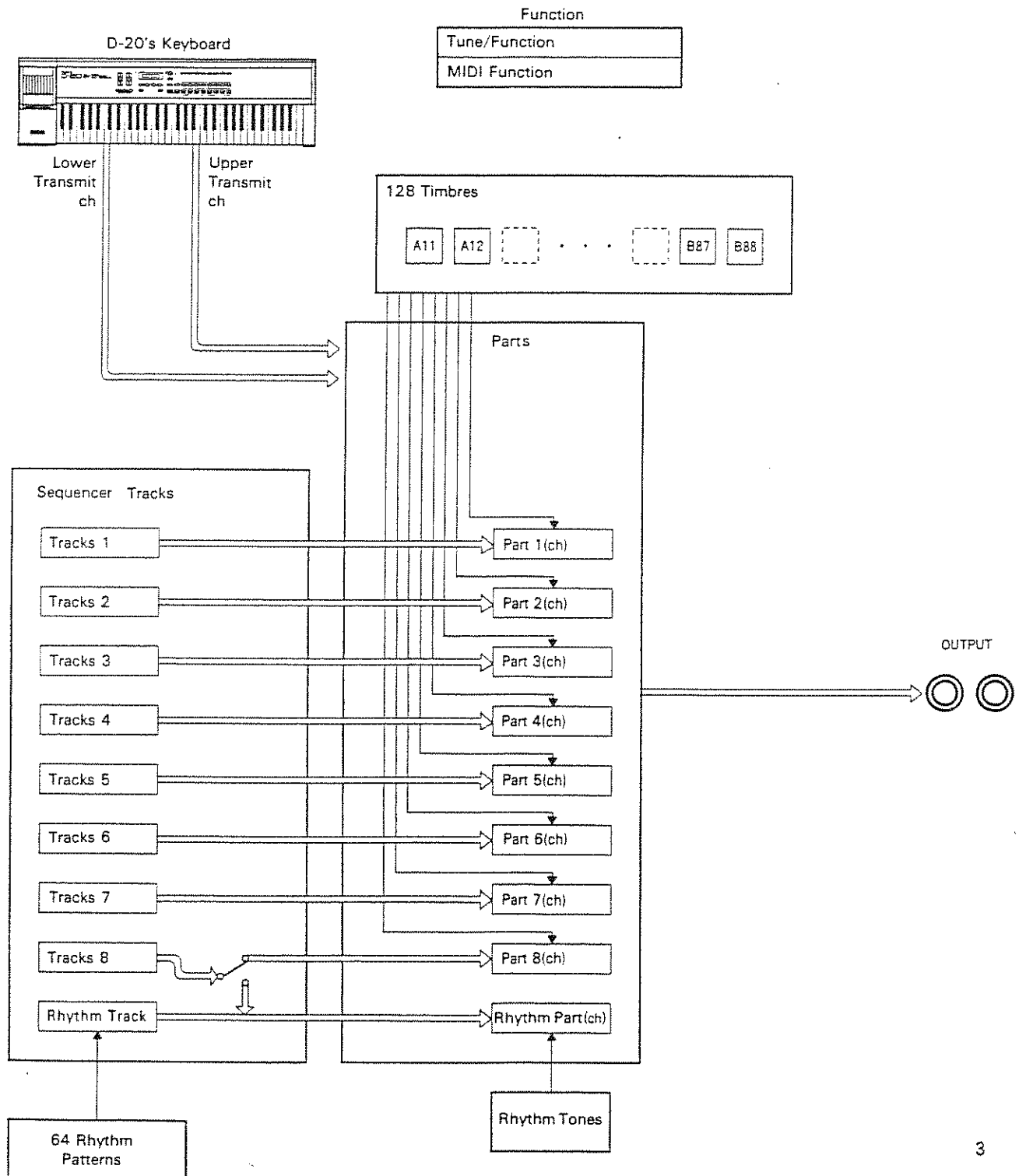

● Part

Each of the 9 Parts has an independent MIDI channel, and therefore can be considered as 9 separate MIDI sound modules. Any of the 128 Timbres can be assigned to each Part. Also, up to 85 Rhythm Tones can be assigned to the Rhythm Part.

● Keyboard

The keyboard of the D-20 is an independent section. The keyboard can be divided into two sections at any key (=Split Point), and each section has a different MIDI transmit channel. This fact enables you to play a different Part in a different keyboard range. Keyboard performance information is transmitted through the MIDI Output on a separate Keyboard Transmit channel for each keyboard section.

● Sequencer

The sequencer section features 9 Tracks for recording performance data. Performance data recorded in a Track plays the corresponding Part. Track 8 can also record rhythm performance with real time recording if the Rhythm Part is selected in the Recording mode.

● Function

Functions involve parameters which determine how the system works, e.g. how each Part is played by MIDI messages, etc.

2. Basic Procedures

The effect of the Multi Timbral function is conspicuous when used with the built-in Sequencer. Before you start recording, let us explain the basic concept of the Multi Timbral mode and the necessary procedure for performing the sequencer data. After recording data in the sequencer, Read "sequencer" on page 77.

Push the Mode Button to select the Multi Timbral mode.

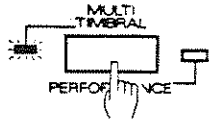

a. Changing Displays

In the Multi Timbral mode, you can check the setting of each Part or keyboard by changing the Displays.

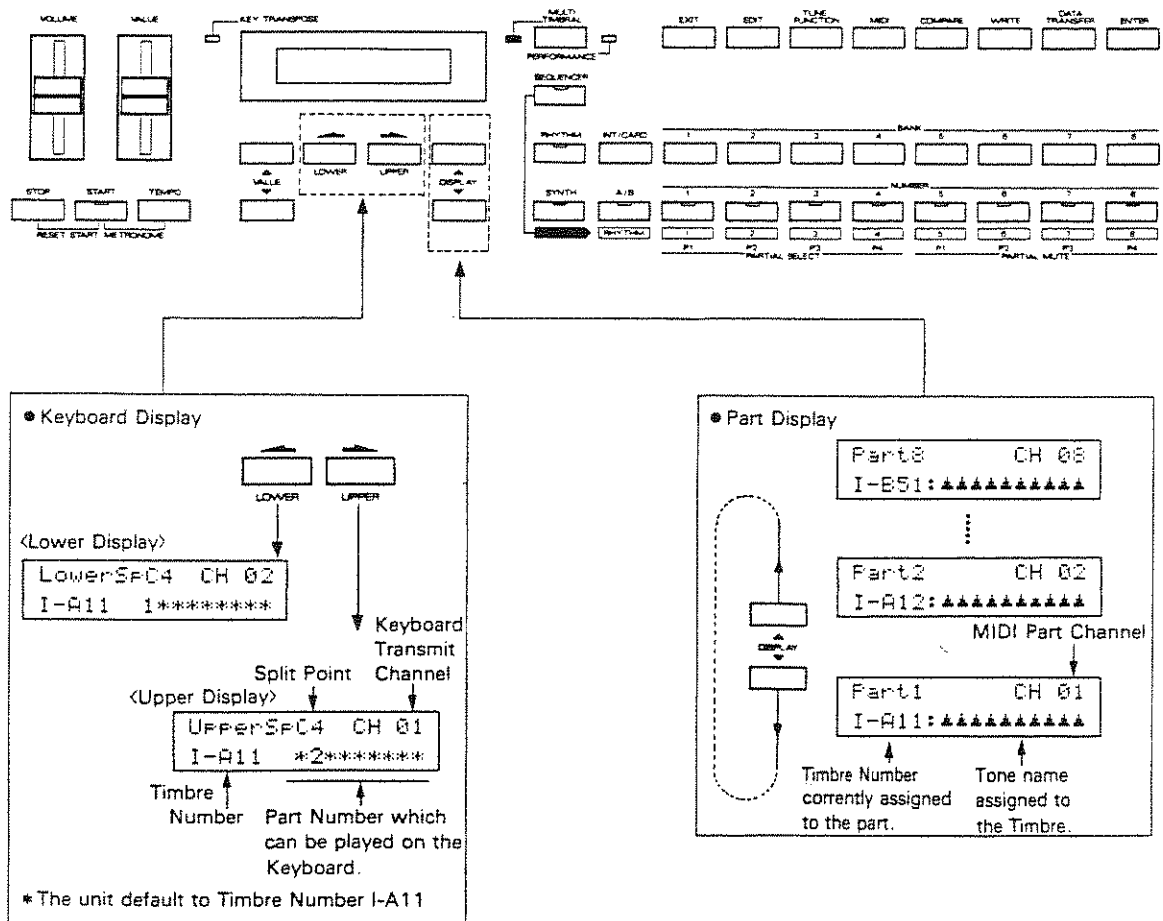

*Just like a Patch in the Performance mode, a Timbre can be called by assigning a Group (A/B), Bank (1-8) and Number (1-8).

Channels and the Split Point on the keyboard are preprogrammed by the manufacturer as shown below. So, playing the upper section of the keyboard will produce the sound of Part 1, and the lower section will produce the sound of Part 2.

<Keyboard Transmit Channel> <MIDI Channel of a Part>

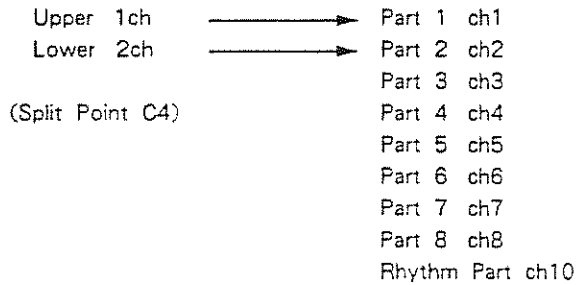

*To change the MIDI channel assigned to each Part or keyboard transmit channel, see page 9 "MIDI Function Setting".

*To change the Split Point on the keyboard, see page 12 "Tune/Function Setting".

How each Part is being played can be seen by the A/B and NUMBER indicators. (The indicators that correspond to the Part currently being played are lit.)

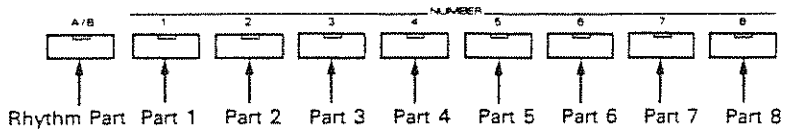

b. Timbre Selection

You can change the Timbre assigned to each Part to another one as shown below.

[Timbre Selection on the D-20]

<Timbre selection in each part>

Changing the Timbre assigned to each Part do as follows.

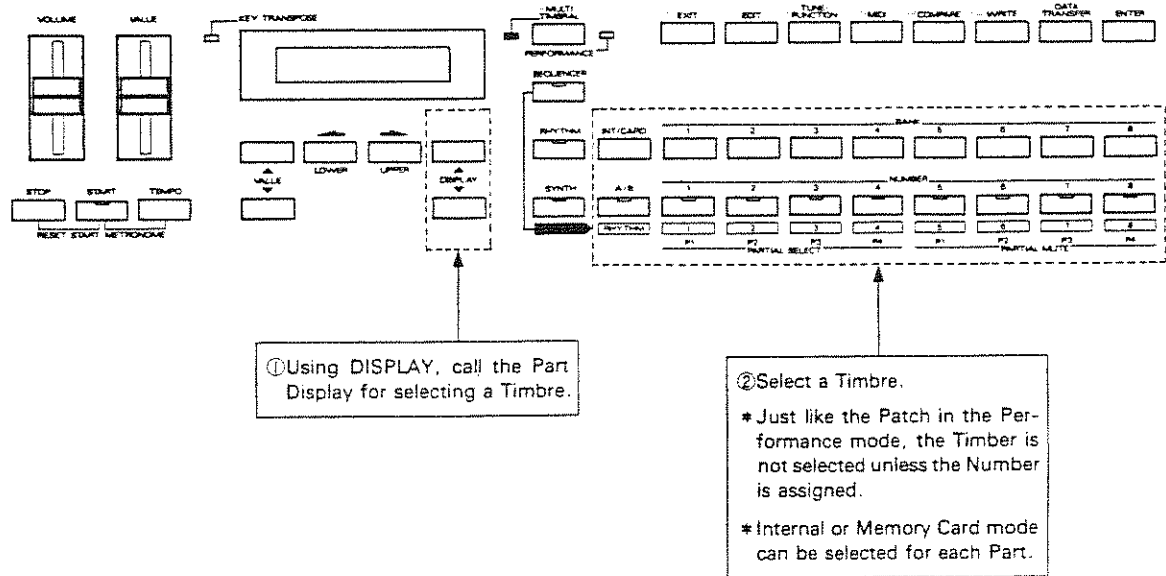

*When the unit is turned off, the Timbres assigned to all the Parts are returned to the Internal.

*The above Timbre selecting procedure does not cause corresponding Program Change messages to be transmitted from MIDI OUT.

<Timbre Selection for the Keyboard>

The following procedure will allow you to change the Timbre assigned to the Part you are playing from the keyboard.

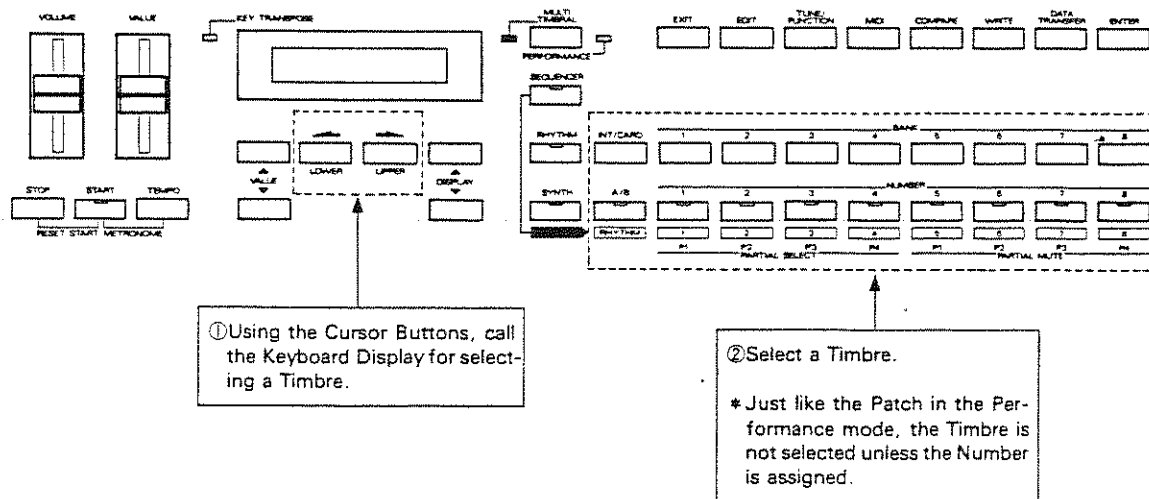

*The above Timbre selecting procedure cause corresponding Program Change message to be transmitted from MIDI OUT.(See page 167.)

*The number shown in the Keyboard Display is not the Timbre number used in the Part you have assigned. It is the corresponding Program Change number. Therefore, changing the Timbre in the Part Display does not change the Timbre number of the Keyboard Display.

*When the unit is turned off, the Timbres assigned to all the Parts are returned to the Internal.

c. Function Setting

1) MIDI Function Setting

Switch the unit to the Multi Timbral mode (the Multi Timbral Indicator is lit) before taking the following MIDI function setting procedures.

*The changes you have made will be retained in memory even after the unit is turned off, except in a few cases.

[Editing Procedure]

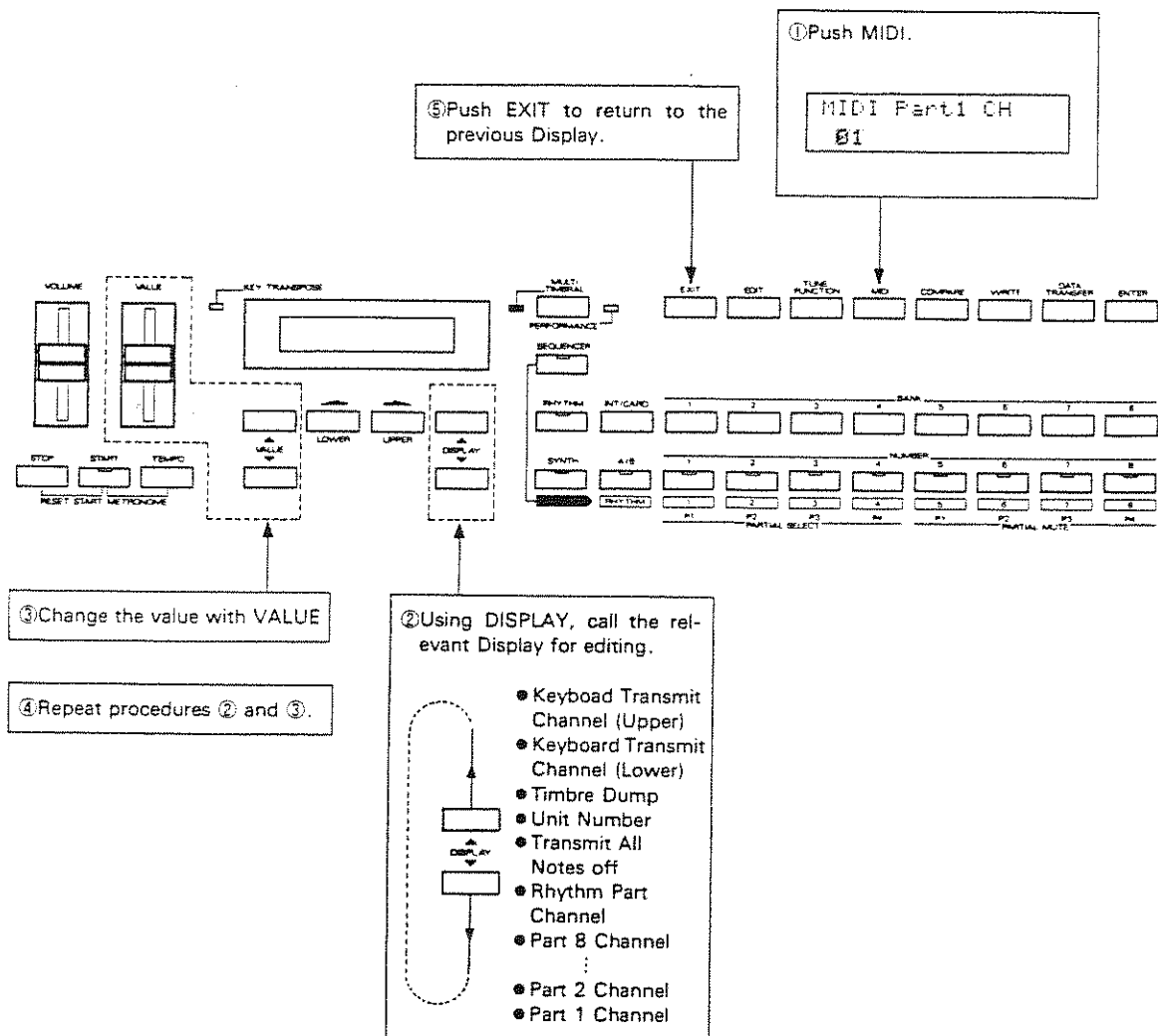

[MIDI Functions]

● Part Channel

```
MIDI Part1 CH
01
```

The Display of other is the same.

The MIDI channel of each Part can be set from 1 to 16.

*If you change the MIDI channel of the Rhythm Part, the Rhythm channel in the Performance mode (See page 158) will be automatically changed.

● Keyboard Transmit Channel

Lower

```
MIDI Lower TxCH
02
```

Upper

```
MIDI Upper TxCH
01
```

The MIDI transmit channel of each keyboard section (upper or lower) can be set from 1 to 16.

● Transmit All Notes OFF

```
MIDI TxAll N-Off
ON
```

If you do not want to transmit All Notes OFF messages, set this to OFF.

*The Transmit All Notes OFF setting is available for the muted performance data of sequencer and in the Performance Mode.

*The Transmit All Notes OFF setting will return to ON when the unit is turned off.

● Unit Number

MIDI Exclu Unit# 17

A Unit Number is a number used to identify an external device instead of the MIDI channel number, when data is received or transmitted using Exclusive messages (only for the Roland ID number). So, it is possible to send or receive Exclusive messages by matching the Unit numbers of two devices. OFF and 17 to 32 are valid, and at OFF, Exclusive messages cannot be communicated. When using a programmer, be sure not to select OFF.

*Even when sending or receiving Exclusive messages on a MIDI channel, do not set this to OFF but any number from 17 to 32.

*The Unit Number you have set is retained even in the Performance mode.

*The Unit Number you have set will be automatically returned to 17 when the unit is turned off.

● Timbre Dump

MIDI Timbre DUMP OFF

The Timbre Dump function transmits the sound data of a certain Timbre using Exclusive messages. Using this function, sound data can be recorded in a sequencer together with performance data. In this way, the original Timbre will always be retrieved even after it is edited on the D-10. Depending on the Display, how the data is transmitted varies. That is, changing the Timber in the Keyboard Display will transmit data on the keyboard transmit channel, and doing the same thing in the Part Display will transmit the data with the Unit number.

*The Timbre Dump can transmit data only the Timbre is changed with the panel operation.

*If you change the value of the Timbre Dump, the Patch Dump setting (see page 161) in the Performance mode also will be changed automatically.

*The Timbre Dump you have set will automatically return to OFF when the unit is turned off.

2) Tune/Function Setting

This involves Master Tuning, Reverb, output balance of each Part, etc. Before taking the following procedures, set the unit to the Multi Timbral mode (the Multi Timbral Indicator is lit).

*The changes you have made will be retained in memory even after the unit is turned off, except in a few cases.

[Editing Procedure]

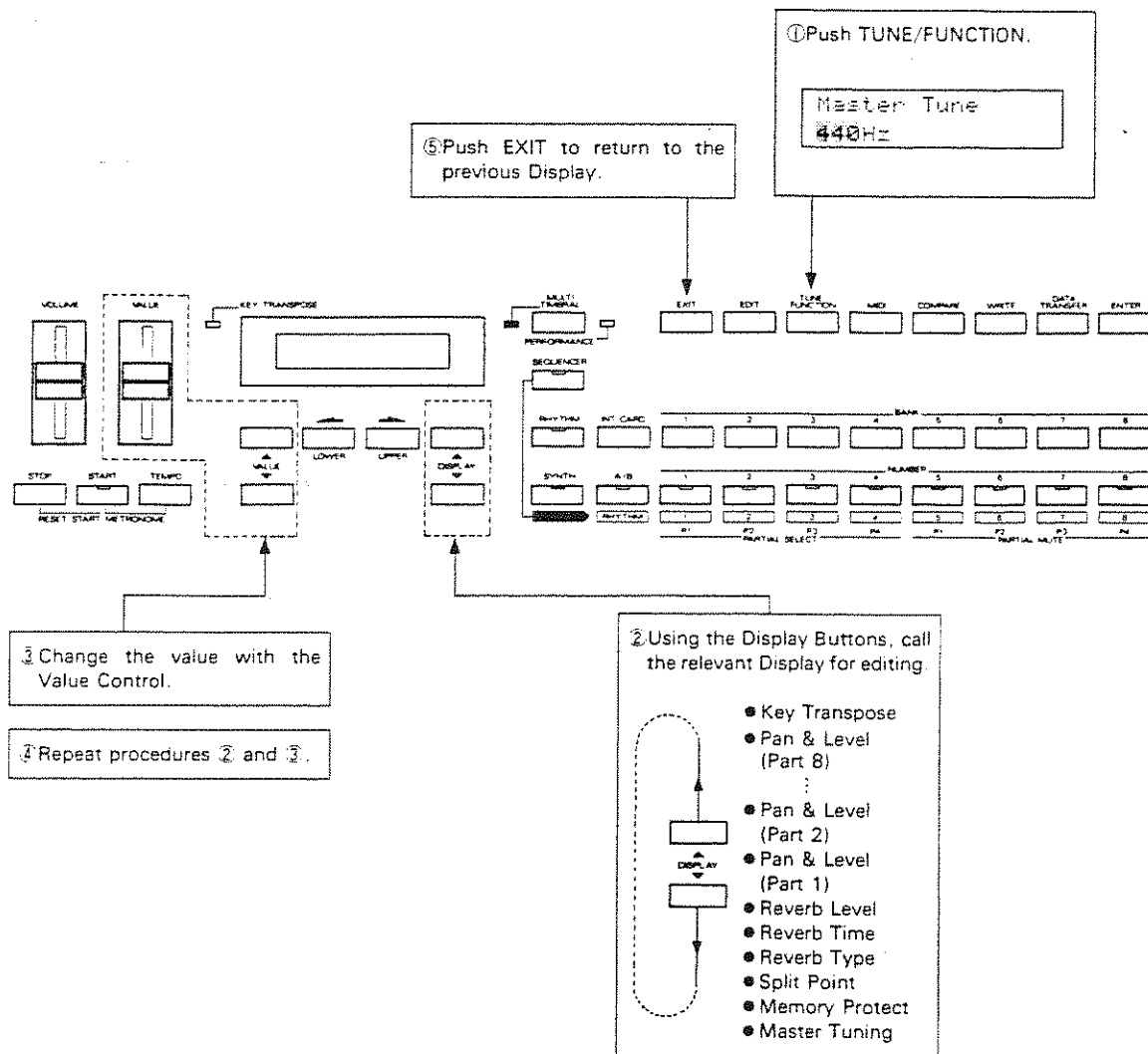

[Tune/Functions]

● Master Tuning

```
Master Tune
440Hz
```

The pitch of all the Parts can be set within the range of about 428 to 453Hz (frequency of the standart pitch "A4"). The value in the Display changes in 1Hz steps, but the pitch actually changes almost continuously.

*The Master Tune value you have set is retained even in the Performance mode.

*The pitch of a Tone that uses a PCM sound may not be changed by the Master Tuning function.

● Memory Protect

```
Memory Protect
ON
```

The Memory Protect function prevents data written in the internal memory of the unit from being erased accidentally. This should be set to OFF for writing or data transfer procedures that write data into the internal memory. Otherwise, set it to ON.

*The Memory Protect setting is retained even in the Performance mode.

*The Memory Protect setting will be automatically returned to ON when the unit is turned off.

● Split Point

```
Split Point
C4
```

This determines the key where the keyboard is divided into two sections, upper and lower. C2 to C#7 are valid.

*Middle C is C4.

● Reverb Type

Reverb Type
 1

This selects one of the 8 Reverb Types or OFF. At OFF, no reverb effect is obtained.

Number	Reverb Type
1	Small Room
2	Medium Room
3	Medium Room
4	Large Hall
5	Plate
6	Delay 1
7	Delay 2
8	Delay 3
OFF	No Reverb

*Reverb ON or OFF can be selected for each Timbre or each Rhythm Tone. (See page 98 "Timbre Parameters" and page 80 "Rhythm Setup".)

● Reverb Time

Reverb Time
 01

This sets the reverberation time. 1 to 8 are valid, and higher values refer to longer reverb times. (When a delay effect is selected, the delay time changes.)

● Reverb Level

Reverb Level
 04

This sets the level of the reverb sound. 0 to 7 are valid, and higher values increase the level.

● Pan and Level

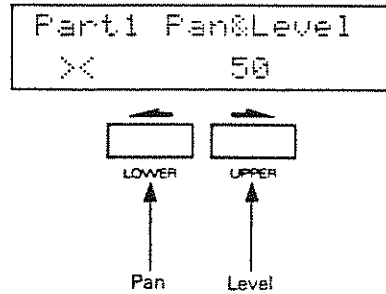

This sets the pan and level of Parts 1 to 8. Pan is positioning of the sound image output in stereo. Pan and Level adjust the output balance of each Part.

To set the Level, push the Cursor Button on the right (the value will flash). 0 to 100 are valid, higher values increase the volume.

To set the Pan, push the Cursor Button on the left (the value will flash). 7> to <7 are valid. At "><", center positioning is obtained. <7 is right and 7> is left placement.

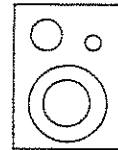
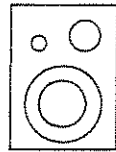

7> 6> 5> 4> 3> 2> 1> >< <1 <2 <3 <4 <5 <6 <7
Middle

*For adjusting the overall volume of the Rhythm, see page 23 "Track Play" in Volume 1. In the Rhythm section, the Pan and Level can be set individually for each Rhythm Tone. (See page 80 "Rhythm Setup".)

*Changing the Pan value may not affect the sound quite the way you expect in some Tones because of the Structure setting. (See page 109.)

*When using a Tone made using only one Partial, there are 8 possible panning positions.

● Key Transpose

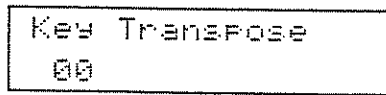

This function transposes the entire keyboard in semi-tone steps, allowing you to play the same keyboard in different keys. -12 to +12 (semi-tone steps, 1 octave) are valid. If the value is set to other than zero, the indicator of the Key Transpose will light up.

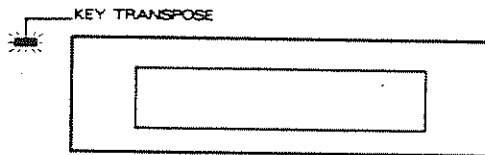

*The Key Transpose value you have set is retained even in the Performance mode.

*The Key Transpose function does not work in the Rhythm Setup or Making Rhythm Patterns.

2 RECORDING

The following will explain how to record performance data into the built-in Sequencer.

1. Preparation for Recording

The built-in Multi Track sequencer is ideal for use with the D-20's Multi Timbral mode.

*The performance data, except rhythm track data, you have recorded will be erased when the unit is turned off or a different data is recorded on the same track. To retain the data onto floppy disk, take the "Saving" procedure. (See page 180.)

*The Sequencer can also be used in the Performance mode, but the full effect cannot be obtained because of the structural difference of the sound sources. To use the Sequencer in the Performance mode, read "Using the Sequencer" on page 150, before recording performance data.

a. Performance Data

The Sequencer can record the following performance data.

→ Tracks 1 to 8

Key Messages : What key (=Key Number) is played, how strongly (=Velocity) and how much time (=Key On/Off)?

Sound Messages : What Timber or Patch is used (=Program Change Number)

Control Messages : Pitch Bender, Modulation, Hold, Volume and Pan

*The Timbres and Patches are numbered in exactly the same way, therefore, a Program Change number corresponds to both a Patch and Timbre. A Patch or Timbre is selected by a Program Change number depending on whether the Mutli Timbral or Performance mode is currently selected.

*The Internal or Memory Card modes can be selected only by operating the panel controls on the D-20. That is, the recorded Program Change numbers cannot change the memory modes. This means that even if a Timbre or Patch on a memory card is selected in recording, it cannot be played back unless you select the memory card mode by using the front panel controls on the D-20.

Normally, the Timbre or Patch needed for recording should be collected in the internal memory.

⇒ Rhythm Track

The rhythm patterns prepared in the internal memory can be recorded in the Rhythm Track.

Unlike a tape recorder, a sequencer does not record the sound itself but only the necessary messages (=performance data).

A sequencer plays the Timbre or Patch using the recorded performance data.

b. Setting the Metronome

The D-20 allows you to set how the Metronome should beep in rhythm pattern programming or sequencer recording.

1) Setting the Metronome Mode

This sets how to use the Metronome.

*The Metronome mode you have set will be retained even after the unit is turned off.

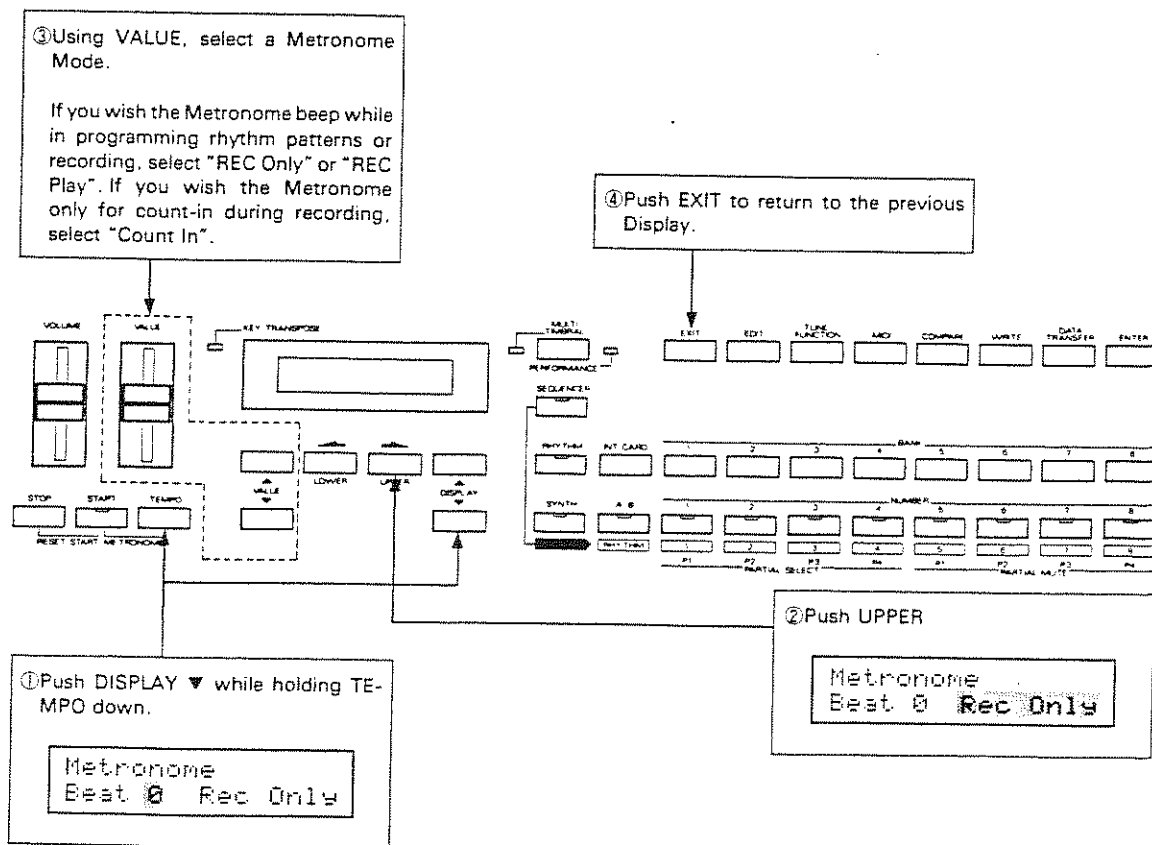

2) Volume Adjustment

The volume of the metronome can be adjusted as follows.

*The metronome volume you have set will be retained even after the unit is turned off.

② Using VALUE, adjust the volume.
0 to 100 are valid. Higher values increase the volume.

③ Press EXIT to return to the previous Display.

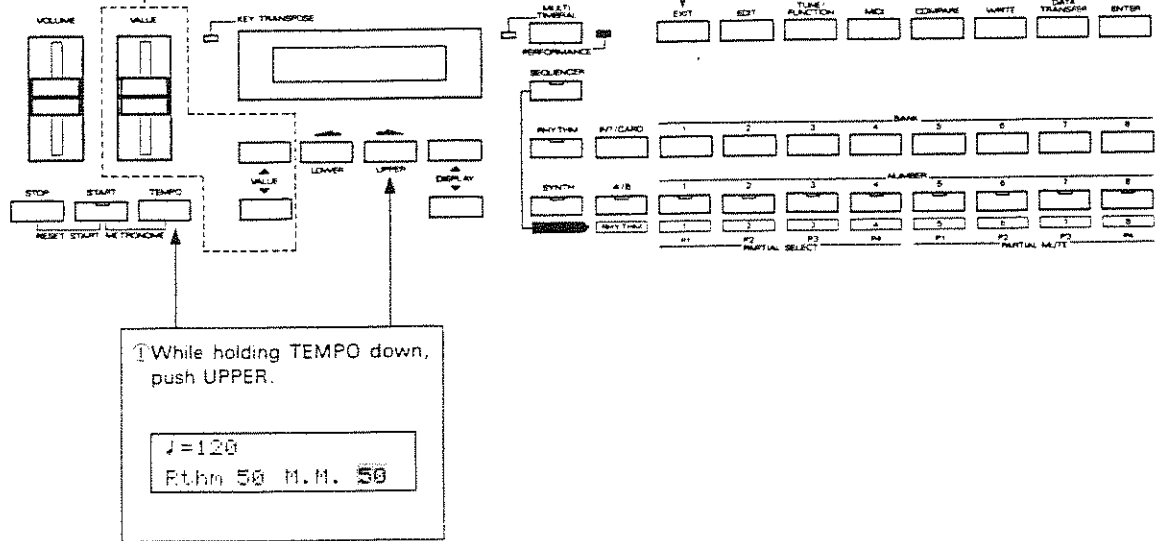

c. Recording Procedure

Step 1 Making Rhythm Patterns

You should prepare all the Rhythm Patterns which are to be used for making a Rhythm Track. Up to 32 Rhythm Patterns are user-programmable in real time recording. If you have a MIDI device such as a rhythm machine, it is possible to make rhythm patterns using the performance data of the rhythm machine.

Step 2 Recording the Rhythm Track

Using any of the preprogrammed patterns (32) or your original (32) Rhythm Patterns, you can record a song (or tune) in the Rhythm Track. Real time recording can be used in Track 8, which is useful for creating variations such as fill-ins, etc..

Step 3 Recording in Tracks 1 to 8

As you play the recorded Rhythm Track, add bass, backing, melody, etc, one by one, again using real time recording.

*The control messages of pan and volume can be recorded by using the Overdubbing function.

Step 4 Editing the recorded data

Data recorded in Tracks 1 to 8 can be edited using various editing functions.

○Re-recording from any bar you like.

○Editing a part of the recorded data by using the Punch In/Out function.

○Adding some more performance data to the existing data using the Overdubbing function. The Overdubbing function also allows volume and pan controls.

○The Clear function erases the entire performance data in each Track or all the Tracks including the Rhythm Track.

○The Erase Function can erase only performance messages such as Program Change or Pan and Volume in each Track.

○The Quantize function can correct timing differences of the key Message in each Track.

*The Quantize function may cause performance in correctness as Quantize function only adjust the Key Message. When the Program Change Message and Control Message is recorded into the track to be quantized, record these message using Overdubbing function after quantizeing.

Step 5 Saving the recorded data

Data recorded in a Track (except for the Rhythm Track) is erased when the unit is turned off. If you wish to retain the data, save it onto a floppy disk as explained on page 175 "Data Transfer".

*The Data Transfer function of the D-20 allows you to copy a block of data in the internal memory onto a floppy disk. However, if the data in the internal memory is modified for some reason, the recorded data will not be played back faithfully. To avoid this, normally, copy the entire data in the memory onto a floppy disk.

d. Making Rhythm Patterns

Preprogrammed Rhythm Patterns P-51 to 88 can be edited to make your original rhythm patterns. Before going to the rhythm track recording procedure, make your own rhythm patterns, if necessary. There are two methods for making rhythm patterns; by using the keyboard of the D-20 (Editing Procedure I), and by using performance data sent from an external device such as a rhythm machine (Editing Procedure II).

*If you wish to edit Rhythm Tones, see page 80 "Rhythm Setup".

1) Editing Procedure (I)

Rhythm patterns can be made by playing the keyboard of the D-20.

*The rhythm pattern you have made will be erased when a different rhythm pattern is selected or the unit is turned off. To retain the edited data, take the appropriate writing procedure as shown on page 32 "Writing Procedure".

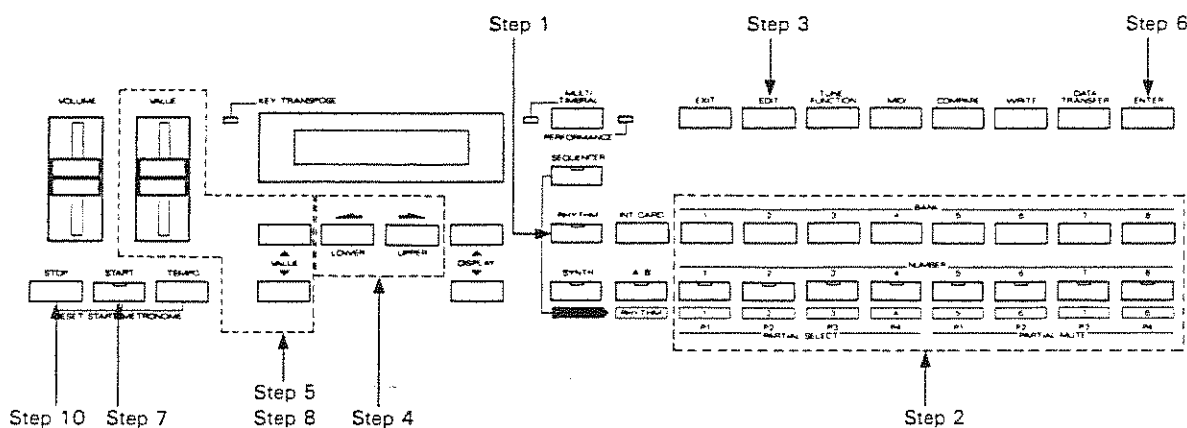

Step 1 Push the RHYTHM button.(The indicator lights up.)

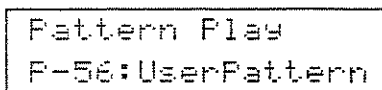

Step 2 Select a rhythm pattern number using the BANK and NUMBER buttons.

If you wish to make a rhythm pattern from scratch, select a rhythm pattern from 51 to 88. (Note that the selected rhythm pattern will be replaced with new data.)

If you wish to make a rhythm pattern by editing an existing one, select a source pattern.

*To hear the rhythm pattern you have selected, simply press the START button. (Before going to the next procedure, be sure to stop the rhythm by pushing the STOP button.)

Step 3 Push the EDIT button.

```

Edit P-56 Clear?
Yes      No
    
```

Step 4 If you wish to clear the entire rhythm pattern data, push the Cursor Button on the left. If not, push the Cursor Button on the right.

```

Edit P-56 Clear?
Yes      No
    
```

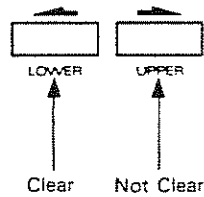

If you pushed the right Cursor Button, go to Step 7.

Step 5 Using the Value Control Knob, set the time signature of the rhythm pattern (from 1/4 to 8/4).

```

Edit P-56
Time 4/4 Enter
    
```

Step 6 Push the ENTER button.

```

Edit P-56          4/4
Qua OFF EraseOFF
    
```

Step 7 Push the START button.

Rhythm Tones are assigned to the keyboard as set in the SETUP.

*The Rhythm Tones have been pre-assigned by the manufacturer as shown on page 84 "Rhythm Setup".

- Step 8** Adjust the tempo with the Value Control Knob.
- Step 9** Make a rhythm pattern by playing the keyboard. By changing how hard you play the keyboard, velocity can be added.

If you wish to select a key that exceeds the maximum range of the keyboard, transpose the pitch of the keyboard using the DISPLAY buttons before assigning the key. When the keyboard is transposed, the Key Transpose Indicator lights up.

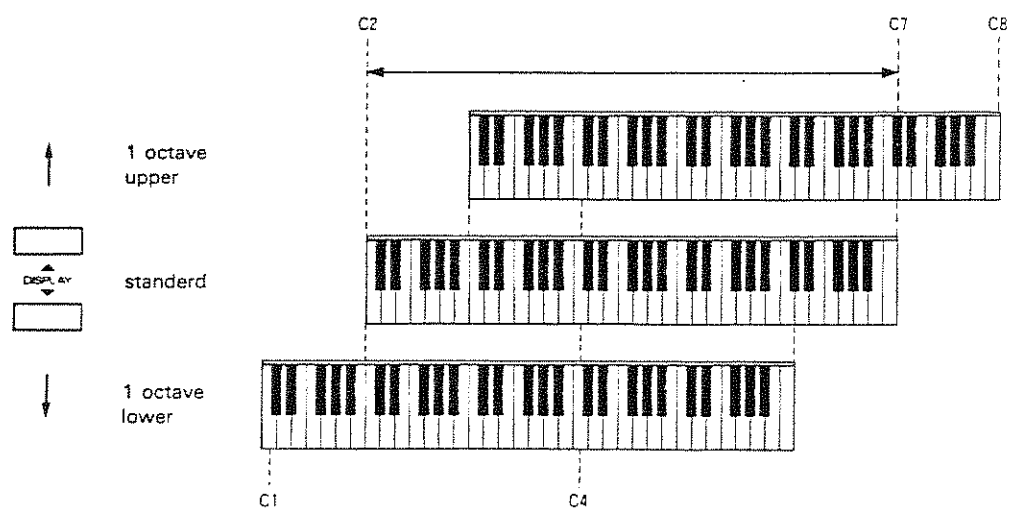

*If you wish the timing to be exact, take the Quantize procedure. (See page 26.)

*If you wish to correct the rhythm pattern you have made, erase it. (See page 28.)

*The maximum number of voices played simultaneously is 8, so the 9th note will be ignored.

*When an Internal Tone is used as a rhythm tone for playing with rhythm patterns, the ENV mode (see page 124) of the Tone is automatically set to NO SUSTAIN (therefore it may sound different).

- Step 10** To write the rhythm pattern you have made, first, stop the rhythm by pressing the STOP button, then take the appropriate writing procedure (page 32).

*If you do not want to write the rhythm pattern you have made, push the EXIT button.

[Quantize]

The Quantize function corrects the timing of the rhythm pattern so that it will become as accurate as a score. This is achieved by setting the number of steps which can be entered in a rhythm pattern. Quantizing can be done during the rhythm pattern editing mode, therefore it is possible to set a different value (the shortest note) for each Rhythm Tone. Quantizing can be set in the Step 6's Display even while a rhythm is running.

Step 1 Push the **Cursor Button** on the left.

The Quantize value flashes in the Display.

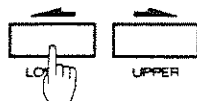
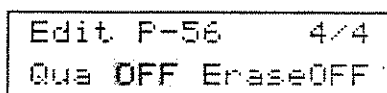

Step 2 Using the **Value Control Knob** select the timing value you like.

OFF : No correction

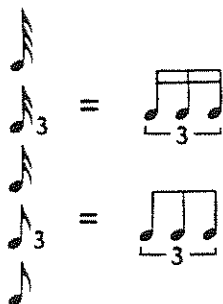

Depending on the time signature, the number of steps will vary.

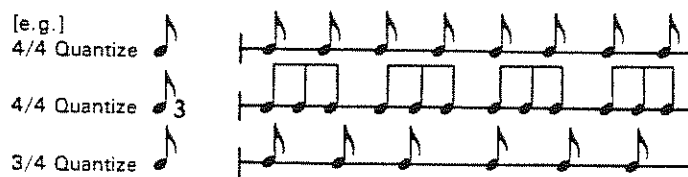

*To change the tempo during the quantizing procedure, move the Value Control Knob while holding the TEMPO button down.

- Step 3 Tap the key on the keyboard.
The rhythm will be played with the timing automatically corrected.
- Step 4 To enter a different value for quantization, repeat Step 2 and Step 3.
- Step 5 To return to the previous mode allows you to change the tempo with the Value Control Knob, push the Cursor Button on the left. (The flashing will stop.)

[Erase]

The Erase function is useful for correcting any mistakes you have made in a rhythm pattern. The Rhythm Tone used for the rhythm pattern is erased, and therefore new data can be entered. The Erase function can be set in the Step 6's Display even while a rhythm is being played.

Step 1 Push the Cursor Button on the right.

The Erase value flashes in the Display.

```

Edit P-56    4/4
Qus OFF EraseOFF
  
```

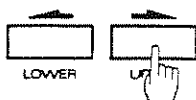

Step 2 Select "ON" with the Value Control Knob.

Step 3 Press the key where the Rhythm Tone to be erased is assigned.

Holding the key down will continue to erase the relevant Rhythm Tone.

Step 4 Return to "Erase OFF" with the Value Control Knob.

Step 5 Play the keyboard to correct the mistake.

Step 6 Push the Cursor Button on the right, and "Erase" will stop flashing, and the Display will return to the previous condition which allows you to change the tempo with the Value Control Knob.

2) Editing Procedure (II)

This is making a rhythm pattern using the performance data of a MIDI device such as a rhythm machine.

*The rhythm pattern you have made will be erased when a different rhythm pattern is selected or the unit is turned off. To retain the edited data, take the appropriate writing procedure as shown on page 32 "Writing Procedure".

[Preparation]

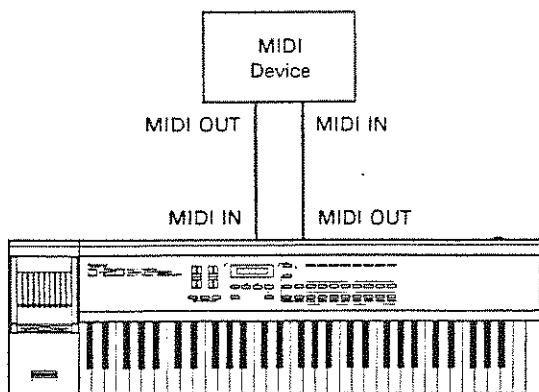

① Set the MIDI channels of the D-20's Rhythm section and the external device to the same number.

*In the Performance mode, see page 157 "MIDI Function Setting", and in the Multi Timbral mode, see page 9 "MIDI Function Setting".

② Match the Key Number-Rhythm Tone assignment of the external device to the D-20's Rhythm section.

*The Key Number-Rhythm Tone assignment of the D-20's Rhythm section is shown on page 80 "Rhythm Setup".

③ Set the Sync mode of the external device so that it can receive the sync signal from the D-20.

[Procedure]

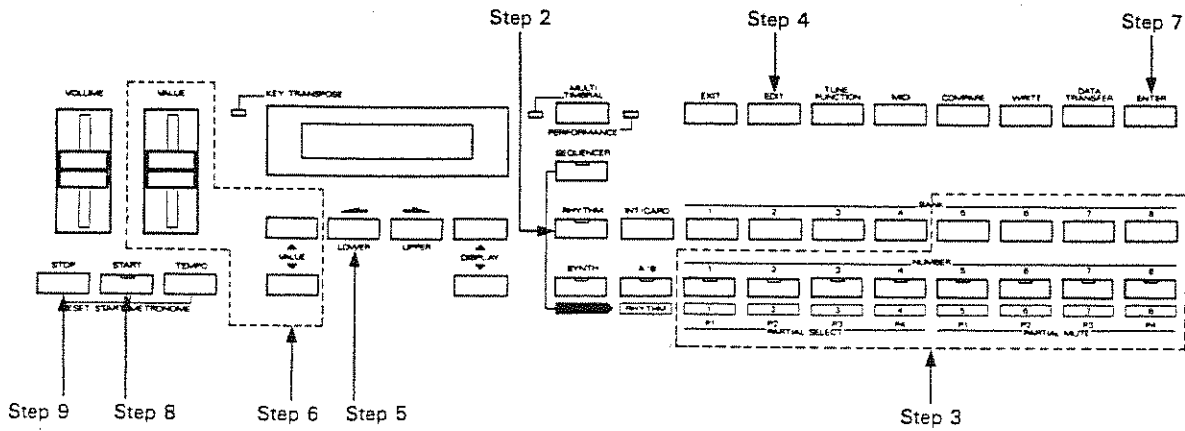

Step 1 Stand by the external device to the rhythm pattern play mode.

Step 2 Push the RHYTHM button on the D-20.(The indicator lights up.)

```

Pattern Play
P-56:UserPattern
    
```

Step 3 Using the BANK and NUMBER buttons, select a rhythm pattern (destination pattern number), from P-51 to P-88, which is to be replaced with the new data.

Step 4 Push the EDIT button.

```

Edit P-56 Clear?
Yes      No
    
```

Step 5 Push the Cursor Button on the left to clear the entire data of the selected rhythm pattern.

Step 6 Using the Value Control Knob, set the time signature value (1/4 to 8/4) of the rhythm pattern.

```

Edit P-56
Time 4/4 Enter
    
```

Step 7 Push the ENTER button.

Edit P-56	4/4
Qwa OFF	EraseOFF

Step 8 Push the START button.

*The maximum number of notes which can be entered simultaneously is 8, so the 9th note will be ignored.

*The maximum number of notes which can be entered into rhythm patterns is 96.

Step 9 Push the STOP button to stop the rhythm, then take the appropriate writing procedure shown in the following section.

*If you do not wish to write the rhythm pattern you have made, push the EXIT button.

3) Writing Procedure

If you wish to retain the rhythm patterns you have programmed, write it into the internal memory (P51 to P88), erasing the existing data in memory or save it onto an optional memory card (M-256D, M-256E).

[Writing into the internal memory]

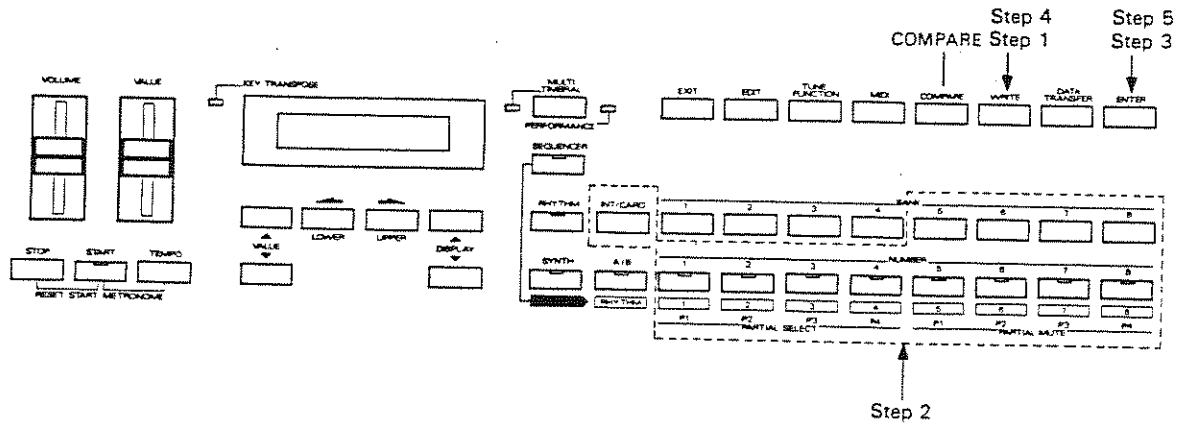

Step 1 Push the WRITE button.

"I" is shown when the Internal memory is selected,
and "C" is shown when Memory card is Selected.

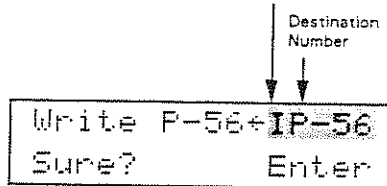

*When a Preset Rhythm Pattern (P11 to 48) has been edited, the destination Pattern Number is not shown in the Display.

Step 2 To change the destination Pattern Number, use the BANK (5 to 8) and NUMBER buttons.

If you wish to listen to the destination Rhythm Pattern before rewriting it, do as follows.

① Push the COMPARE button.

```
Compare to IP-36
```

② Select a destination Pattern Number using the BANK (5 to 8) and NUMBER buttons.

③ Push the START button to listen to the rhythm pattern.

④ Push the STOP button to stop playing.

⑤ Push the COMPARE button to return to the original Display.

Step 3 Push the ENTER button.

```
Turn Protect off
once? Write/Exit
```

Step 4 Push the WRITE button.

The Memory Protect function is released and the Step 2's Display is recalled.

Step 5 Push the ENTER button.

When the writing is completed, the following Display is shown for a while, then returns to the Pattern Play Display.

```
Complete
```

*If the writing is not properly done, an error message will be shown. Resolve it as instructed on page 212 "Error Messages".

[Writing onto a Memory Card]

*When you use a brand new memory card, first save the entire data in the internal memory onto the memory card as shown on page 189 "Saving", then take the writing procedure.

*The Rhythm Patterns saved on a memory card cannot be used unless copied into the internal memory, and therefore will be securely preserved.

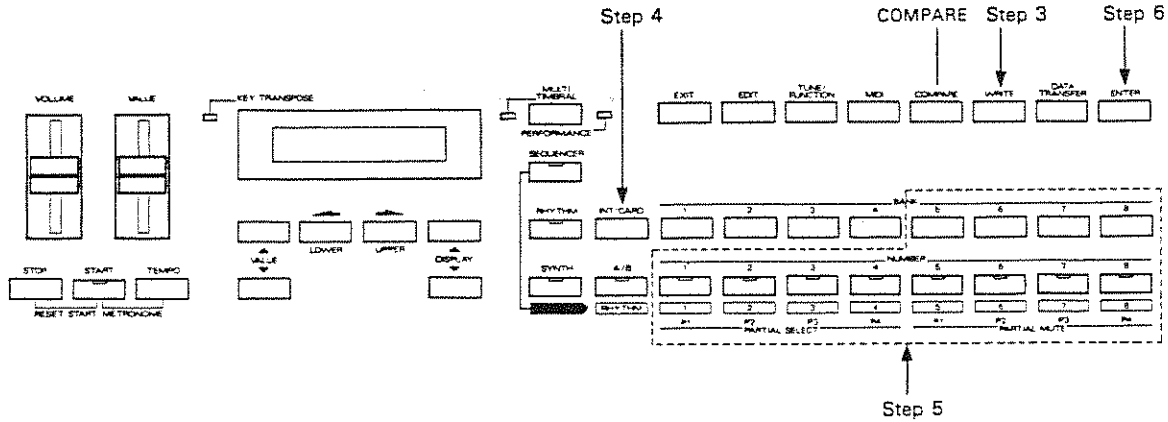

- Step 1 Insert a memory card into the Card Slot.
- Step 2 Set the Protect Switch on the memory card to the OFF position.
- Step 3 Push the WRITE button.

"I" is shown when the Internal memory is selected, and "C" is shown when Memory card is Selected.

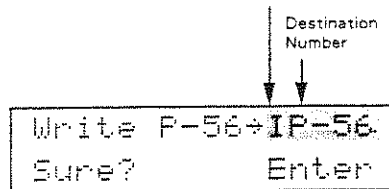

*When a Preset Rhythm Pattern (P11 to P48) has been edited, the destination Pattern Number is not shown in the Display.

- Step 4 Select "C" by pushing the INT/CARD button.

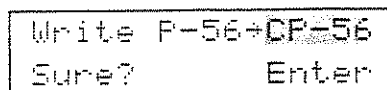

Step 5 To change the destination Pattern Number, use the BANK (5 to 8) and NUMBER buttons.

If you wish to listen to the destination Rhythm Pattern before rewriting it, do as follows.

① Push the COMPARE button.

Compare to CP-56

② Select a destination Pattern Number using the BANK (5 to 8) and NUMBER buttons.

③ Push the START button to listen to the rhythm pattern.

④ Push the STOP button to stop playing.

⑤ Push the COMPARE button to return to the original Display.

Step 6 Push the ENTER button.

When the writing is completed, the following Display is shown for a while, then returns to the Pattern Play Display.

Complete

*If the writing is not properly done, an error message will be shown. Resolve it as instructed on page 212 "Error Messages".

Step 7 Return the Protect Switch on the memory card to the ON position.

2. Recording

The following explains Track recording.

a. Basic Procedure

1) Sequencer Mode

The Sequencer mode switches the D-20 to a MIDI sequencer, which allows Track recording.

Pushing the SEQUENCER button will select the Sequencer mode. (The indicator lights up.)

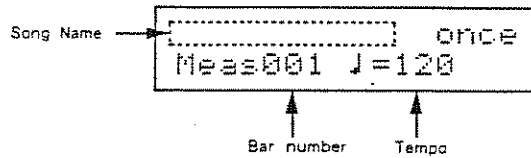

*At this stage, Tracks do not have Song Names. If you wish to use a Song name, see page 76 "Song Name".

[Sequencer Mode]

In the Sequencer mode, the buttons and knobs on the control panel function as shown below.

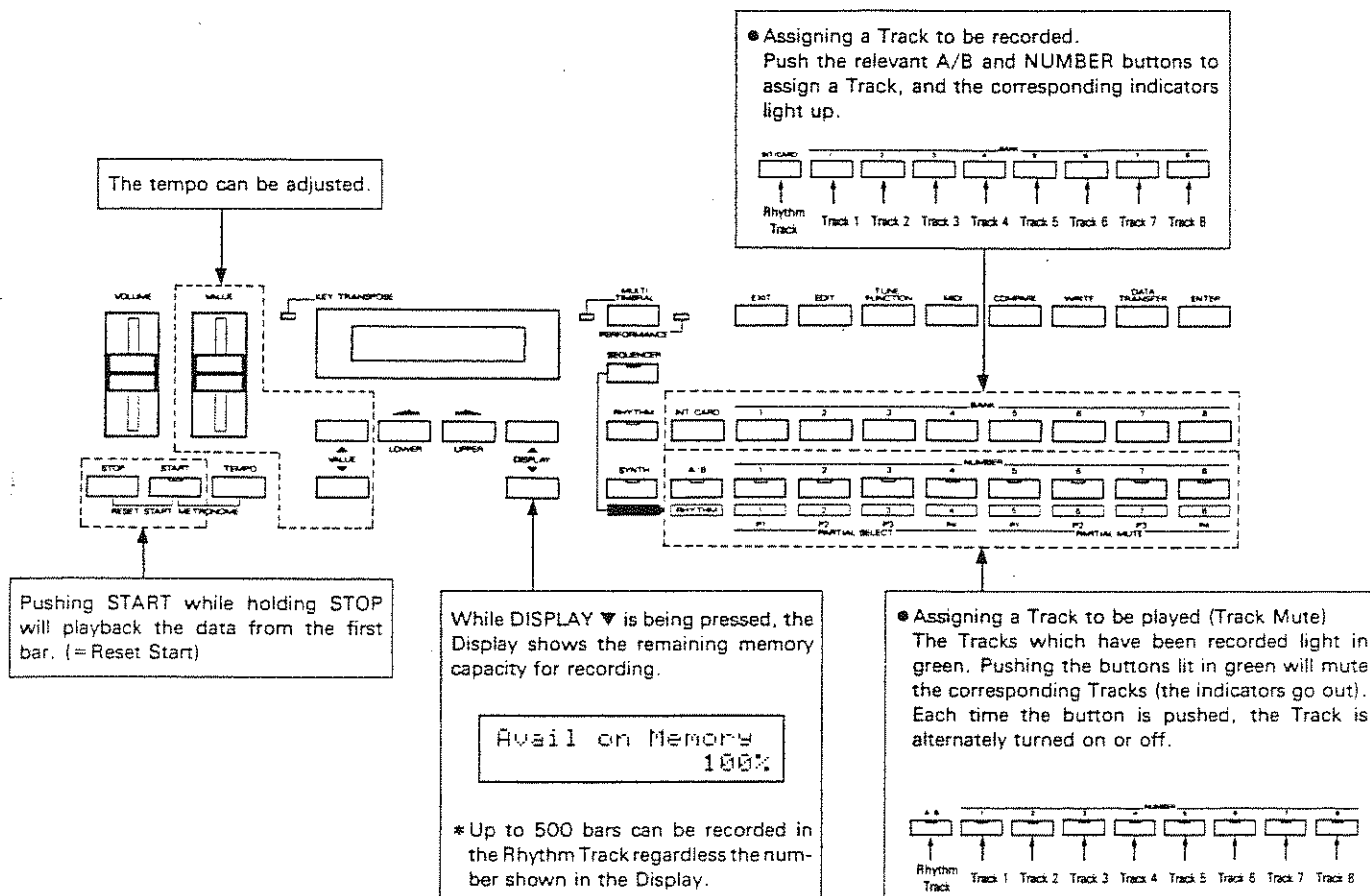

[Recording Mode]

Assigning a Track to be programmed by pushing the INT/CARD and BANK buttons will make the Sequencer unit ready for Track Recording. This is called Recording Mode. In the Recording Mode, the control panel functions as shown below.

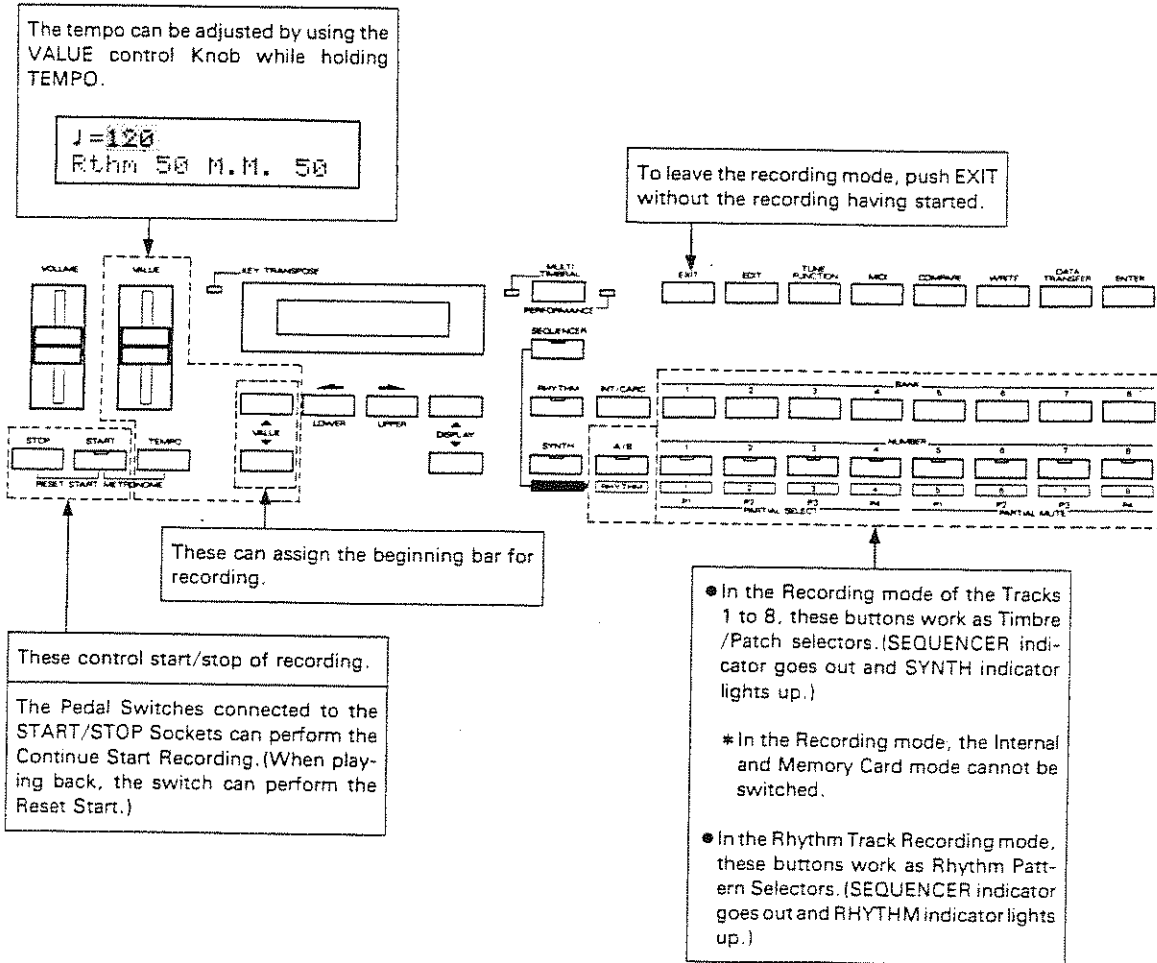

2) Rhythm Track

Pushing the INT/CARD button will turn the Sequencer unit to the Rhythm Track Recording mode. (The indicator of the A/B button flashes in red.)

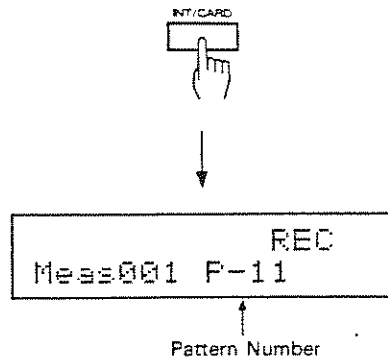

There are two methods for rhythm track recording: one is playing rhythm patterns in sequence (Recording 1), and the other is assigning a rhythm pattern to each bar (Recording 2).

*Recording rhythm data in a rhythm track will automatically rewrite any previous data. However, if you wish to erase the entire existing data, or a bar of data, use the "Erase" procedure explained on page 44.

*Note that if you rewrite a rhythm pattern in the Rhythm Track with a rhythm pattern of a different beat after programming Tracks 1 to 8, the rhythm performance will be incorrect.

[Recording 1]

This method programs a rhythm track by playing rhythm patterns in sequence, and therefore, is quicker than Recording 2.

<Recording from the first bar>

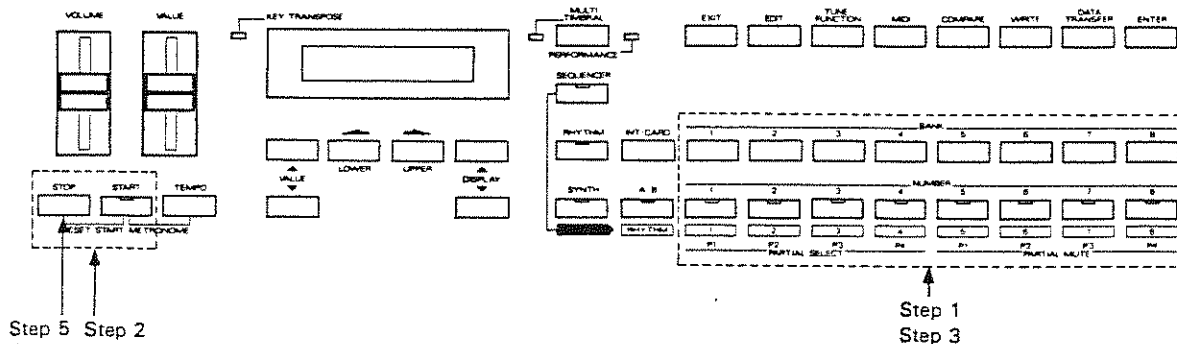

Step 1 Select a rhythm pattern for the first bar using the BANK and NUMBER buttons. (If you want the pattern number shown in the Display for the first bar, skip this step.)

When a rhythm pattern is selected, the number flashes.

*The bar number shown in the Display is irrelevant.

Step 2 While holding the STOP button down, press the START button. (The indicator of the A/B button stops flashing and lights steadily.)

The Display shows bar number 001.

Step 3 While the rhythm pattern of the first bar is being played, assign a rhythm pattern for the second bar.

*If you want the same rhythm pattern for the second bar, skip Step 3.

Step 4 Repeat Step 3 for the following bars.

Step 5 When you finish the rhythm track recording, push the STOP button.

The indicator of the A/B button changes from red to green, and the unit returned to the Sequencer Mode.

<Recording from any bar>

It is possible to start recording from any bar you like.

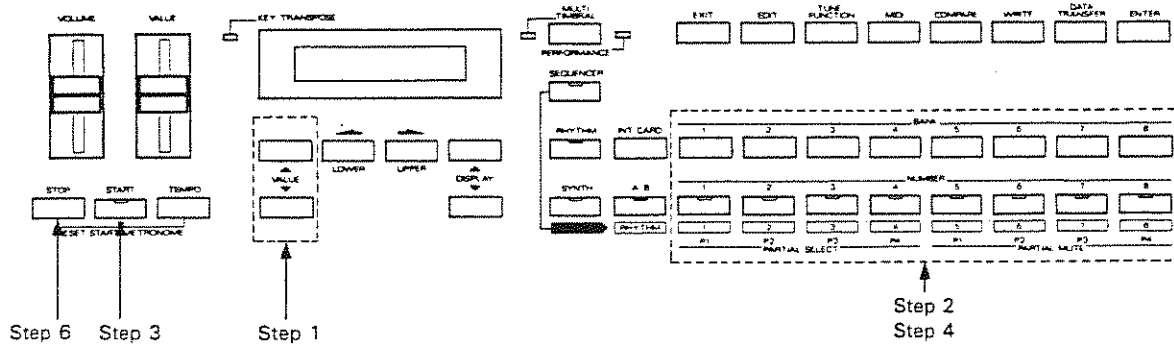

Step 1 Select the bar where you wish to start recording with the VALUE Buttons.

Step 2 Select a rhythm pattern to be assigned to the bar using the BANK and NUMBER buttons. (If you want to assign the pattern number shown in the Display, skip this step.)

When the rhythm pattern is selected, the number flashes.

Step 3 Press the START button.

The rhythm pattern you have selected will be played.

Step 4 To select a different rhythm pattern for the next bar, assign it while the rhythm is still playing, using the BANK and NUMBER buttons.

*If you want the same rhythm pattern for the next bar, skip Step 4.

Step 5 Repeat Step 4 for the following bars.

Step 6 When you finish the rhythm track recording, push the STOP button.

The indicator of the A/B from red to green, and the unit is returned to the Sequencer Mode.

[Recording 2]

This method is achieved by assigning a rhythm pattern to each bar in sequence.

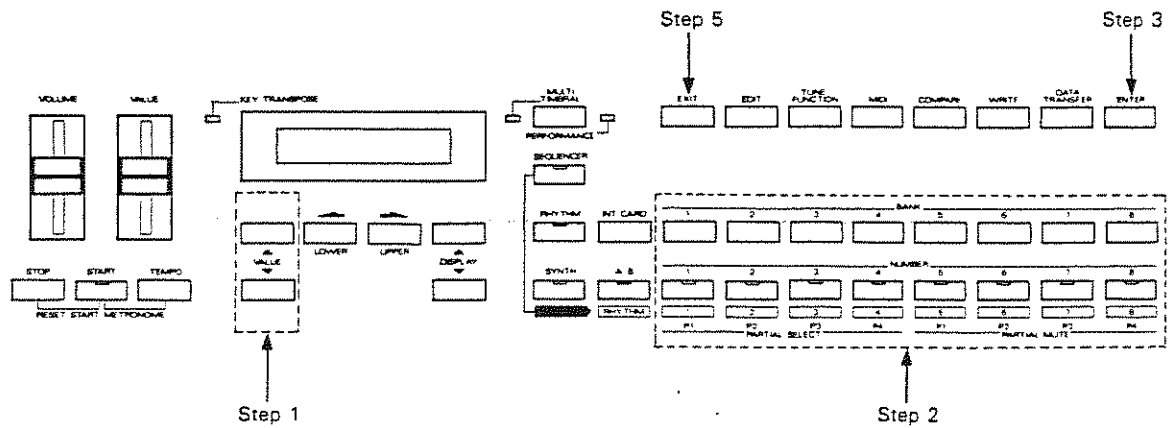

Step 1 Select the bar where you wish to start recording with the VALUE buttons.

Step 2 Select a rhythm pattern to be assigned to the bar using the BANK and NUMBER buttons. (If you want to assign the pattern number shown in the Display, skip this step.)

When the rhythm pattern is selected, the number flashes.

Step 3 Push the ENTER button.

The selected rhythm pattern is recorded, and the bar number is advanced.

Step 4 Repeat Steps 2 and 3 as many times as necessary for the following bars.

Step 5 When you finish the rhythm track recording, push the EXIT button.

The indicator of the A/B changes from red to green, and the unit is returned to the Sequencer Mode.

[Erase]

The Erase function allows you to erase rhythm track data from any bar you assign to the end. If you wish to use this function, do as follows in the Recording mode.

*If you erase bars of performance data in the Rhythm Track after recording Tracks 1 to 8, the bars that corresponding bars in the other Tracks will not play. If this happens, record the erased bars again in any of the Tracks.

Step 1 Push either of the DISPLAY buttons.



```

TrackErase Sure?
Meas010      Enter
  
```

Step 2 Select the bar from which you wish to erase with VALUE buttons.

Step 3 Push the ENTER button.

When the data is erased, the Display responds as below for a while, then returns to the previous Display (=before the above procedure was performed).

```

Complete
  
```

3) Tracks 1 to 7

Tracks 1 to 7 can be recorded similarly.

There are two methods for recording Tracks 1 to 7, one is recording after a metronome count-in (=Count-in Recording), and the other is recording in the same timing as playing the keys.

[Count-in Recording]

Two bars of a metronome count in are played before recording actually begins.

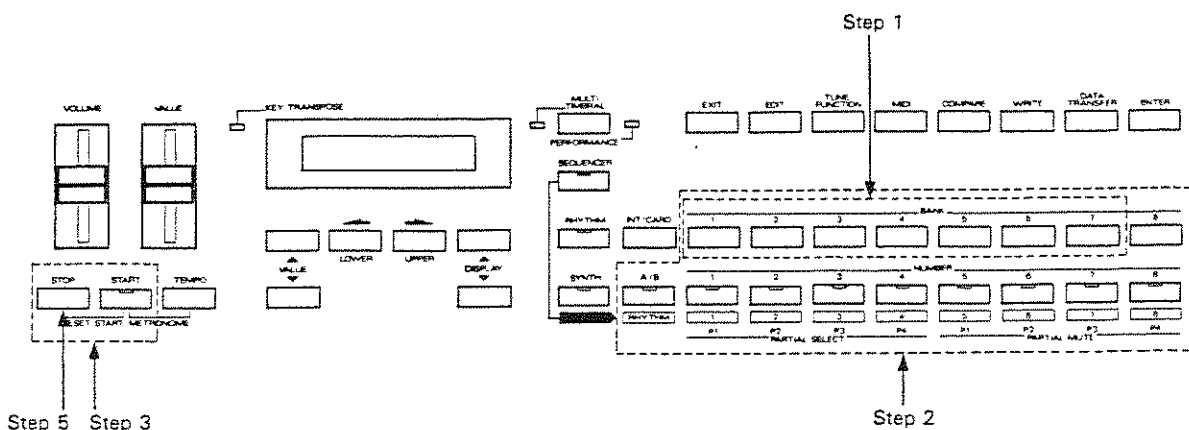

Step 1

Select a Track to be recorded with the corresponding BANK buttons 1 to 7.

The corresponding NUMBER indicator flashes in red, and the Display shows as below.

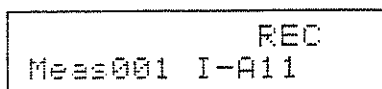

Timbre/Patch number

The SEQUENCER Indicator goes out and the SYNTH Indicator lights up. The A/B, BANK and NUMBER buttons work as Timbre/Patch selection buttons.

*In the Display the Timbre/Patch Number is shown only when the bar number is 001.

Step 2 Select a Timbre or Patch using the A/B, BANK and NUMBER buttons.

*A Timbre or Patch cannot be selected until the NUMBER button is pressed. If the Number is not yet assigned, the number flashes and the Timbre or Patch currently assigned to the Part will be selected instead.

Step 3 Push the START button while holding the STOP button.

● Count-in
The bar number in the Display counts down like -2, -1...

```
Count  
Meas -2 I-A11
```



● Recording
The NUMBER indicators stop flashing and light steadily, then recording start.

```
REC  
Meas001 I-A11
```

Step 4 Play the keyboard.

*Even if you start playing the keyboard before the two bar count-in is completed, only the information after the count-in will be recorded.

Step 5 When you have finished, push the STOP button.

The NUMBER indicator changes from red to green and the unit is returned to the Sequencer mode.

Step 6 Similarly, continue recording the other Tracks.

[Key On Recording]

Key On recording starts recording the moment you start playing the keyboard.

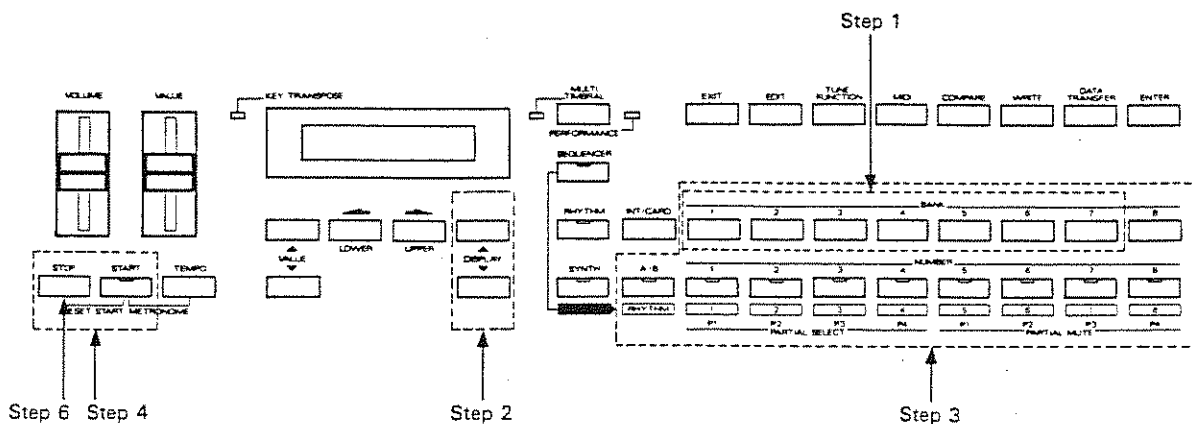

Step 1 Select a Track to be recorded with the corresponding BANK buttons 1 to 7.

The corresponding NUMBER indicator flashes in red, and the Display shows as below.

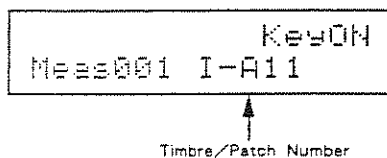

The SEQUENCER indicator goes out and the SYNTH indicator lights up. The A/B, BANK and NUMBER buttons work as Timbre/Patch selection buttons.

*In the Display the Timbre/Patch Number is shown only when the bar number is 001.

Step 2 Select the following Display with the DISPLAY buttons.

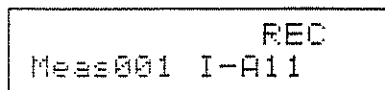

Step 3 Select a Timbre or Patch using the A/B, BANK and NUMBER buttons.

*A Timbre or Patch cannot be selected until the NUMBER button is pressed. If the Number is not yet assigned, the number flashes and the Timbre or Patch currently assigned to the Part will be selected instead.

- Step 4** **Push the START button while holding the STOP button.**
- Bar number 001 is shown in the Display, and the metronome will play in the tempo currently set.
- Step 5** **Play the keyboard.**
- *As soon as you start playing the keyboard, recording will begin. (The NUMBER indicator stops flashing and remains alight.)
- Step 6** **When you have finished, push the STOP button.**
- The NUMBER indicator changes from red to green and the unit is returned to the Sequencer mode.
- Step 7** **Similarly, continue recording the other Tracks.**

4) Track 8

In case of first recording into Track 8, this Track can be used either for recording a Synth Part like Tracks 1 to 7, or for recording rhythm performance in real time.

【Synth Part Recording】

Step 1 Push the BANK 8 button.

The NUMBER 8 indicator flashes in red, and the Display responds with :



Track 8 Select
Part8 Rhythm

Step 2 Push the left Cursor Button.

Track 8 Select
Part8 Rhythm

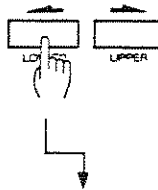

REC
Meas001 I-A11

Then, take exactly the same procedure as in recording Tracks 1 to 7.

[Rhythm Recording]

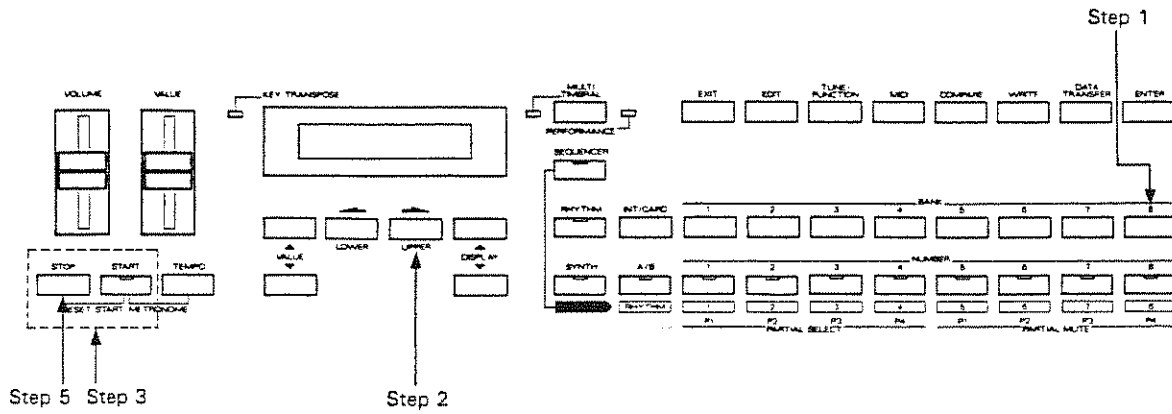

Step 1 Push the BANK 8 button.

The NUMBER 8 indicator flashes in red, and the Display responds with:

```

Track 8 Select
Part8 Rhythm
    
```

Step 2 Push the right Cursor Button.

```

REC
Mess001 Rhythm
    
```

The SEQUENCER indicator goes out, and the RHYTHM indicator lights up. Rhythm Tones are now assigned to keys on the keyboard.

If you wish to do Key On Recording, call the following display.

```

KeyON
Mess001 Rhythm
    
```

Step 3 Push the START button while holding the STOP button.

When Count In Recording is done, the recording will start after the bar number in the Display counts down like -2 -1.....

When Key On Recording is done, the recording will start at the same time that you start playing the keyboard.

*To record Rhythm Tones which exceed the keyboard range, transpose the keyboard range using the DISPLAY buttons.

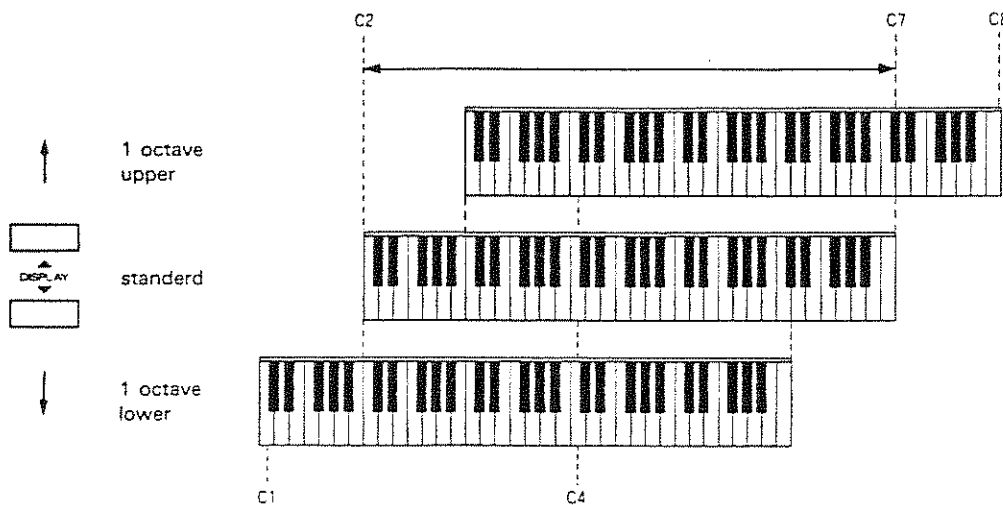

*The Key--Rhythm Tone assignment preprogrammed by the manufacturer is shown on page 84.

Step 4 Play the key that corresponds to the Rhythm Tone to be assigned. How you play the keyboard will control the velocity.

*Even if you start playing the keyboard before the two bar count-in is completed, only the information after the count-in will be recorded.

Step 5 . . . When you have finished, push the STOP button.

The NUMBER indicator changes from red to green and the unit is returned to the Sequencer mode.

b. Editing Performance Data

1) Recording from any bar

The D-20 allows you to re-record from any bar you like.

[Count-in Recording]

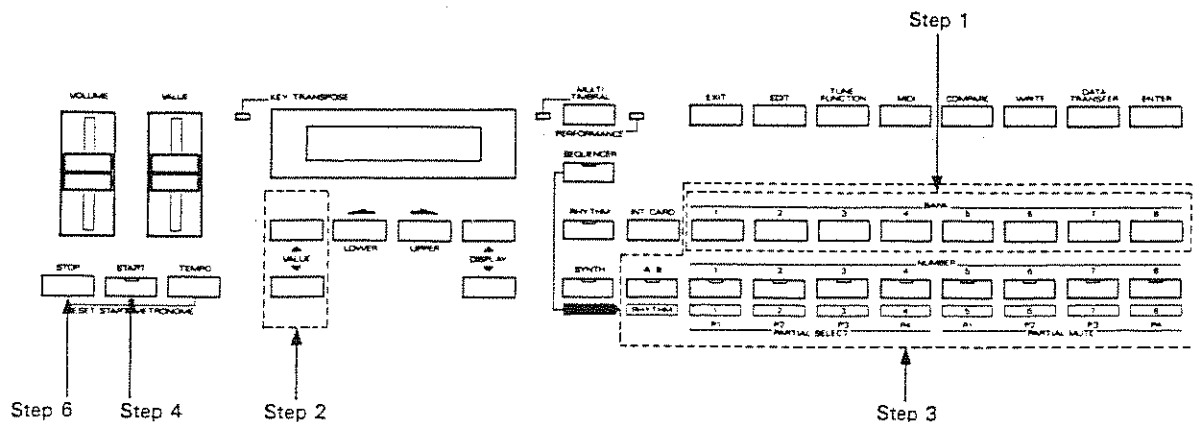

Step 1 Select a Track to be re-recorded with the relevant BANK button.

The corresponding NUMBER indicator will flash in red.

*Since the performance data for keyboard is played using the Timbre/Patch and Pan/Volume setting selected previously, the correct performance is recorded faithfully.

Step 2 Assign a bar with the VALUE button.

Step 3 If you wish to change the Timbre or Patch at the re-recording position, select a new Patch or Timbre with the A/B, BANK and NUMBER buttons.

A Timbre or Patch cannot be selected unless the Number is assigned. If you fail to assign a Number, the number will flash and the Timbre or Patch is not recorded.

Step 4 Push the START button.

● Count-in

Two bars of count-in is heard from two bars before the assigned bar number. During the Count-in, data is being played.

```
Count.  
Meas031 I-A11
```



● Recording

NUMBER Indicators stop flashing and light Steadily, and recording starts from the assigned bar.

```
REC  
Meas033 I-A11
```

Step 5 Play the keyboard.

Step 6 When finished recording, push the STOP button.

The NUMBER indicator changes from red to green, and the unit is returned to the Sequencer mode.

[Key On Recording]

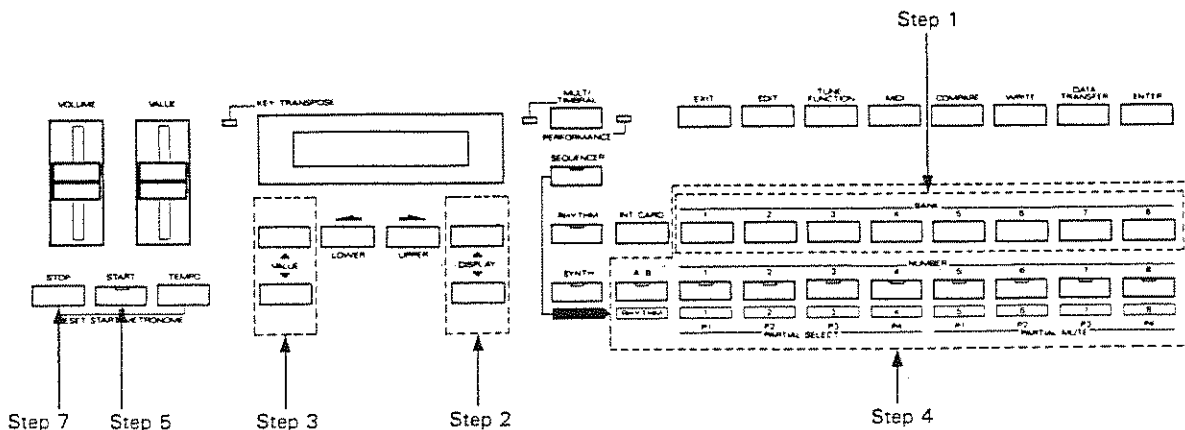

- Step 1 Select a Track to be re-recorded with the relevant BANK button.
The corresponding NUMBER indicator will glow (red).
- Step 2 Using the DISPLAY buttons, call the following display.

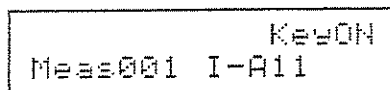

Timbre/Patch Number

- Step 3 Assign a bar with the VALUE button.

*Since the performance data for keyboard is played using the Timbre/Patch and Pan/Volume setting selected previously, the current performance is recorded faithfully.
- Step 4 If you wish to change the Timbre or Patch at the re-recording position, select a new Patch or Timbre with the A/B, BANK and NUMBER buttons.

A Timbre or Patch cannot be selected unless the Number is assigned. If you fail to assign a Number, the number will flash and the Timbre or Patch is not recorded.
- Step 5 Push the START button.

The metronome will play at the tempo currently set.

Step 6 **Play the keyboard.**

Playing the keyboard will automatically start recording. (The NUMBER indicator stops flashing, remaining alight.)

Step 7 **When finished recording, push the STOP button.**

The NUMBER indicator changes from red to green, and the unit is returned to the Sequencer mode.

2) Punch In/Punch Out

The Punch In/Punch Out function allows you to re-record a part of the data while listening to the recorded performance data. Starting to re-record is called Punch In, and leaving re-recording is called Punch Out. You can use this function repeatedly. The Punch In/Punch Out function is usually performed with a Pedal Switch (DP-2 or DP-6), and it is also available with the panel operation.

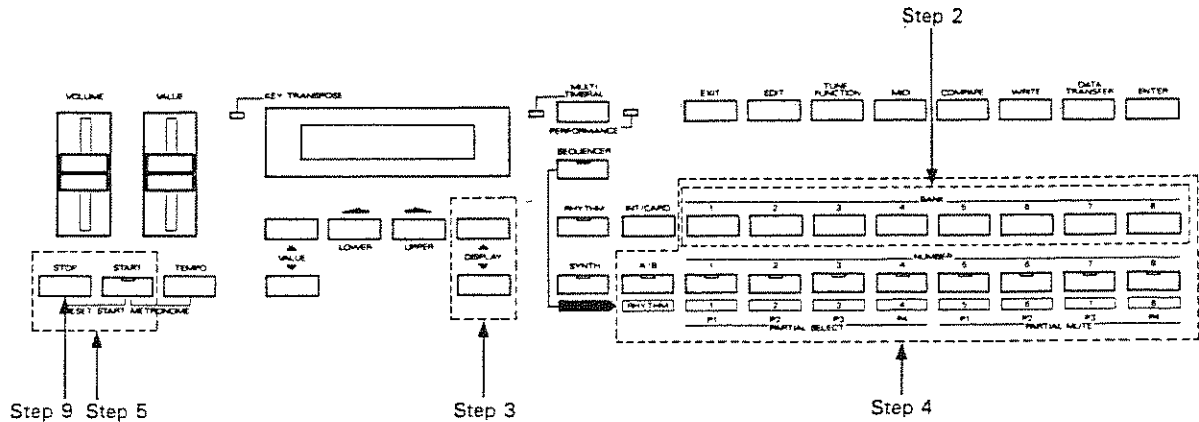

Step 1

Connect the Pedal Switches to the Punch In/Out Sockets on the rear panel.

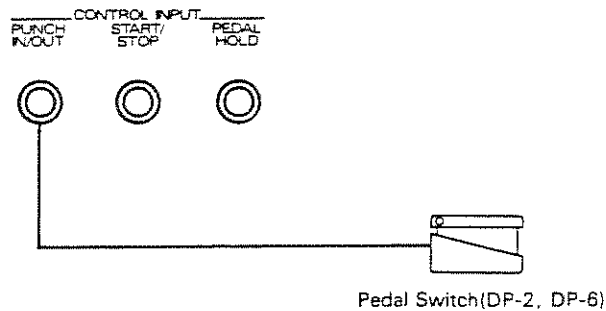

Step 2

Select a Track to be re-recorded with the relevant BANK button.

The corresponding NUMBER indicator will light (red).

Step 3

Using the DISPLAY buttons, call the following display.

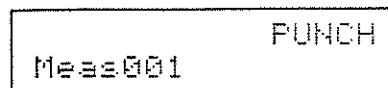

- Step 4 If you wish to change the Timbre or Patch at the re-recording position, select a new Patch or Timbre with the A/B, BANK and NUMBER buttons.

The selected Timber or Patch number will show the each number of them.

```

          PUNCH
Meas001 I-B33
  
```

- Step 5 Push the START button while holding the STOP down.

After the count-in metronome, the Track is played back.

```

          PUNCH
Meas001 I-B33
  
```

- Step 6 Play the keyboard, and press the pedal at the Punch-in position.

```

          P-IN
Meas100 I-B33
  
```

*The Punch In/Punch Out function is also performed with the ENTER button. Each time this button is pressed, the alternately functions the Punch In or the Punch Out.

- Step 7 Keep playing the keyboard, and press the pedal at the Punch-out position.

```

          P-OUT
Meas123 I-B33
  
```

- Step 8 If you wish to continue to correct data, repeat Steps 6 and 7.

- Step 9 When finished correcting data, push the STOP button.

The NUMBER indicator changes from red to green, and the unit is returned to the Sequencer mode.

3) Overdubbing

Overdubbing is recording data on existing tracks. This function is useful for adding more performance data within a Track. The Overdub function allows to record the Control messages such as Pan and Volume.

There are two methods for overdubbing, Count In Overdubbing and Key On Overdubbing. (Another different method is used for overdubbing Control messages such as Pan and Volume.)

*If you do not like the overdubbed data, you can erase it.

[Count-in Overdubbing]

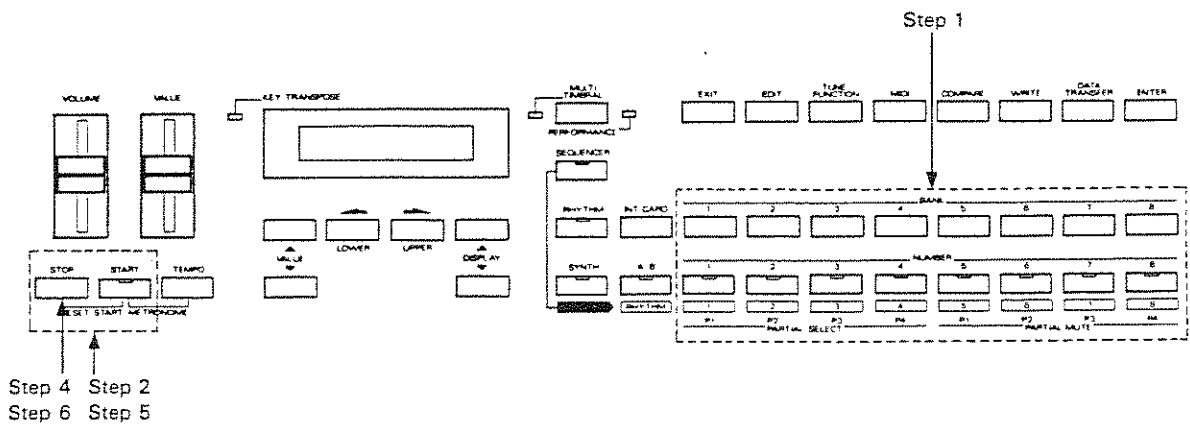

Step 1

While holding the BANK button down (the one that corresponds to the Track to be overdubbed), push the NUMBER button of the Track.

The NUMBER indicator flashes (orange), then the Display responds with :

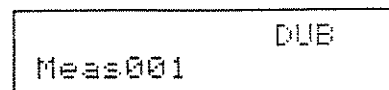

Step 2 Push the START button while holding the STOP button down.

After the metronome count-in, overdubbing starts. (The NUMBER indicator stops flashing and remains alight.)

Step 3 Play the keyboard.

Step 4 When completed, push the STOP button.

The NUMBER indicator turns to green. At this stage, the overdub is not yet complete.

```
          Sure?  
Meas051 I-A11
```

Step 5 While holding the STOP button down, push the START button to monitor the performance data you have played.

Step 6 Push the STOP button.

Step 7 Now, you can either execute the overdub or retrieve the previous data.

If you wish to execute the overdub, push the ENTER button.

The Display is shown as below, then returns to the previous display.

```
Complete
```

If you wish to retrieve the previous performance data, push the EXIT button.

The Display is shown as below, then returns to the previous display.

```
Cancel
```

[Key-on Overdubbing]

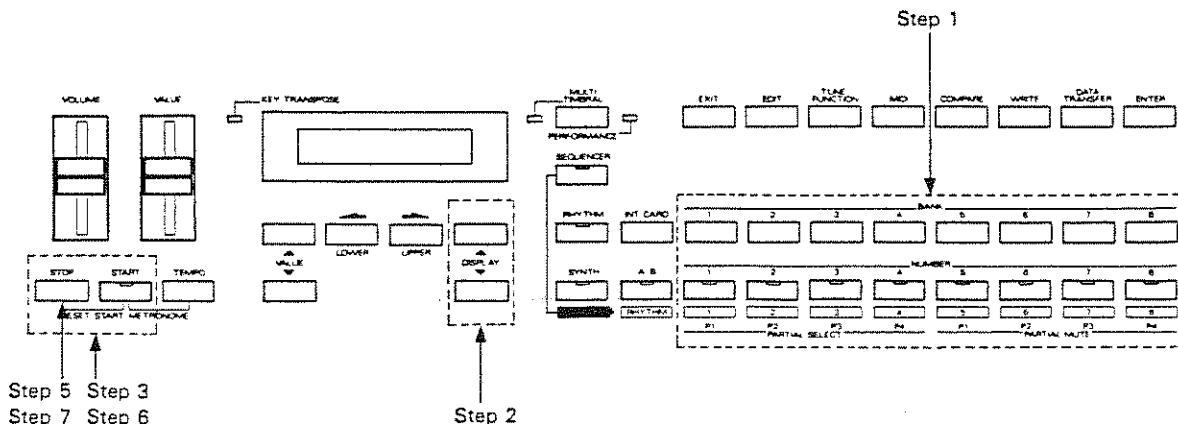

Step 1 While holding the **BANK** button down (the one that corresponds to the Track to be overdubbed), push the **NUMBER** button of the Track.

The **NUMBER** indicator flashes (orange), then the Display responds with :

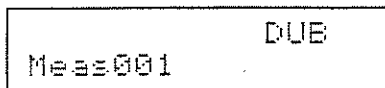

Step 2 Using the **DISPLAY** button, call the following Display.

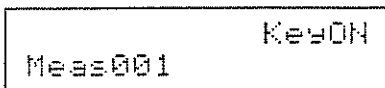

Step 3 Push the **START** button while holding the **STOP** button down.

Bar number 001 is shown in the Display, and the metronome will play in the tempo currently set.

Step 4 Play the keyboard.

Playing the keyboard will automatically start recording. (The **NUMBER** indicator stops flashing and remains alight.)

Step 5 When finished overdubbing, push the STOP button.

The NUMBER indicator turns to green. At this stage, the overdub is not yet complete.

```
          Sure?  
Meas051 I-A11
```

Step 6 While holding the STOP button down, push the START button to monitor the performance data you have played.

Step 7 Push the STOP button.

Step 8 Now, you can either execute the overdub or retrieve the previous data.

If you wish to execute the overdub, push the ENTER button.

The Display changes as shown below, then returns to the previous display.

```
Complete
```

If you wish to retrieve the previous performance data, push the EXIT button.

The Display is shown as below, then returns to the previous display.

```
Cancel
```

[Overdubbing of Pan/Volume]

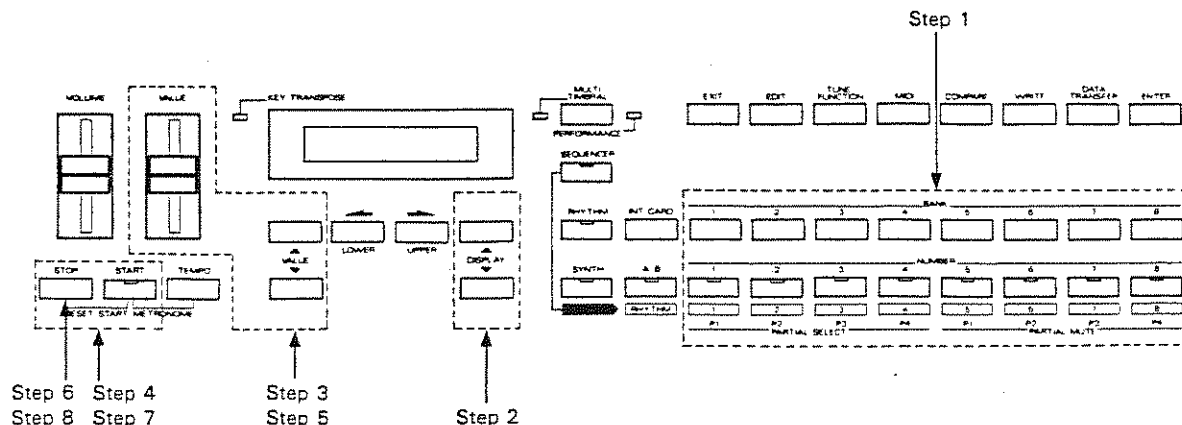

Step 1 While holding the **BANK** button down (the one that corresponds to the Track to be overdubbed), push the **NUMBER** button of the Track. The **NUMBER** indicator flashes (orange), then the Display responds with:

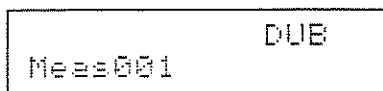

Step 2 Using the **DISPLAY** button, call the following Display.

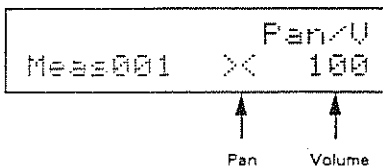

Step 3 Set the initial values of the Pan and Volume.
 ○The Value Control Knob changes the value for the Volume from 0 to 100. Higher values increase the volume.

○The keyboard changes the value for the Pan as shown below.

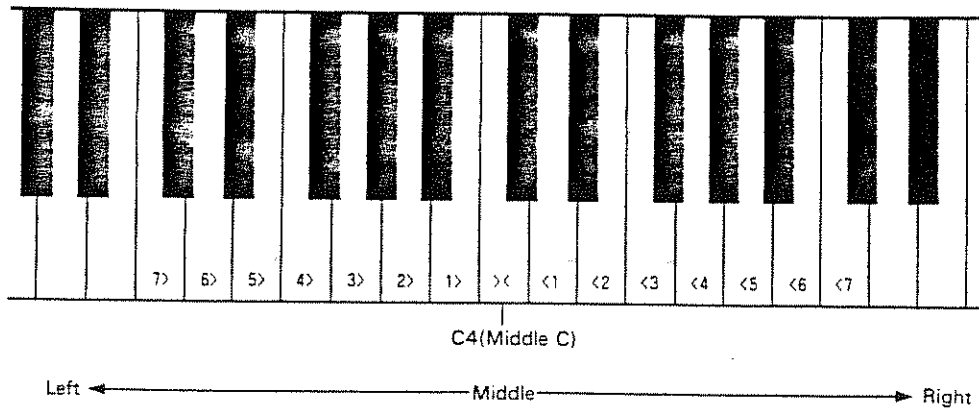

*If a rhythm performance has been recorded in Track 8, Pan Overdubbing cannot be done in track 8.

Step 4 Push the START button while holding the STOP button down.

After the metronome count-in, overdubbing starts. (The NUMBER indicator stops flashing and remains alight.)

Step 5 Using the Value Control Knob and the keyboard, change the values of the Pan and Volume you have set.

Step 6 When finished overdubbing, push the STOP button.

The NUMBER indicator turns to green. At this stage, the overdub is not yet complete.

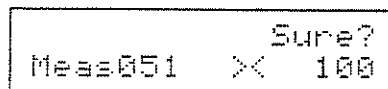

Step 7 While holding the STOP button down, push the START button to monitor the performance data you have played.

Step 8 Push the STOP button and stop playing the keyboard.

Step 9

Now, you can either execute the overdub or retrieve the previous data.

○ If you wish to execute the overdub, push the ENTER button.

The Display is shown as below, then returns to the previous display.

Complete

○ If you wish to retrieve the previous performance data, push the EXIT button.

The Display is shown as below, then returns to the previous display.

Cancel

4) Clear

The D-20 allows you to clear the entire performance data you have recorded (=All Clear) or the data in each Track (=Track Clear).

[ALL Clear]

The All Clear function can erase the performance data recorded in all the Tracks (including the Rhythm Track).

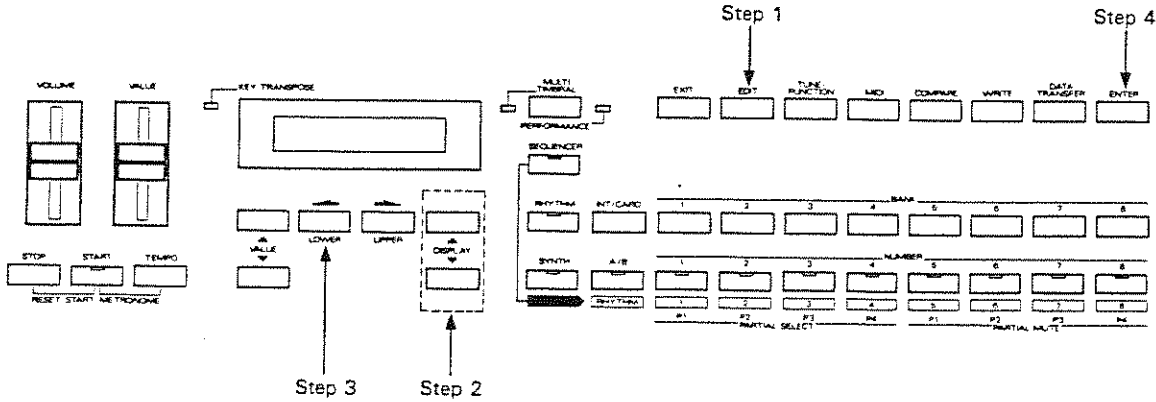

Step 1 Push the EDIT button.

```
Quantize Select
  [Cursor] Enter
```

Step 2 Call the following Display using the DISPLAY buttons.

```
Clear Select
All Track
```

Step 3 Push the left Cursor Button.

```
Clear All Sure?
  Enter
```

Step 4 Push the ENTER button.

When data is cleared, the following Display is shown for a while then returned to the previous Display.

```
Complete
```

<Beat Setting>

After the All Clear procedure, if you try to record data in Tracks 1 to 8 without recording the Rhythm Track, the Display responds with:

```
REC  
Time 3/4 Enter
```

Set the desired time signature (1/4 to 8/4) with the Value Control Knob, then push the ENTER button. For the other Tracks, take the same procedure.

[Track Clear]

The Track Clear function erases each Track you like.

*The Rhythm Track data cannot be erased using the Track Clear function.
If you wish to erase the Rhythm Track, take the All Clear procedure,
or the erase procedure in the Rhythm Track Recording section.

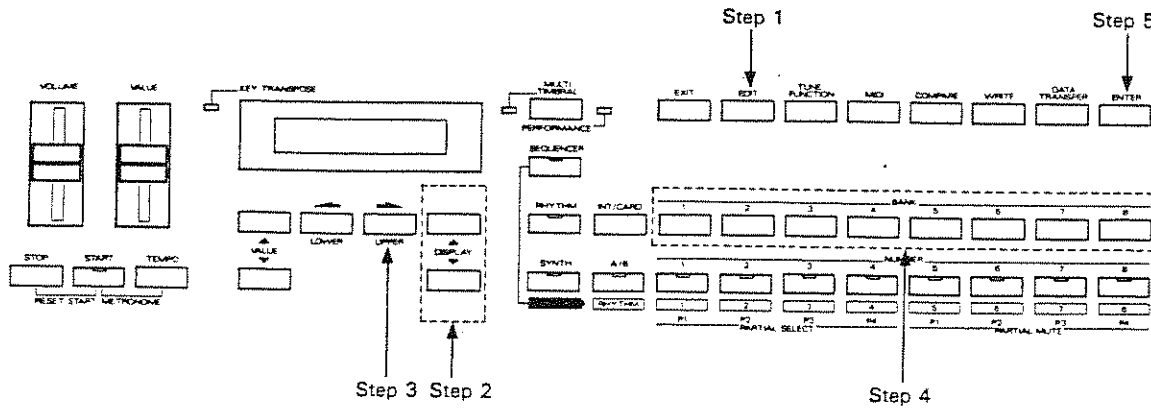

Step 1 Push the EDIT button.

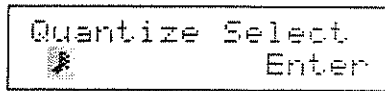

Step 2 Call the following Display using the DISPLAY buttons.

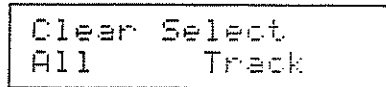

Step 3 Push the right Cursor Button.

The Display responds as below, and meanwhile, the indicator of the recorded Tracks will flash (red).

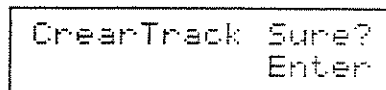

Step 4 **Select the Track to be cleared with the relevant BANK button.**

The indicator of the selected Track stops flashing, remaining alight. (The Tracks which are flashing can still be selected by pushing the corresponding BANK buttons.)

Each time a BANK button is pressed, it alternately flashes or remains alight.

Step 5 **Push the ENTER button.**

When the data is cleared, the Display responds as below, then returns to the previous display.

Complete

5) Erase

The Erase function allows you to erase only the Program Change messages or Pan/Volume messages of recorded performance data in each Track.

[Erasing Program Change Messages]

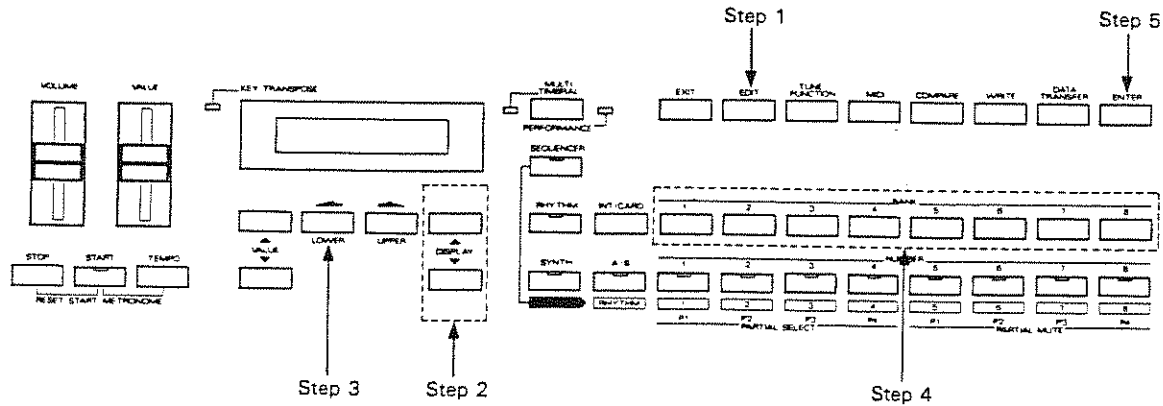

Step 1 Push the EDIT button.

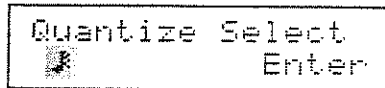

Step 2 Change to the following Display using the DISPLAY buttons.

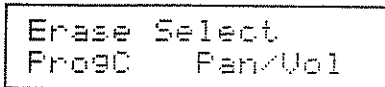

Step 3 Push the left Cursor Button.

The Display responds as below, and meanwhile, the indicator of the recorded Tracks will flash (red).

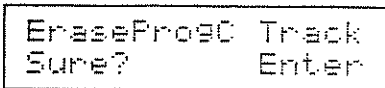

Step 4 Select the Track whose Program Change Messages are to be erased, using the relevant BANK button.

The indicator of the selected Track stops flashing, remaining alight. (The Tracks which are flashing can still be selected by pushing the corresponding BANK buttons.)

Each time a BANK button is pressed, it alternately flashes or remains alight.

Step 5 Push the ENTER button.

When the data is cleared, the Display responds as below, then returns to the previous display.

Complete

[Erasing Pan/Volume Messages]

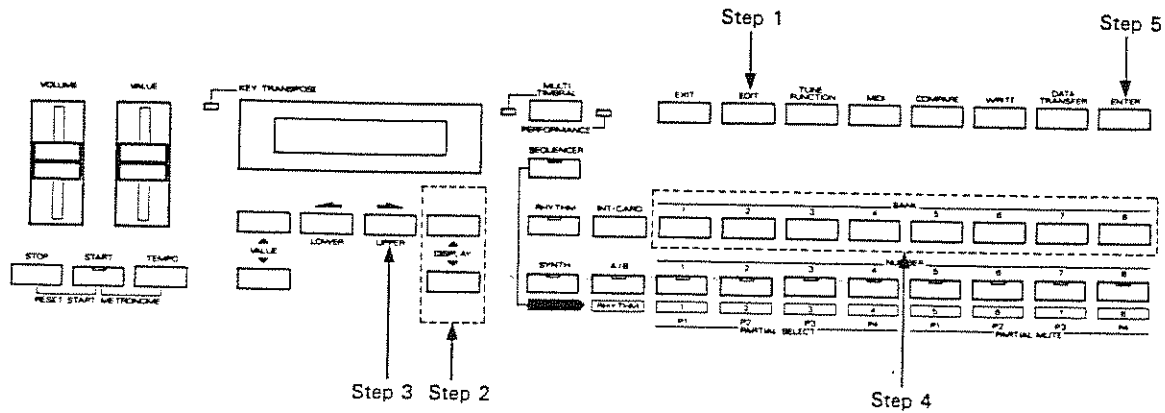

Step 1 Push the EDIT button.

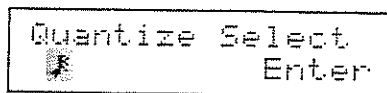

Step 2 Change to the following Display using the DISPLAY buttons.

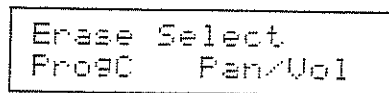

Step 3 Push the right Cursor Button.

The Display responds as below, and meanwhile, the indicator of the recorded Tracks will flash (red).

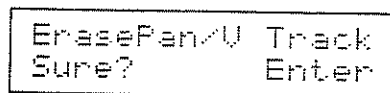

Step 4 Select the Track whose Pan and Volume are to be erased, using the relevant BANK button.

The indicator of the selected Track stops flashing, remaining alight. (The Tracks which are flashing can still be selected by pushing the corresponding BANK buttons.)

Each time a BANK button is pressed, it alternately flashes or remains alight.

Step 5 Push the ENTER button.

When the data is cleared, the Display responds as below, then returns to the previous display.

Complete

6) Quantize

The Quantize function corrects the timing of the key message so that it will conform to a set timing. This function is available in each Track of data.

*The quantized data cannot be returned to its previous condition.

*The Quantize function may cause performance in correctness as Quantize function only adjust the key Messages. When the Program Change Message and the Control Message is recorded using Overdubbing function after quantizing.

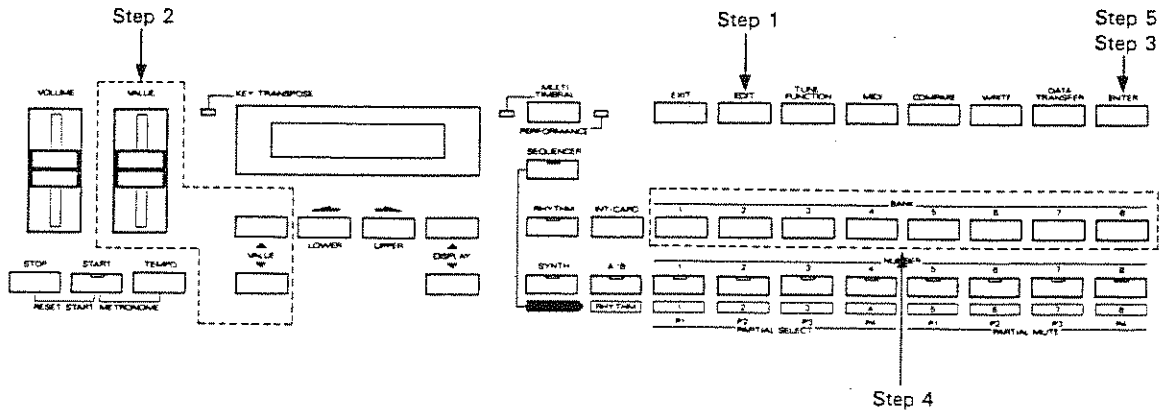

Step 1 Push the EDIT button.

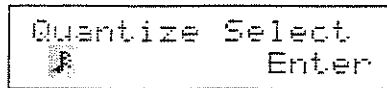

Step 2 The value for quantization is represented as a time signature. Using the Value Control Knob select the value (the shortest note) for the recorded data.

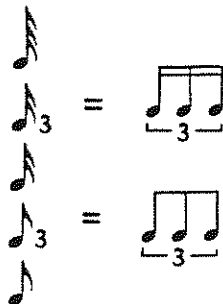

Step 3 Push the ENTER button.

The Display responds as below, and meanwhile, the indicator of the recorded Tracks will flash (red).

```
Quantize ↓ Track  
Enter
```

Step 4 Select the Track to be quantized using the relevant BANK button.

The indicator of the selected Track stops flashing, remaining alight. (The Tracks which are flashing can still be selected by pushing the corresponding BANK buttons.)

Each time a BANK button is pressed, it alternately flashes or remains alight.

Step 5 Push the ENTER button.

When the data is quantized, the Display responds as below, then returns to the previous display.

```
Complete
```

c. Song Name

The recorded performance data can be named using up to 10 letters.

*The Song Name you put here can be used as a file name for saving onto a floppy disk.

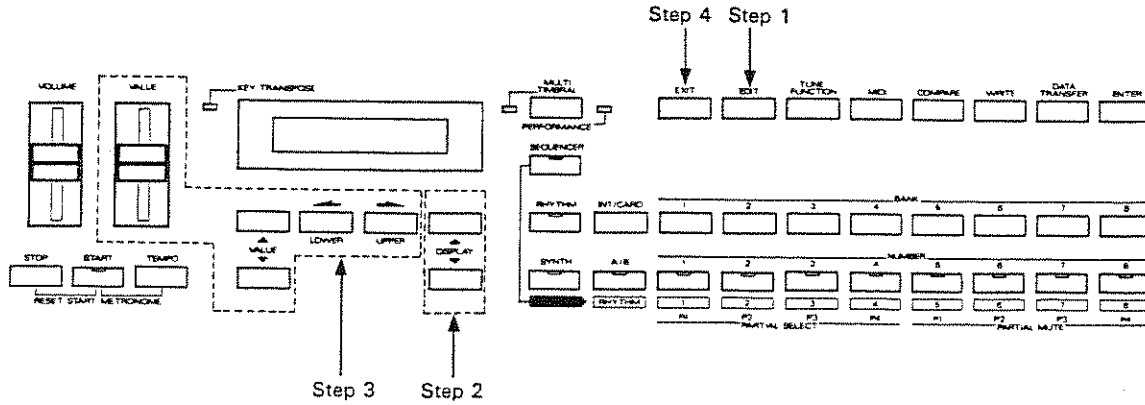

Step 1 Push the EDIT button.

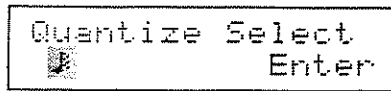

Step 2 Select the following Display using the DISPLAY buttons.

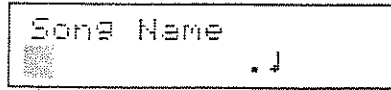

Step 3 Using the Cursor Buttons, move the cursor to the position where the selected letter is to be written, then choose the letter with the Value Control Knob.

The available letters for a Song Name are as shown below.

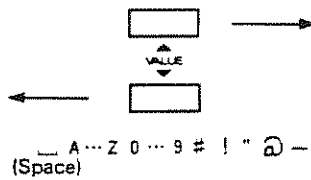

Step 4 Push the EXIT button to return to the previous Display.

3. Sequencer Play

This section describes how to play the recorded performance data in the Multi Timbral mode.

a. Play Mode

In the Play mode, you can call any Timbre you like while playing back the performance data.

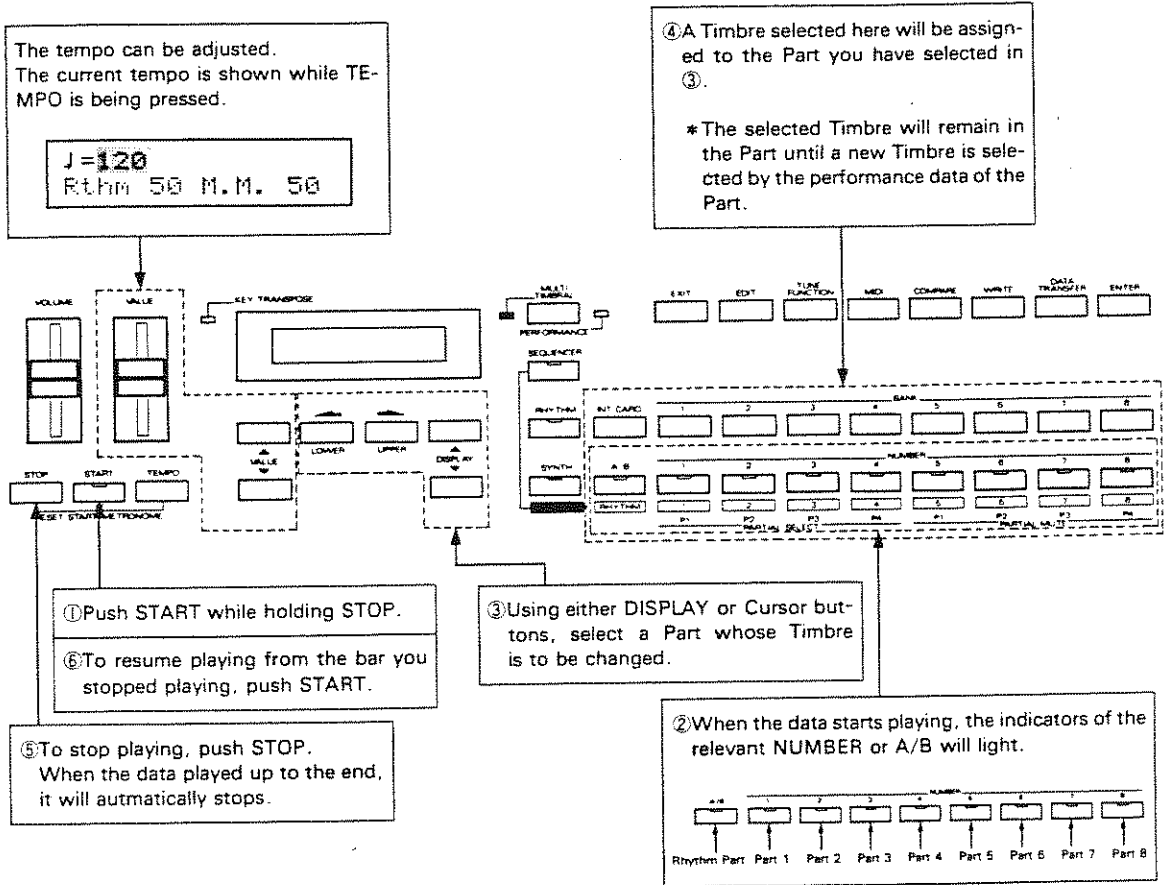

b. Sequencer Mode

The Sequencer mode includes the following procedures.

[Selecting Tracks to be played]

By pressing the A/B or NUMBER buttons lit in green, you can mute the corresponding Tracks. In this way, you can playback only the Tracks you want. Pressing the button alternately turns ON or OFF the Muting function.

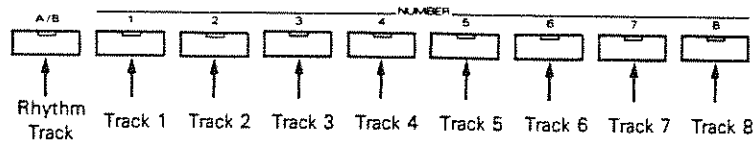

[Playback from any bar]

It is possible to playback data from any bar you like.

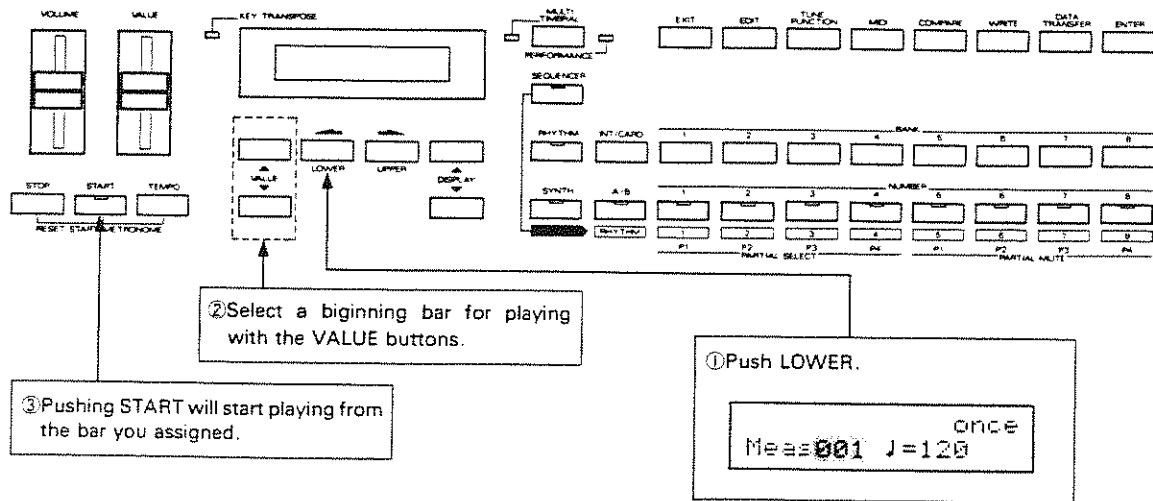

*The data played back uses a Timbre/Patch or Pan/Volume setting selected before assigning the bar, and therefore may sound different from the data actually recorded.

[Repeat Play]

It is possible to playback the recorded performance data repeatedly.

*The Repeat function you have turned on will return to "once" when the unit is switched off.

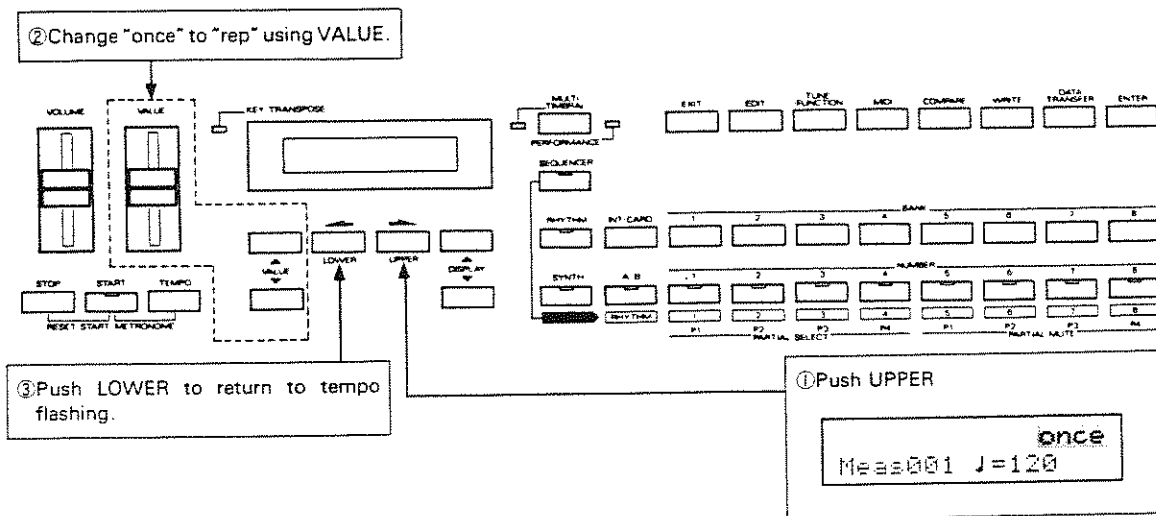

[Other Useful Functions]

● Rhythm Pattern Number

Pressing the Display (▲) button will indicate the tempo and rhythm pattern alternately.



● Total Time Display

As long as the stop and Display (▼) buttons are held down, the total time (based on the current tempo) of the song data is shown in the display.

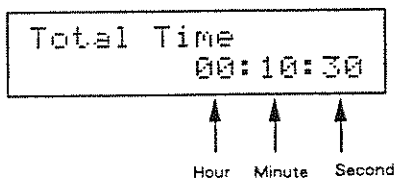

*When the Clock Mode is set to MIDI, the total time is not displays.

3 EDIT

1. Rhythm Setup

Rhythm Tones are assigned to the Key Numbers C1 to C8. When Key messages are received by the Rhythm Part, the Rhythm Tone assigned to that Key Number is played, resulting in rhythm performance.

Each Key Number can have an independent Pan and Level, allowing rhythm performance in a desired balance. As well as the Preset Rhythm Tones (63 kinds), original Tones you have programmed can be used as Rhythm Tones.

a. Editing Procedure

*The Editing procedure does not automatically rewrite old data. Therefore, the edited data will be erased if the unit is turned off. If you wish to retain the edited version even after the unit is turned off, take the appropriate writing procedure (page 85) for each Key Number.

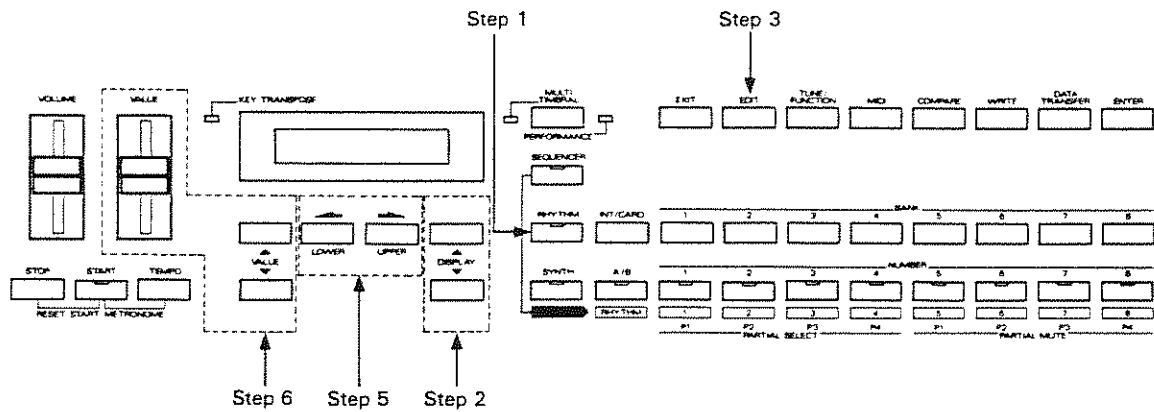

Step 1 Push the RHYTHM button (the indicator lights up).

Step 2 Using the DISPLAY buttons, change to the Manual Drum Display.

```
Manual Drum
P-11: ▲▲▲▲▲▲▲▲▲▲▲▲▲▲▲▲
```

Step 3 Push the EDIT button.

Now, the keyboard is ready for manual rhythm performance.

```
Key C2 Tone r01
L100 P > R OFF
```

*The Key-Rhythm Tone assignment preprogrammed by the manufacturer is shown on page 84.

Step 4 Push the key to be edited.

If you wish to select a key that exceeds the maximum range of the keyboard, transpose the pitch of the keyboard using the DISPLAY buttons before assigning the key. When the keyboard is transposed, the Key Transpose Indicator lights up.

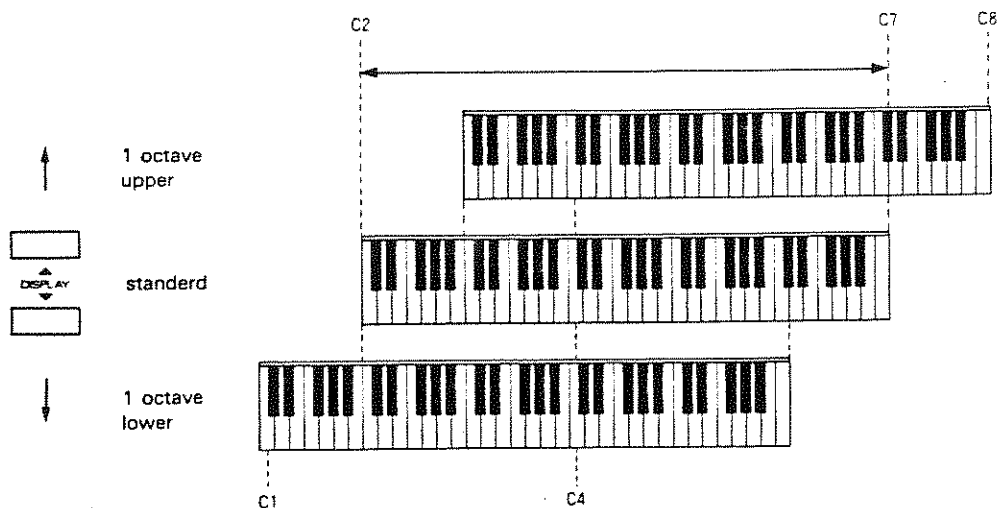

Step 5 Using the Cursor Buttons, call the parameter to be edited.

The value of the selected parameter flashes.

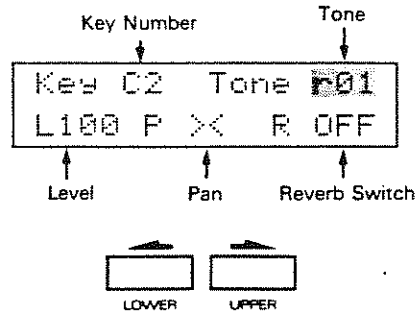

Step 6 Change the value using the Value Control Knob.

Tone : A Rhythm Tone (from the Preset Rhythm Tones r1 to r63, and Internal Tones i1 to i64) can be selected. At OFF, no Rhythm Tone is assigned.

Level : The level of the volume can be set from 0 to 100. Higher values increase the volume.

Pan : The positioning of the sound image in the stereo output can be set from 7> to <7. At ><, the position is in the center, <7 the far right, >7 far left.

Reverb Switch : Turn this ON to obtain the reverb effect.

*The rhythm patterns are programmed using the Rhythm Tones which have been assigned to specific Key Numbers, and therefore may be changed after the assignment is edited.

*When a Rhythm Tone from the internal memory is used, the pitch may be changed depending on the key assigned to the Tone.

*Changing the Pan value may not affect the sound as expected in some Tones because of the Structure setting. (see page 109)

*When using a Tone made by using only one Partial, 8 panning positions are available.

*When an Internal Tone (11 to 64) is used as a Rhythm Tone, the ENV mode (see page 124) of the Tone is automatically set to NO SUSTAIN (therefore it may sound different). This, however, does not apply to a rhythm tone in Track 8 or that played by MIDI messages sent from an external keyboard or device, then it is played according to the ENV mode setting. So, when you are making a Rhythm Tone, it may be necessary to set a NO SUSTAIN envelope.

Step 7 To write the edited parameter, take the appropriate writing procedure (as explained on page 85.)

Step 8 Push the EXIT button to retrieve the Manual Drum Display.

[Preset Rhythm Tones]

[Preprogrammed Rhythm Setup]

No.	Tone Name	Number of Partial
r01	Closed High Hat-1	1
r02	Closed High Hat-2	1
r03	Open High Hat-1	2
r04	Open High Hat-2	2
r05	Crash Cymbal	2
r06	Crash Cymbal (short)	1
r07	Crash Cymbal (mute)	1
r08	Ride Cymbal	2
r09	Ride Cymbal (short)	1
r10	Ride Cymbal (mute)	1
r11	Cup	2
r12	Cup (mute)	1
r13	China Cymbal	2
r14	Splash Cymbal	1
r15	Bass Drum-1	2
r16	Bass Drum-2	1
r17	Bass Drum-3	2
r18	Bass Drum-4	1
r19	Snare Drum-1	1
r20	Snare Drum-2	1
r21	Snare Drum-3	1
r22	Snare Drum-4	2
r23	Snare Drum-5	1
r24	Snare Drum-6	1
r25	Rim Shot	1
r26	Brush-1	2
r27	Brush-2	2
r28	High Tom Tom-1	1
r29	Middle Tom Tom-1	1
r30	Low Tom Tom-1	1
r31	High Tom Tom-2	1
r32	Middle Tom Tom-2	1
r33	Low Tom Tom-2	1
r34	High Tom Tom-3	2
r35	Middle Tom Tom-3	2
r36	Low Tom Tom-3	2
r37	High Pitch Tom Tom-1	1
r38	High Pitch Tom Tom-2	1
r39	Hand Clap	1
r40	Tambourine	1
r41	Cowbell	1
r42	High Bongo	1
r43	Low Bongo	1
r44	High Conga (mute)	1
r45	High Conga	1
r46	Low Conga	1
r47	High Timbale	1
r48	Low Timbale	1
r49	High Agogo	1
r50	Low Agogo	1
r51	Cabasa	1
r52	Maracas	1
r53	Short Whistle	2
r54	Long Whistle	2
r55	Quijada	3
r56	Claves	1
r57	Castanets	2
r58	Triangle	2
r59	Wood Block	1
r60	Bell	2
r61	Native Drum-1	1
r62	Native Drum-2	1
r63	Native Drum-3	1
OFF		0

r63	Native Drum-3	
r62	Native Drum-2	C7
r61	Native Drum-1	
r09	Ride Cymbal (short)	
r34	High Tom Tom-3	
r06	Crash Cymbal (short)	
r35	Middle Tom Tom-3	
r02	Closed High Hat-2	
r36	Low Tom Tom-3	
r24	Snare Drum-6	
r23	Snare Drum-5	
r22	Snare Drum-4	
r18	Bass Drum-4	
r17	Bass Drum-3	C6
r60	Bell	
r59	Wood Block	
r37	High Pitch Tom Tom-1	
r58	Triangle	
r38	High Pitch Tom Tom-2	
r57	Castanets	
r27	Brush-2	
r26	Brush-1	
r56	Claves	
r12	Cup (mute)	
r55	Quijada	
r54	Long Whistle	C5
r53	Short Whistle	
r52	Maracas	
r51	Cabasa	
r50	Low Agogo	
r49	High Agogo	
r48	Low Timbale	
r47	High Timbale	
r46	Low Conga	
r45	High Conga	
r44	High Conga (mute)	
r43	Low Bongo	C4 (Middle C)
r42	High Bongo	
r10	Ride Cymbal (mute)	
r21	Snare Drum-3	
r07	Crash Cymbal (mute)	
r41	Cowbell	
r14	Splash Cymbal	
r40	Tambourine	
r11	Cup	
r13	China Cymbal	
r08	Ride Cymbal	
r31	High Tom Tom-2	
r05	Crash Cymbal	
r28	High Tom Tom-1	C3
r32	Middle Tom Tom-2	
r03	Open High Hat-1	
r29	Middle Tom Tom-1	
r04	Open High Hat-2	
r33	Low Tom Tom-2	
r01	Closed High Hat-1	
r30	Low Tom Tom-2	
r20	Snare Drum-2	
r39	Hand Clap	
r19	Snare Drum-1	
r25	Rim Shot	
r16	Bass Drum-2	C2
r15	Bass Drum-1	

b. Writing Procedure

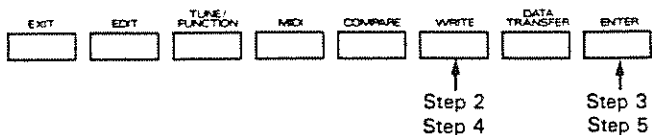

Step 1 Push the key to be edited.

Step 2 Push the WRITE button.

```
Write C4 Setup
Sure?      Enter
```

Step 3 Push the ENTER button.

```
Turn Protect off
once? Write/Exit
```

Step 4 Push the WRITE button.

The Memory Protect function is cancelled temporarily and the Display is returned to that in Step 2.

Step 5 Push the ENTER button.

If the writing procedure is completed, the Display responds as shown below, then returns to the Edit Display.

```
Complete
```

2. Patch and Timbre

A Patch (in the Performance mode) and Timbre (in the Multi Timbral Mode) consists of various parameters. How the Tones are played will be changed by editing these parameter values.

a. Patch

1) Editing Procedure

Turn to the Performance Play mode (the Performance and Synth Indicators light up), then take the following procedure.

*Your edited version does not automatically rewrite existing data, and therefore will be erased when a different Patch is selected or the unit is turned off. To retain the edited data, take the appropriate writing procedure (see page 101).

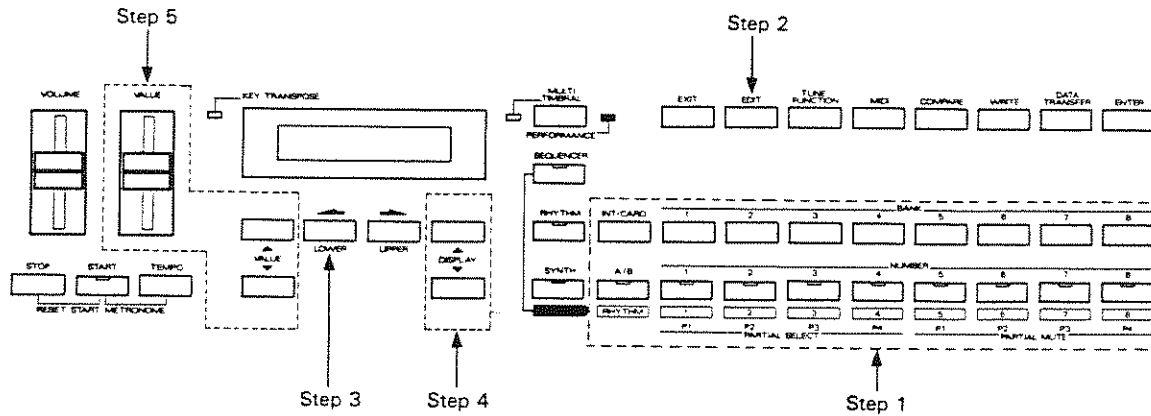

Step 1 Call the Patch to be edited.

Step 2 Push the EDIT button.

```

Edit Select
Patch Tone
    
```

Step 3 Push the left Cursor Button.

```

Key Mode
SPLIT
    
```

Step 4 **Select the parameter to be edited using the DISPLAY buttons.**

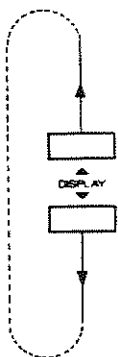

- Patch Name
- Patch Level
- Tone Balance
- Reverb Level
- Reverb Time
- Reverb Type
- Reverb Switch (Lower/Upper)
- Assign Mode (Lower/Upper)
- Bender Range (Lower/Upper)
- Fine Tune (Lower/Upper)
- Key Shift (Lower/Upper)
- Tone Select (Upper)
- Tone Select (Lower)
- Split Point
- Key Mode

*If more than two values are shown in the Display, select one of those using the Cursor Buttons. The selected value will flash showing it is ready to be edited.

Step 5 **Change the value with the Value Control Knob.**

Step 6 **Repeat Steps 4 and 5 as many times as necessary.**

Step 7 **To write the value you have set, go to the writing procedure (page 101).**

*To leave the Patch editing mode, push the EXIT button.

2) Patch Parameters

A Patch is made of the following parameters.

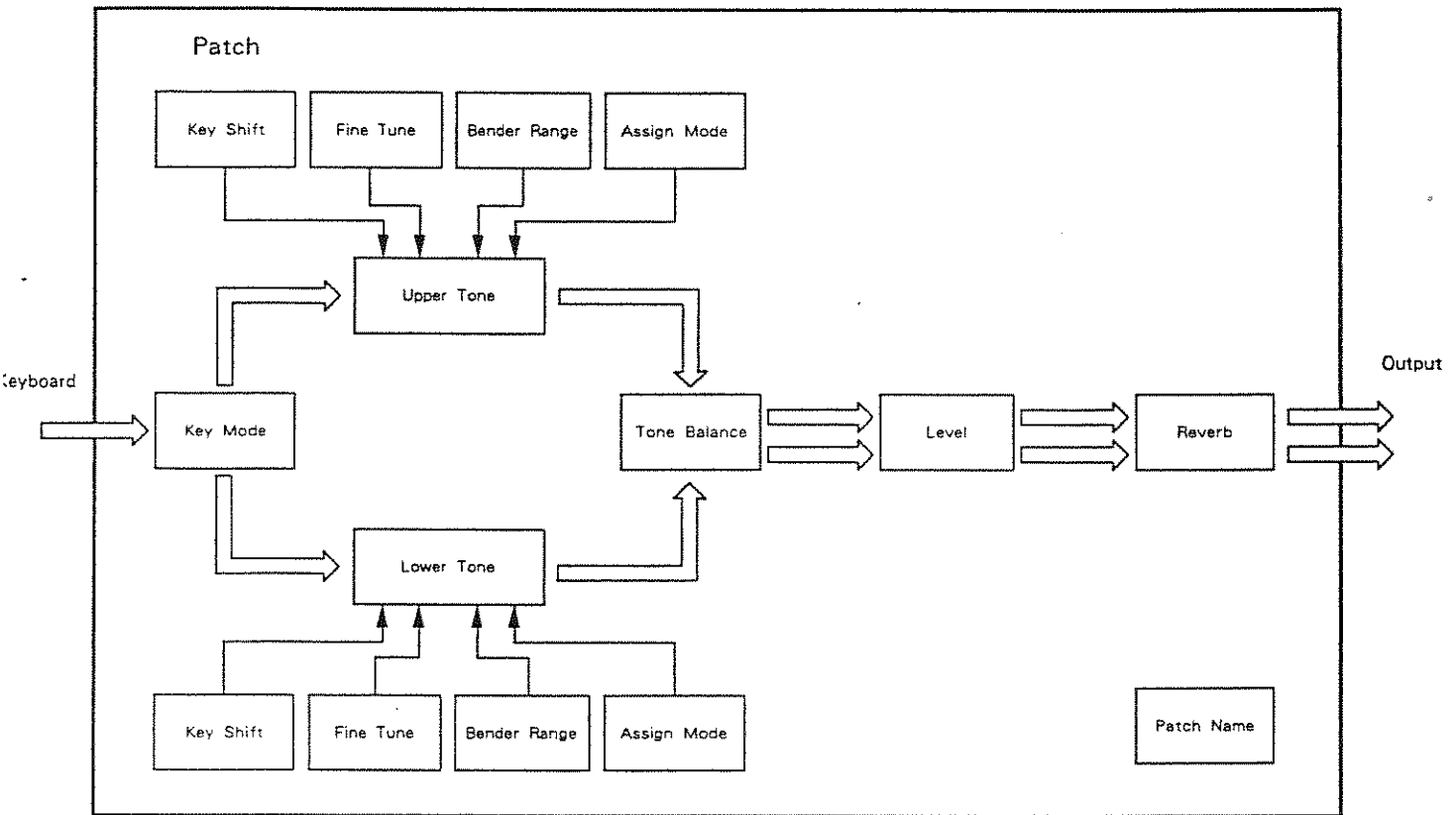

● Key Mode

```
Key Mode  
SPLIT
```

Key Mode refers to how the Upper and Lower Tones are played on the keyboard.

WHOLE : Only the Upper Tone is played. Use this mode for playing a piano type sound which requires many voices (notes).

DUAL : Both the Upper and Lower Tones are played simultaneously. This is ideal for strings or organ type sounds.

SPLIT : The Split mode divides the keyboard into the upper and lower sections, where two different Tones can be played simultaneously.

● Split Point

```
Split Point  
C4
```

In the Split Key mode, the key where the keyboard is divided into two sections, upper and lower sections, is called the Split Point. The Split Point can be set in the range of C2 to C#7 in semi-tone steps.

● Tone Select

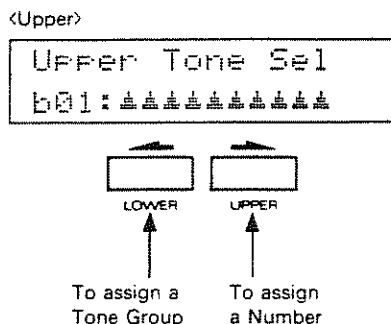
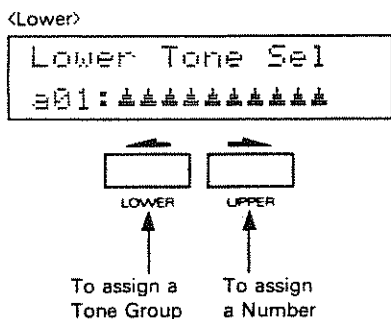

This selects the Tones which are to be assigned to the upper and lower sections of the keyboard. Depending on which memory, internal memory or memory card the Patch belongs to, the available Tones will differ.

	Internal		Memory Card	
Tone Group	a, b, i	r	a, b, c	r
Number	1-64	1-63, OFF	1-64	1-63, OFF

- a : Preset Tone (Internal)
- b : Preset Tone (Internal)
- r : Preset Rhythm Tone (Internal)
- i : Programmable Tone (Internal)
- c : Tone a memory card

● Key Shift

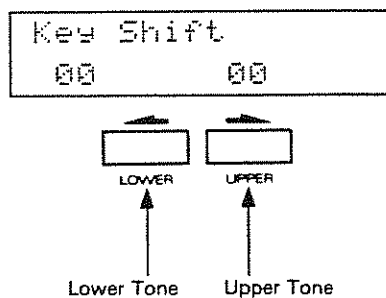

The relative pitch of the Upper and Lower Tones can be separately set from -24 to $+24$ (2 octaves) in semi-tone steps.

● Fine Tune

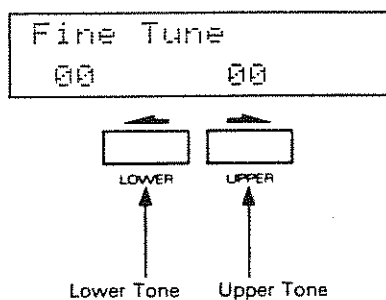

The pitch of each Tone can be finely changed from -50 to $+50$ (about ± 50 cents).

● Bender Range

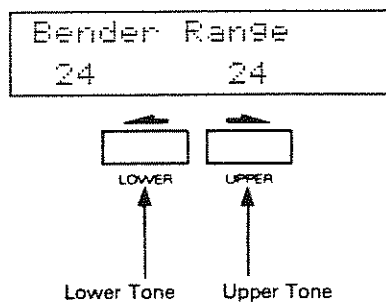

This sets the variable range of the pitch change caused by moving the Bender Lever right and left from 0 to 24 (2 octaves) in semi-tone steps.

● Assign Mode

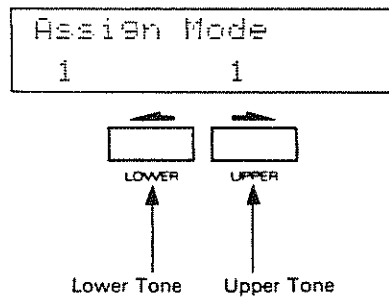

Assign mode refers to how each Tone should be played by Key messages received.

- 1 : Single Assign—Played with Last Note Priority
- 2 : Single Assign—Played with First Note Priority
- 3 : Multi Assign—Played with Last Note Priority
- 4 : Multi Assign—Played with First Note Priority

SINGLE ASSIGN

In this mode, when more than one Key ON message is received by the same Key Number, the sound of that key is muted once, then played again.

MULTI ASSIGN

In this mode, when more than one Key ON message is received by the same Key Number, two sounds are mixed.

LAST NOTE PRIORITY

In this mode, when the D-20 has received more than 32 Key ON messages, the previously received ones are replaced by the later received ones.

FIRST NOTE PRIORITY

In this mode, when the D-20 has received more than 32 Key On messages, the later received ones are ignored, retaining the currently playing sounds.

● Reverb Switch

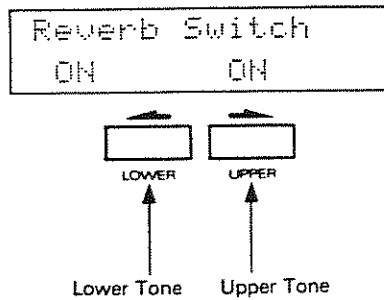

This selects whether to use the Reverb effect or not individually for each Tone. ON turns the effect on.

● Reverb Type

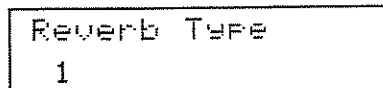

One of the 8 Reverb Types can be selected. At OFF, no reverb effect is obtained.

Number	Reverb Type
1	Small Room
2	Medium Room
3	Medium Room
4	Large Hall
5	Plate
6	Delay 1
7	Delay 2
8	Delay 3
OFF	No Reverb

● Reverb Time

```
Reverb Time
 01
```

Reverberation times can be set from 1 to 8. Higher values refer to longer reverb times.(When a delay effect is selected, = delay times.)

● Reverb Level

```
Reverb Level
 04
```

This sets the volume of the reverb sound from 0 to 7. Higher values increase the volume.

● Tone Balance

```
Tone Balance
 30      70
  ↑      ↑
Volume of Lower Tone  Volume of Upper Tone
```

The volume balance of the Upper and Lower Tones can be changed. The total amount of the two Tones is always 100. At 50, both levels are equal.

● Patch Level

```
Patch Level
 80
```

The volume of a Patch can be set from 0 to 100. Using this parameter, the volume balance between two different Patches can be adjusted.

● Patch Name

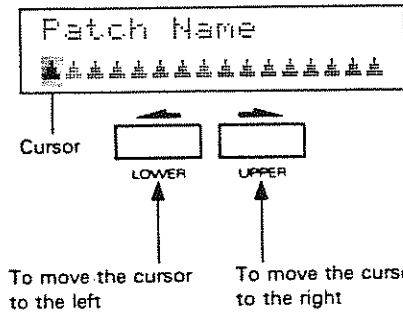

A Patch can be named using 16 letters. Move the cursor to the letter you wish to change by using the Cursor Buttons, then change the letter with the Value Control Knob. The letters available for naming a Patch are shown below.



A...Z, a...z, 0...9, & # ! ? . , : ; " * + - / < = >
(Space)

b. Timbre

1) Editing Procedure

Turn to the Multi Timbral mode (the Multi Timbral and Synth Indicators light up), then take the following procedure.

*Your edited version does not automatically rewrite existing data, and therefore will be erased when a different Timbre is selected or the unit is turned off. To retain the edited data, take the appropriate writing procedure (see pge 101).

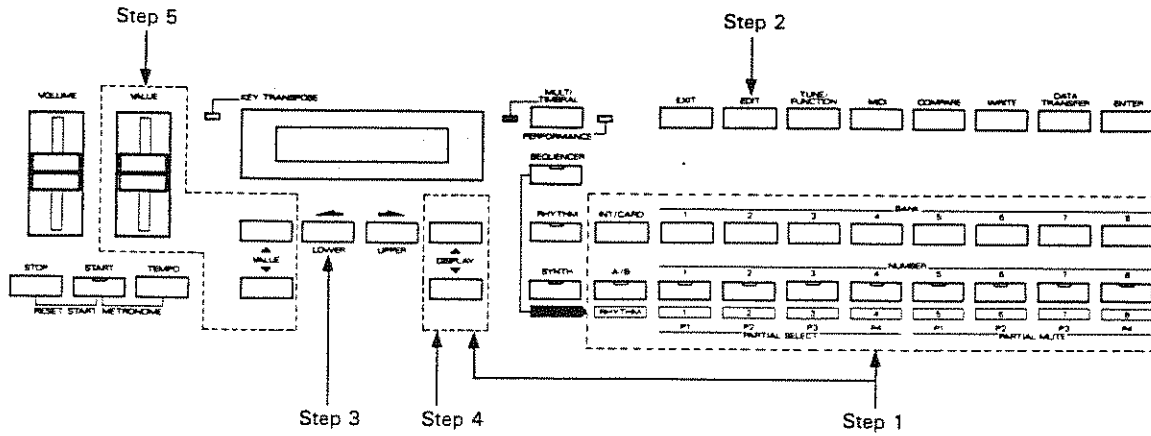

Step 1 Call the Timbre to be edited.

To edit a Timbre assigned to any Part, call the relevant Part Display using the DISPLAY buttons.

To edit a Timbre which is not assigned to any Part, you can use any Part Display.

Step 2 Push the EDIT button.

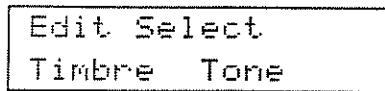

Step 3 Push the left Cursor Button.

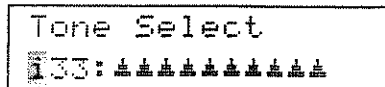

Step 4 **Select the parameter to be edited using the DISPLAY buttons.**

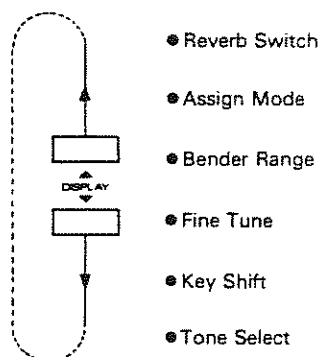

Step 5 **Change the value with the Value Control Knob.**

Step 6 **Repeat Steps 4 and 5 as many times as necessary.**

Step 7 **To write the value you have set, go to the writing procedure (page 101).**

***To leave the Timbre editing mode, push the EXIT button.**

2) Timbre Parameters

A Timbre is made of the following parameters.

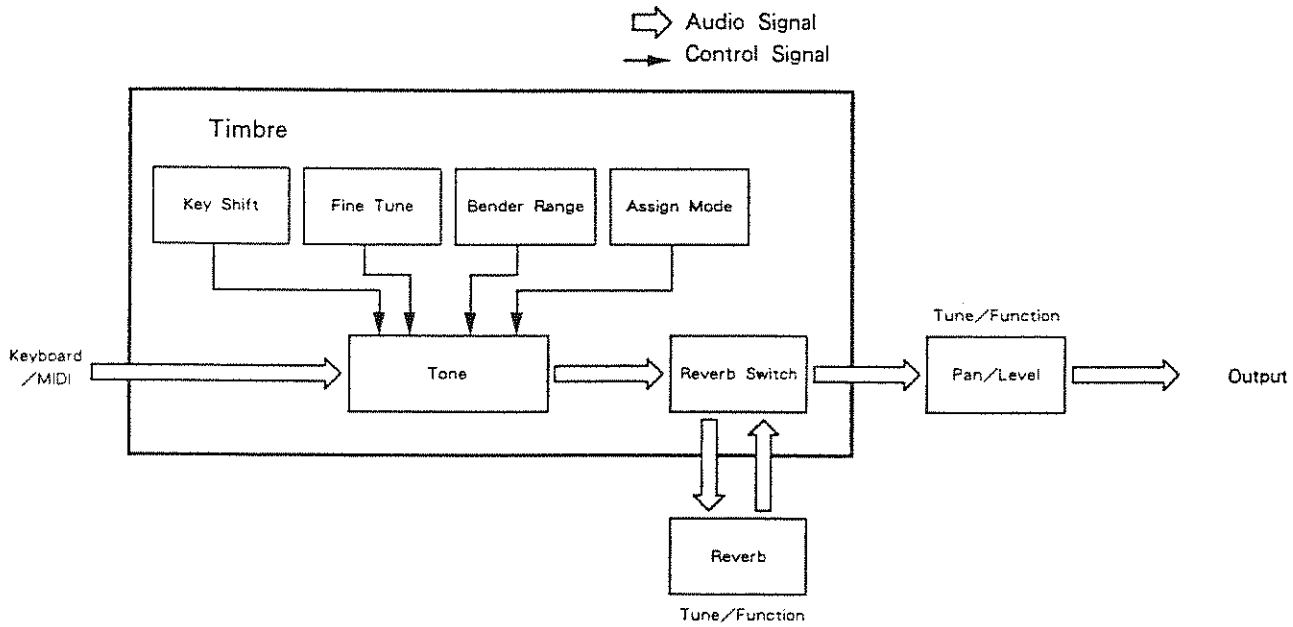

● Tone Select

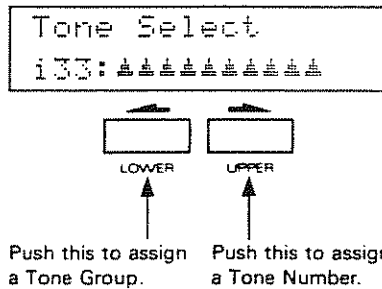

This selects a Tone which is to be assigned to a Timbre. Depending on which memory, the internal memory or memory card the Timbre belongs to, the available Tones will differ.

Tone Group	Internal		Memory Card	
		a, b, i	r	a, b, c
Number	1-64	1-63, OFF	1-64	1-63, OFF

- a : Preset Tone (Internal)
- b : Preset Tone (Internal)
- r : Preset Rhythm Tone (Internal)
- i : Programmable Tone (Internal)
- c : Tone a memory card

● Key Shift

Key Shift 00

The pitch of the Tone can be set from -24 to +24 (2 octaves) in semi-tone steps.

● Fine Tune

Fine Tune 00

The pitch of a Tone can be finely changed from -50 to +50 (about ± 50 cents).

● Bender Range

Bender Range 24

This sets the variable range of the pitch change caused by moving the Bender Lever right and left from 0 to 24 (2 octaves) in semi-tone steps.

● Assign Mode

```
Assign Mode
1
```

The Assign mode refers to how each Tone should be played by Key messages received.

- 1 : Single Assign—Played with Last Note Priority
- 2 : Single Assign—Played with First Note Priority
- 3 : Multi Assign—Played with Last Note Priority
- 4 : Multi Assign—Played with First Note Priority

SINGLE ASSIGN

In this mode, when more than one Key ON message is received by the same Key Number on the same MIDI channel, the sound of that key is muted once, then played again.

MULTI ASSIGN

In this mode, when more than one Key ON message is received by the same Key Number on the same MIDI channel, two sounds are mixed.

LAST NOTE PRIORITY

In this mode, when the D-20 has received more than 32 Key ON messages, the previously received ones are replaced by the later received ones.

FIRST NOTE PRIORITY

In this mode, when the D-20 has received more than 32 Key On messages, the later received ones are ignored, retaining the currently playing sounds.

● Reverb Switch

```
Reverb Switch
OFF
```

This selects whether to use the Reverb effect or not individually for each Tone. ON turns the effect on.

c. Writing Procedure

If you wish to retain your edited Patch or Timbre, write it into the internal memory or onto an optional memory card (M-256D, M-256E).

1) Writing into the internal memory

To write the edited data into the internal memory, do as follows.

*If you write the Patch or Timbre on a memory card into the D-20's internal memory, a Tone of "c" group will be automatically replaced with a Tone of "i" group. Therefore, the contents of a Patch or Timbre will be changed. To avoid this, first write the Tone on the memory card into the internal memory. (See page 146.)

[Memory Protect]

The Memory Protect function is provided for preventing data in memory from accidental erasure. To write data into the internal memory, you should turn off the Memory Protect of the D-20.

There are two types of Memory Protect OFF as follows :

<Temporary Type Memory Protect OFF during Writing>

This turns the Memory Protect function OFF just for one action of writing, then automatically returns to Protect ON right after. If you need to turn off the Memory Protect just once, such as when writing edited data, this type of Protect OFF will be sufficient.

<Normal Type Memory Protect OFF>

This type of Memory Protect OFF is retained until it is returned to ON, and therefore may be required when you need to write repeatedly.

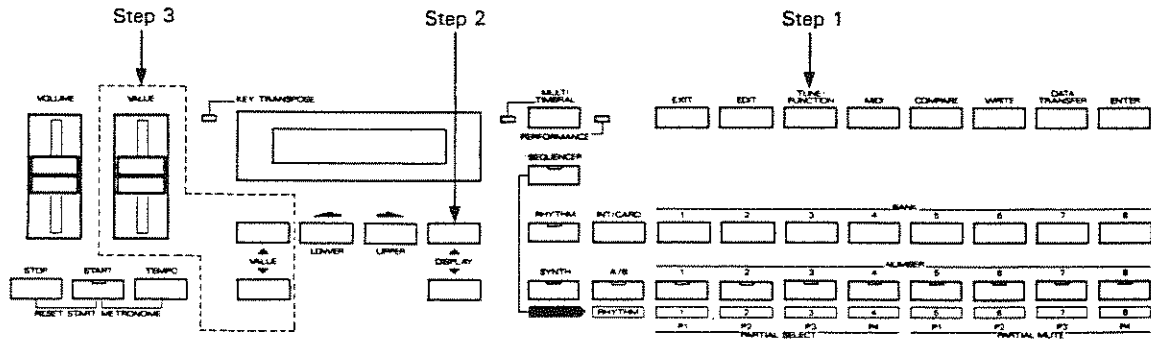

Step 1 Push the TUNE/FUNCTION button.

Step 2 Push the DISPLAY ▲ button.

The Memory Protect Display will appear.

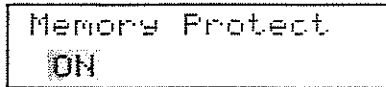

Step 3 Set the Memory Protect to OFF using the Value Control Knob.

*Be sure to return the Memory Protect to ON whenever you have finished writing.

*The D-20 defaults to Memory Protect ON.

[Writing Procedure]

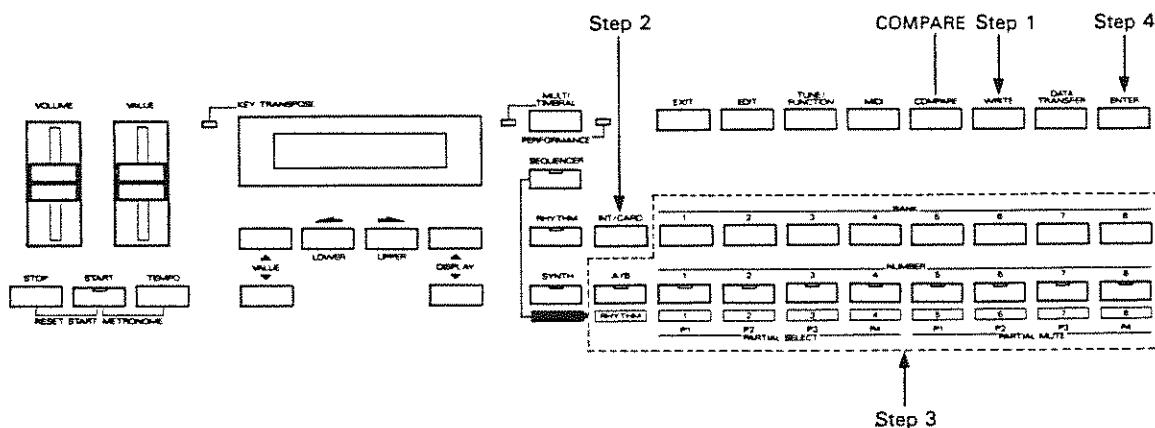

Step 1 Push the WRITE button.

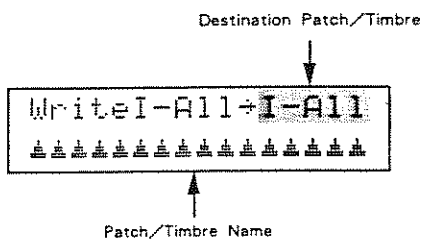

Step 2 If you have edited a Patch or Timbre on a memory card, push the INT/CARD button to change to "I" (Internal mode).

Step 3 To change the destination Patch or Timbre number, use the A/B, BANK and NUMBER buttons.

If you wish to listen to the destination Patch or Timbre, do as follows.

① Push the COMPARE button.

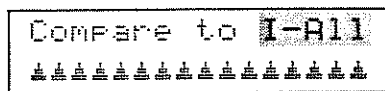

② Using the A/B, BANK and NUMBER buttons, assign the destination Patch or Timbre number.

Now, the relevant sound will be heard by playing any key on the keyboard.

③ Push the COMPARE button to return to the previous Display.

Step 4 Push the ENTER button.

When the Memory Protect function has been turned OFF, the Display responds as shown below for a while, then returns to the Play Mode Display.

```
Complete
```

If the Memory Protect has been set to ON, the Display shows as below.

```
Turn Protect off  
once? Write/Exit
```

If you wish to turn the Memory Protect OFF (=Temporary Memory Protect OFF during writing) here, push the WRITE button then the ENTER button.

*If the writing procedure is not completed properly, an Error Message will be shown instead. If so, resolve it as shown on page 212 "Error Messages".

2) Writing onto a Memory Card

*When using a brand new memory card, take the "Saving" procedure (see page 189) to copy the entire data onto the memory card, before writing the Patch or Timbre data.

*If you write the Patch or Timbre in the D-20's internal memory onto a memory card, a Tone of i group will be automatically replaced with a Tone of c group. Therefore, the contents of a Patch or Timbre will be changed. To avoid this, first write the Tone in the internal memory onto the card. (See page 146.)

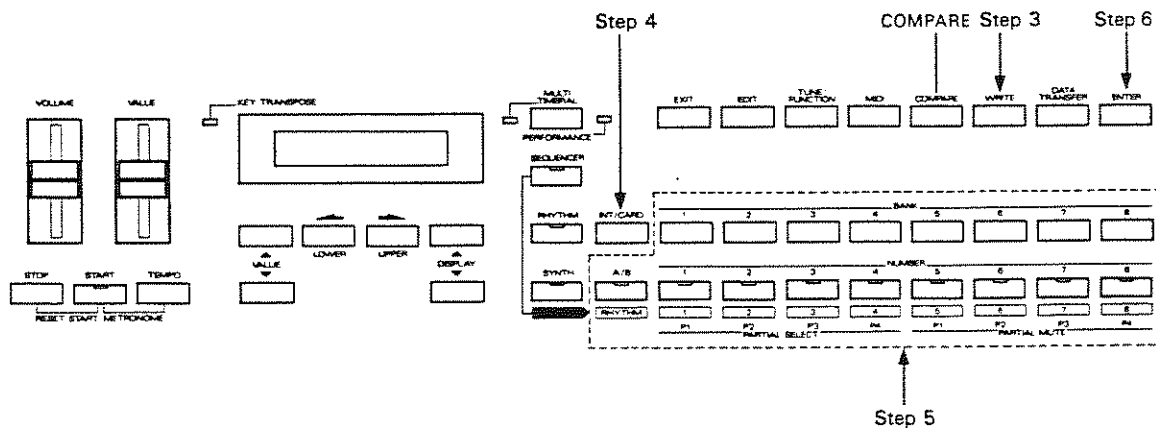

- Step 1 Insert a memory card into the Card Slot.
- Step 2 Set the Protect Switch on the memory card to the OFF position.

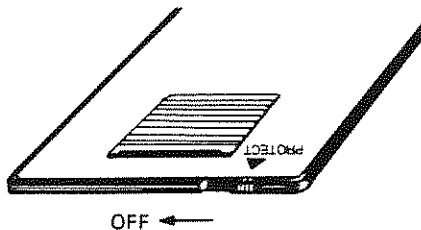

- Step 3 Push the **WRITE** button

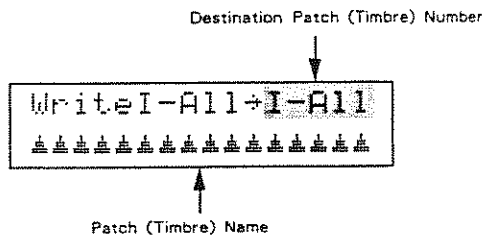

Step 4 If you have edited a source Patch or Timbre in the internal memory, change to "c" by pushing the INT/CARD button.

Step 5 If you wish to change the destination Patch or Timbre number, use the A/B, BANK and NUMBER buttons.

If you wish to listen to the destination Patch or Timbre, do as follows.

① Push the COMPARE button.

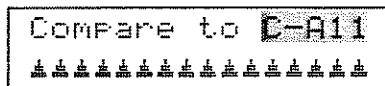

② Using the A/B, BANK and NUMBER buttons, assign the destination Patch or Timbre number.

Now, the relevant sound will be heard by playing any key on the Keyboard..

③ Push the COMPARE button to return to the previous Display.

Step 6 Push the ENTER button.

When completed, the Display shows as below for a while and then returns to the Play Mode Display.

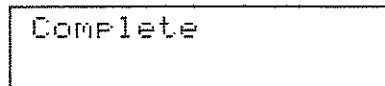

*If the writing procedure is not properly completed, an Error Message will appear instead. See page 212 "Error Messages" to resolve this.

Step 7 Return the Protect Switch on the memory card to the ON position.

3. Tone

Please read "LA System" on page 200 together with this chapter.

a. The Basic Concept of a Tone

1) Partial and Structure

The basic concept of Tone as shown below.

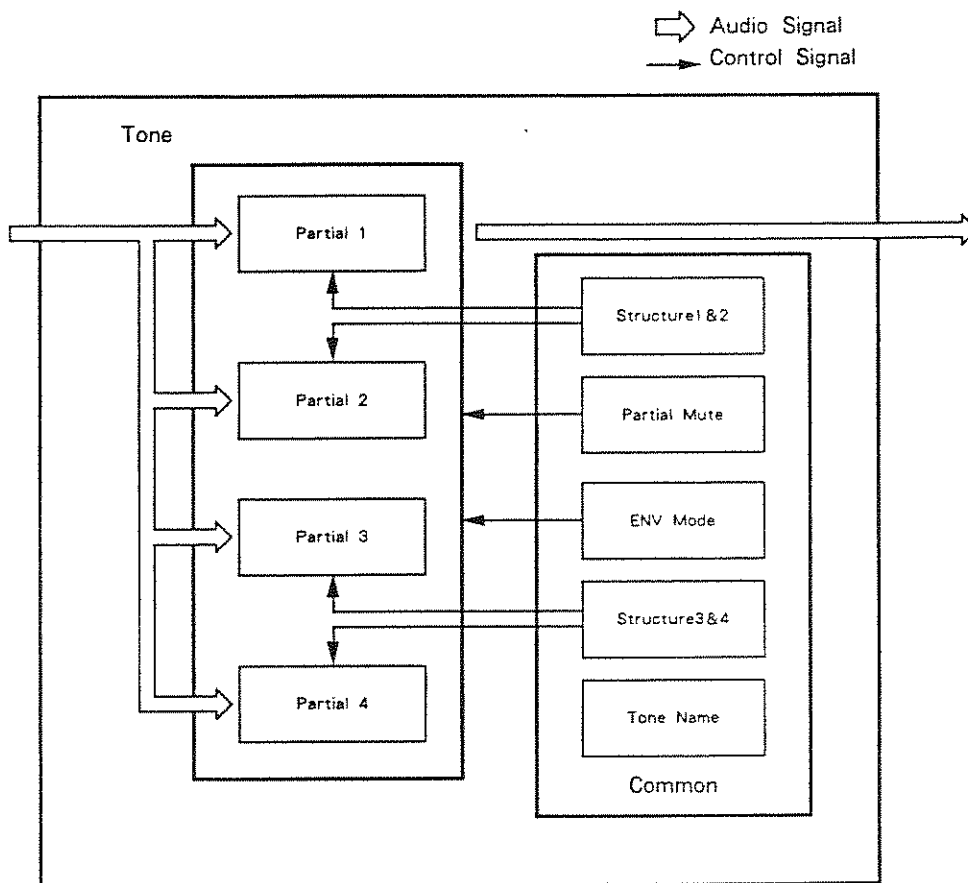

A Tone consists of four Partials and a Common block. The Partials are combined in pairs, and two pairs of partials form a Tone. An important parameter called "Structure" decides how each pair of Partials should be combined, or which sound generator should be used for each Partial. COMMON parameters are common to both Tones.

[Functions of the Structure]

(1) **Selects a sound generator to be used for each Partial.**

The Structure selects which of the two sound generators, a synthesizer sound generator or a PCM sound generator.

Synthesizer Sound Generator

⇒ This synthesizer behaves like a conventional analog synthesizer.

PCM Sound Generator

⇒ This behaves like a PCM sampled synthesizer.

(2) **Determines how to combine two Partials.**

There are four different ways to combine Partials :

○ **Mixing two Partials**

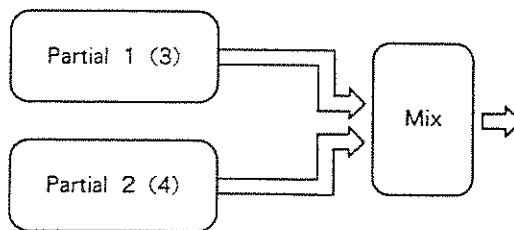

○ Sending two Partial sounds in stereo. This combination is effective for Timbres or Rhythm Tones in stereo. However, if using this setting for Patches in monaural output, this will have exactly the same effect as above "Mixing two Partials".

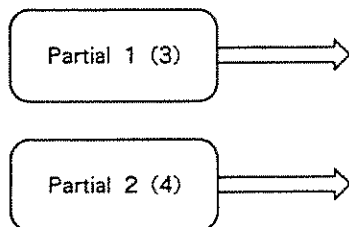

*When this Structure is selected, the condition of each Partial is automatically set as follows depending on the pan setting.

Value of Pan	Actual Value	
	Partial 1 (3)	Partial 2 (4)
<7	<7	<7
<6	<5	<7
<5	<3	<7
<4	<1	<7
<3	1>	<7
<2	3>	<7
<1	5>	<7
><	7>	<7
1>	7>	<5
2>	7>	<3
3>	7>	<1
4>	7>	1>
5>	7>	3>
6>	7>	5>
7>	7>	7>

○ Partial 1 (or 3) is mixed with the ring modulated sound of two Partials (including Partial 1).

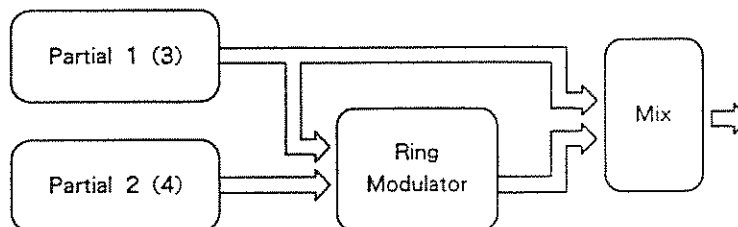

○ Two Partial^s are ring-modulated and sent out.

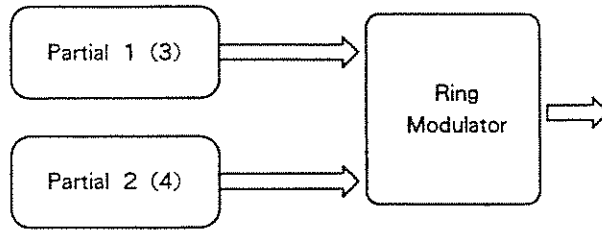

The Ring Modulator can be effectively used for creating metallic sounds, since it can increase harmonics by multiplying two Partial^s.

2) Partial

Depending on which generators are selected in the Partial Block, greatly different parameters will be used. Some parameters used for the synthesizer sound generators are irrelevant to the PCM generator. See the diagram below.

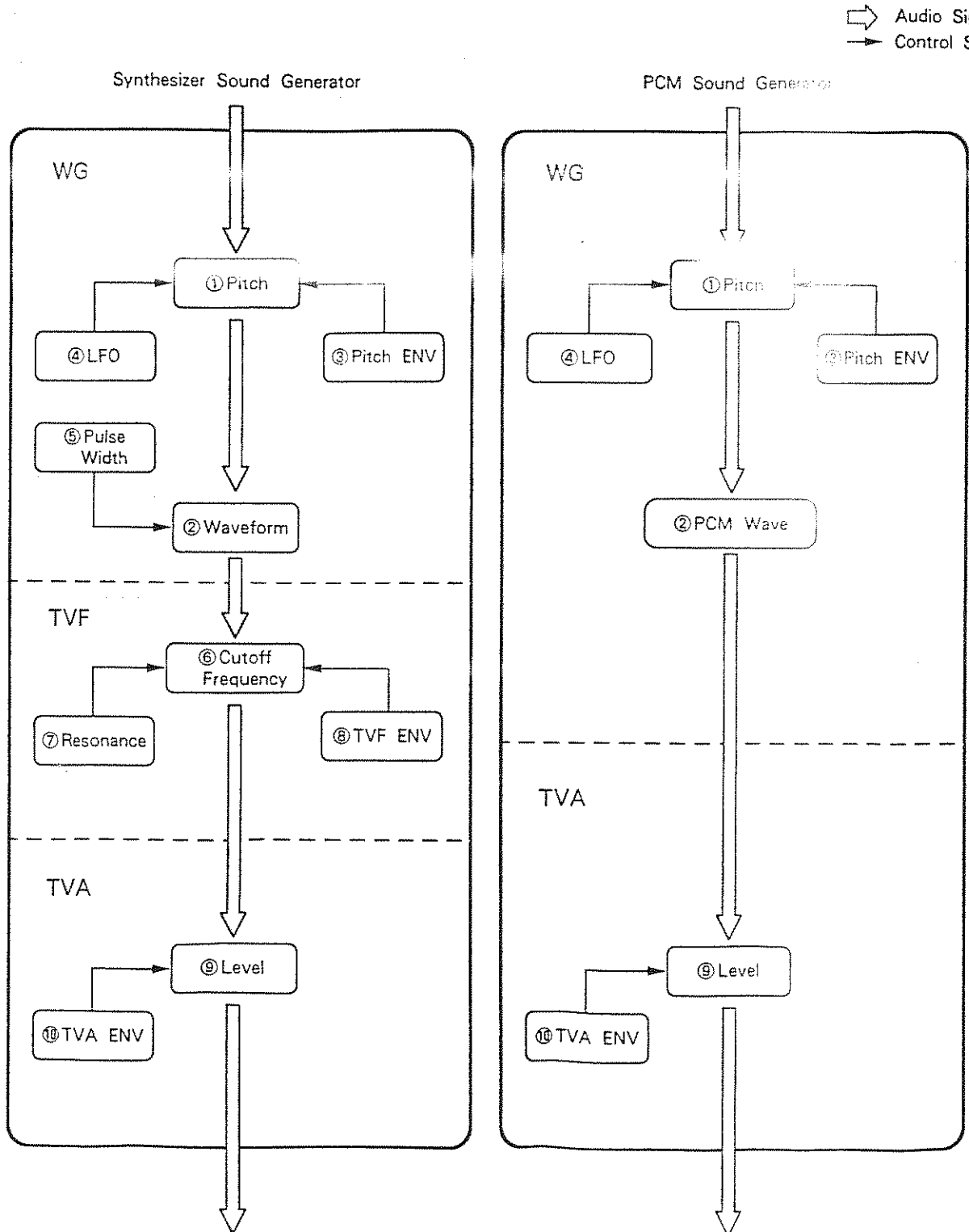

● **WG (Wave Generator)**

In the WG (Wave Generator), the pitch and wave form are controlled.

① **Pitch**

The basic pitch of a Partial (sound generator) at C4 key (=middle C) can be set here.

② **Waveform/PCM Wave Number**

This selects the waveform of the sound source.

③ **Pitch ENV**

This controls an envelope curve of the pitch changes caused by Key On/Off.

④ **LFO (Low Frequency Oscillator)**

LFO controls the vibrato.

⑤ **Pulse Width**

This changes the waveform of the sound source.

● **TVF (Time Variant Filter)**

This filter passes lower frequency harmonics and cuts off the higher ones. By changing the cutoff point and the resonance, the waveform changes.

⑥ **Cutoff Frequency**

This sets the cutoff point.

⑦ **Resonance**

This emphasizes the cutoff point, making more unusual or electronic sounds.

⑧ **TVF ENV**

This controls an envelope curve which changes the cutoff point, caused by Key On/Off.

● TVA (Time Variant Amplifier)

This controls the volume of the Partial.

⑨ Level

This determines the volume of the sound.

⑩ TVA ENV

This controls an envelope curve of the level changes caused by Key On/Off.

b. Editing Procedure

☐ For quicker and easier editing or synthesizing from scratch, the optional programmer PG-10 may be essential.

There are various groups of Tones. The Tones available for a Timbre or Patch differ depending on which memory, the internal memory or memory card, it belongs to.

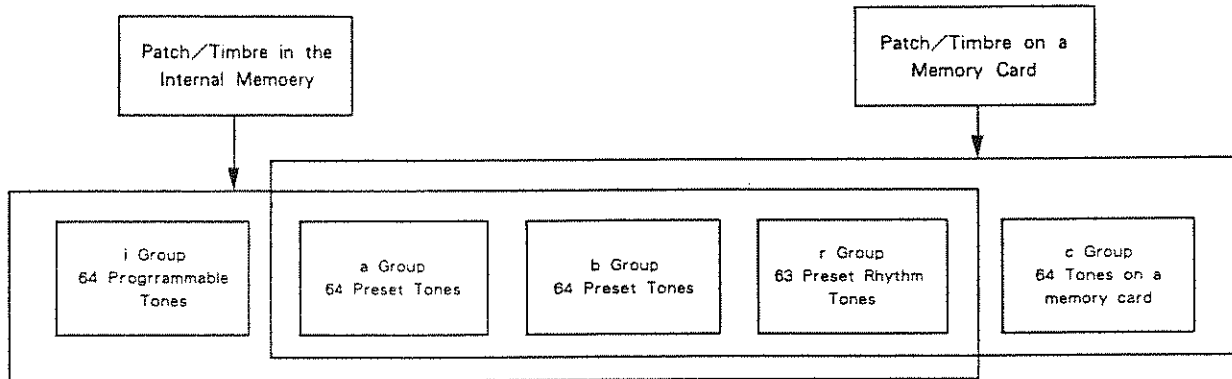

1) Editing Procedure

*The editing procedure does not automatically rewrite the existing data, the appropriate writing procedure on page 146 must be taken.

[Tone Selection]

Select a Tone which is similar to the sound you wish to make. The procedure for selecting a Tone differs in the Performance mode or Multi Timbral mode.

=Performance Mode=

Enter the Performance Play mode (The Performance and Synth Indicators light up), then do as follows.

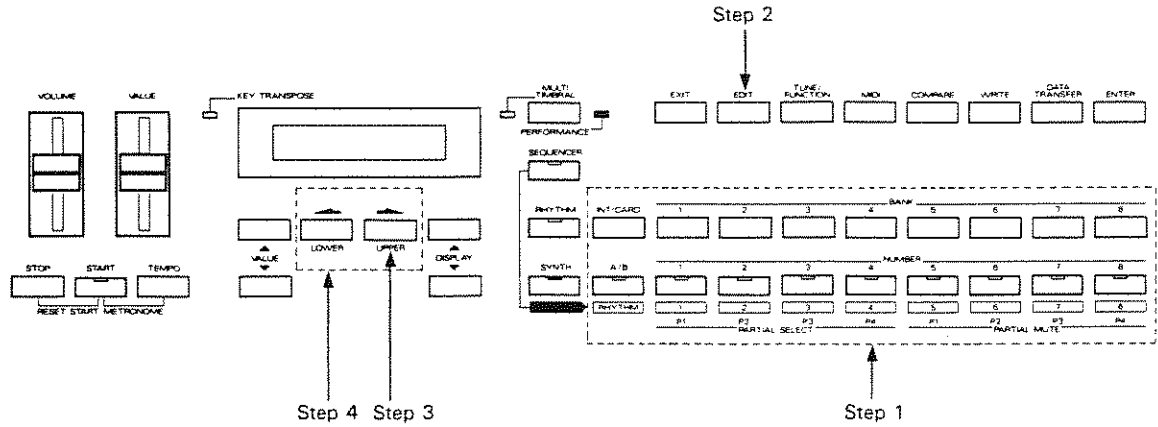

Step 1 Select a Patch that contains the Tone you want.

Step 2 Push the EDIT button.

```

Edit Select
Patch  Tone
    
```

Step 3 Push the right Cursor Button.

```

Edit Select
Lower  UPPER
    
```

Step 4 To edit the Lower Tone, push the left Cursor Button, and to edit the Upper Tone, the Cursor Button on the right.

```

Common
Select Parameter
    
```

Go to the following "Editing Tone Parameters".

= Multi Timbral Mode =

Take the following procedure in the Multi Timbral Play mode (=the Multi Timbral and Synth Indicators are lit.)

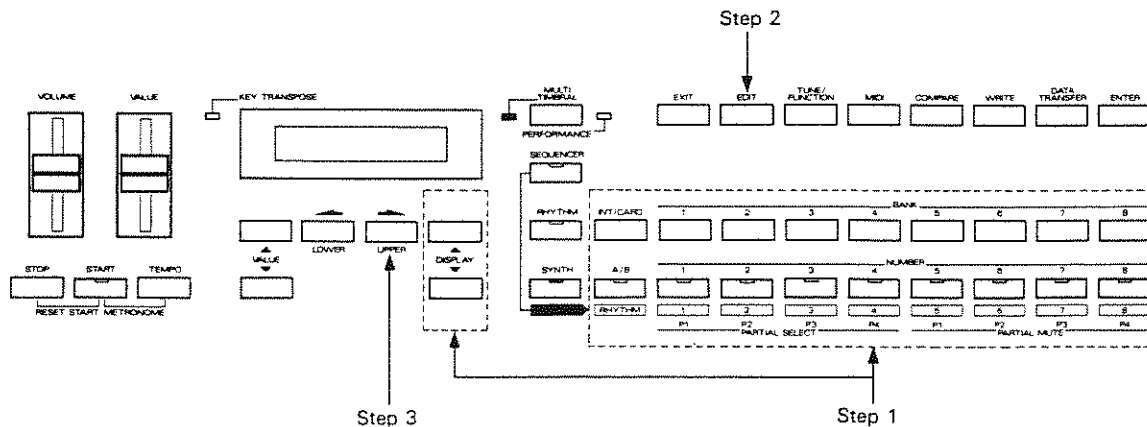

Step 1 Select a Timbre that contains the Tone you want.

To select a Timbre already assigned to any Part, use the relevant Part Display.

To select a Timbre which is not assigned to any Part, you can use any Part Display.

Step 2 Push the EDIT button.

```

Edit Select
Timbre Tone
    
```

Step 3 Push the right Cursor Button.

```

Common
Select Parameter
    
```

Go to the following "Editing Tone Parameters".

[Editing Tone Parameters]

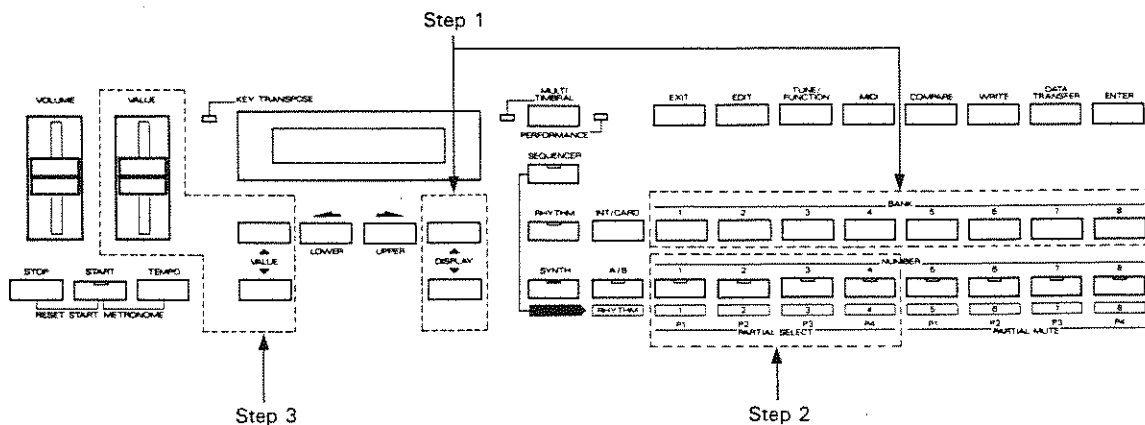

Step 1 Call the group that contains the parameter to be edited using the DISPLAY buttons, then select the parameter with the BANK button. (See the table below.)

Group	BANK							
	1	2	3	4	5	6	7	8
TVA ENV	Key Follow (Time)	Time 1	Time 2	Time 3	Time 4	Leve 1	Level 2	Sustain Level
TVA Level	Level	Velocity	Bias Point 1	Bias Level 1	Bias Point 2	Bias Level 2	ENV Velocity Follow (Time)	
TVF ENV	Key Follow (Time)	Tim 1	Time 2	Time 3	Time 4	Level 1	Level 2	Sustain Level
TVF Frequency	Cutoff Frequency	Resonance	Key Follow	Bias Point	Bias Level	ENV Depth	ENV Velocity	ENV Key Follow (Depth)
WG Pitch ENV	Time 1	Time 2	Time 3	Time 4	Level 0	Level 1	Level 2	End Level
WG Form/ Pitch ENV	Waveform	PCM Wave Bank	PCM Wave No.	Pulse Width	PW Velocity	ENV Depth	ENV Velocity	ENV Key Follow (Time)
WG Pitch/ Modulation	Pitch Coarse	Pitch Fine	Key Follow (Pitch)	LFO Rate	LFO Depth	LFO Modulation Sensivity	Bender Switch	
Common	Tone Name	Structure 1 & 2	Structure 3 & 4	ENV Mode				

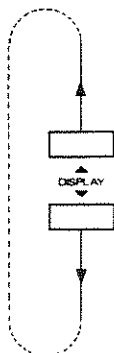

Step 2 The Partial's Display shows the values of four Partials at the same time. Select the value to be edited using the NUMBER buttons (1-4).

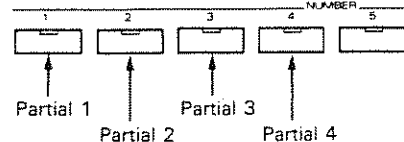
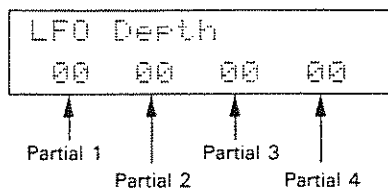

The corresponding Number Indicator will light up and the value you have selected (=flashing) can be now edited. It is possible to edit more than one Partial simultaneously by pressing different NUMBER buttons.

Step 3 **Change the value with the Value Control Knob.**

Step 4 **If you wish to write the edited value, take the appropriate writing procedure (page 146) immediately.**

***If you do not wish to write the edited value, push the EXIT button.**

2) Editing Functions

Various useful functions for editing are provided as follows.

[Partial Mute]

While editing a Partial parameter, any Partial sound can be muted, for you to listen to only the Partial you need.

The Partial Mute, which is also one of the Tone parameters, can be written into memory.

Simply push the relevant NUMBER buttons (5-8). The button indicator is muted when the corresponding Partial is muted.

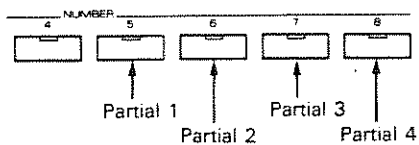

*Parameters of the Partial currently muted can be edited just the same.

*Muting one of the Partials used in the Ring Modulator will automatically output the other Partial which is not muted.

*Partial Mute decreases the number of Partials which are to be used, and therefore increases the number of voices.

[Previous Value]

"Previous Value" is the function that returns the current value of the parameter to the original value before being edited in the same Display.

<e.g.>

① Change to the LFO Display.

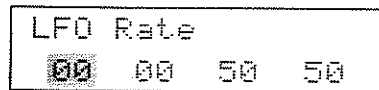

② Change the value of Partial 1 from 00 to 30.

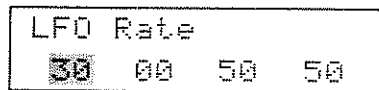

③ Push the COMPARE button.

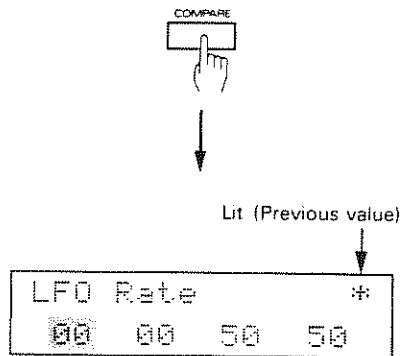

Now, the value before being edited (=00) is retrieved and played from the keyboard.

④ Push the COMPARE button to return to the edited value (sound).

*If you change the value or the setting of the Partial Select in the Previous Value Display, the * mark will disappear and the Previous Value mode is cancelled. This means that pressing the COMPARE button does not retrieve the edited value (=30).

[Compare]

While editing a parameter, you may wish to hear the original sound before it was edited. The Compare function allows you to call the original Tone without erasing the edited sound.

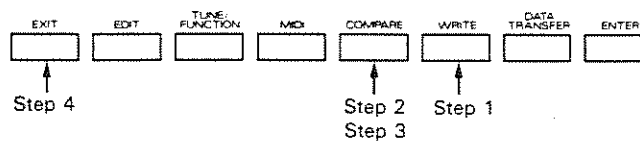

Step 1 Push the WRITE button.

Step 2 Push the COMPARE button.

The original sound can be heard by playing the keyboard.

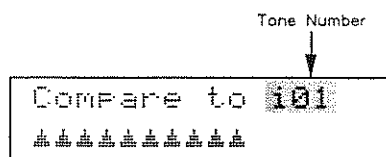

*If the source Tone you have been using is a Preset Tone, the Display does not show the Tone Number.

Step 3 Push the COMPARE button to return the edited Tone.

Step 4 Push the EXIT button.

Now, the unit is returned to the Tone Editing mode.

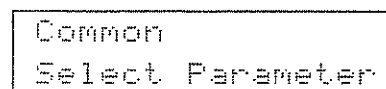

c. Tone Parameters

Some parameters included in a Partial that uses PCM sound generators are invalid. The following mark is shown when the parameters apply even for PCM sounds.

PCM

1) Common

● Tone Name **PCM**

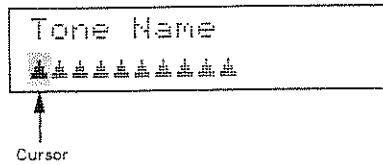

A Tone can be named using up to 10 letters. Move the cursor to the letter to be changed, then change letters with the Value Control Knob. The available letters for naming are as shown below.

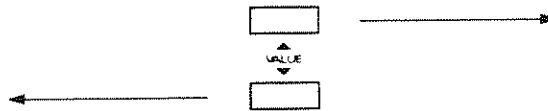

— A…Z, a…z, 0…9, & ≠ ! ? . , : ; ' " * + - / < = >
(Space)

Structure 1&2/3&4 **PCM**

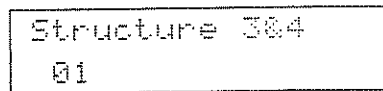
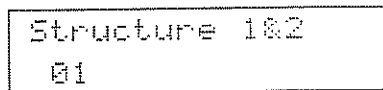

Select one of the following 13 Structures.

S (Synthesizer Sound Generator)
 P (PCM Sound Generator)

Structure Number	Partial 1	Partial 2	Combination of two Partials	Block Diagram
1	S	S	Mixture of Partial 1 (or 3) and Partial 2 (or 4).	
2	S	S	Mixture of Partial 1 (or 3) and ring-modulation.	
3	P	S	Mixture of Partial 1 (or 3) and Partial 2 (or 4).	
4	P	S	Mixture of Partial 1 (or 3) and ring-modulation.	
5	S	P	Mixture of Partial 1 (or 3) and ring-modulation.	
6	P	P	Mixture of Partial 1 (or 3) and Partial 2 (or 4).	
7	P	P	Mixture of Partial 1 (or 3) and ring-modulation.	
8	S	S	Partial 1 (or 3) and Partial 2 (or 4) are output in stereo.	
9	P	P	Partial 1 (or 3) and Partial 2 (or 4) are output in stereo.	
10	S	S	Partial 1 (or 3) and Partial 2 (or 4) are ring-modulated then output.	
11	P	S	Partial 1 (or 3) and Partial 2 (or 4) are ring-modulated then output.	
12	S	P	Partial 1 (or 3) and Partial 2 (or 4) are ring-modulated then output.	
13	P	P	Partial 1 (or 3) and Partial 2 (or 4) are ring-modulated then output.	

● ENV Mode **PCM**

ENV Mode
NORMAL

This selects whether to receive or ignore the Key Off messages in the ENV of each Partial. Normally, this should be set to NORMAL, but set to NO SUSTAIN for programming a Rhythm Tone.

[e.g.] TVF ENV/TVA ENV

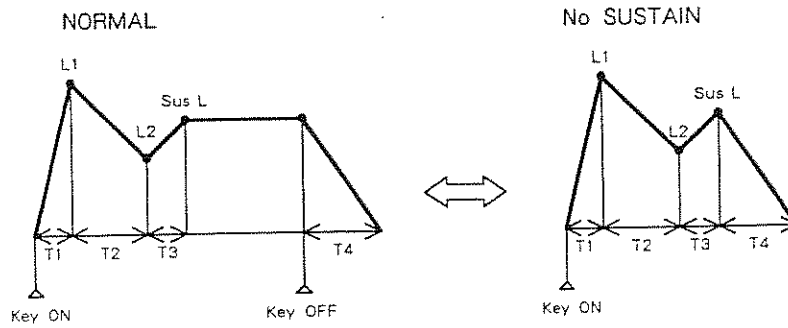

* When the ENV mode is NO SUSTAIN, the End Level of the Pitch ENV is played at the Point 3 Level.

* When using a non-Rhythm Tone as a rhythm tone, the ENV mode always changes to NO SUSTAIN no matter how it is set. (This applies to only when playing a rhythm tone with a rhythm pattern.)

2) WG Pitch/Modulation

● Pitch Coarse **PCM**

```
WG Pitch Coarse
C4  C4  C4  C4
```

This sets the standard pitch of a Partial in semi-tone steps from C1 to C9.

*The standard pitch is the pitch at C4 (middle C) key.

● Pitch Fine **PCM**

```
WG Pitch Fine
00  00  00  00
```

The standard pitch can be altered over about ± 50 cents from -50 to $+50$.

● Key Follow (Pitch) **PCM**

```
WG Pitch KF
1   1   1   1
```

Usually, the keyboard of a synthesizer assigns a semi-tone to each key. This Parameter can change the pitch ratio as shown below.

A value represents how many octaves are changed over 12 keys.

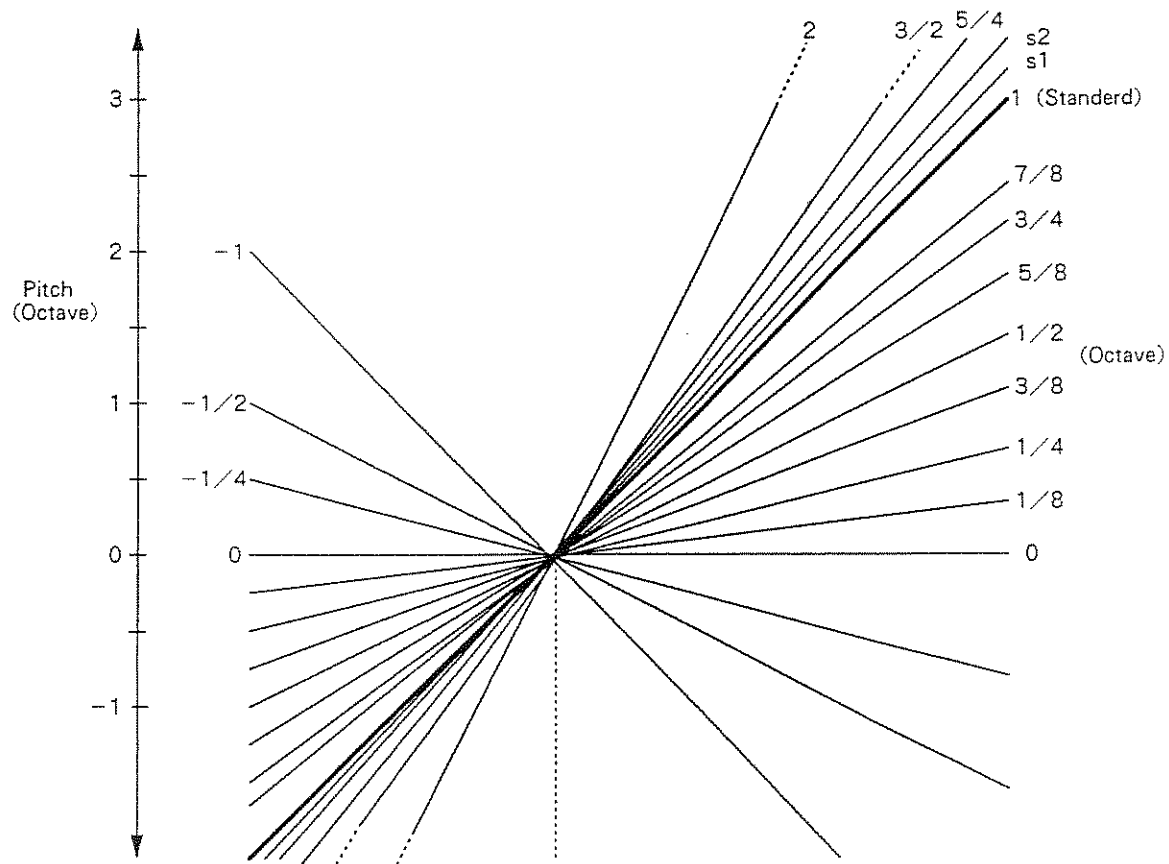

Middle C (C4)

*s1 or s2 may be selected for slightly stretching octaves. The "s" standing for special tuning.

s1 : Pitch 1 cent higher than one octave.

s2 : Pitch 5 cents higher than one octave.

● LFO Rate **PCM**

```
LFO Rate
 00 00 00 00
```

This sets the rate (frequency) of the LFO from 0 to 100. Higher values quicken the rate.

● LFO Depth **PCM**

```
LFO Depth
 00 00 00 00
```

This sets the depth of the LFO from 0 to 100. Higher values deepen the depth.

*Vibrate effect can be obtained only from Point 3 to Key Off of the Pitch ENV.

● Modulation Sensitivity **PCM**

```
WG Modulation
 00 00 00 00
```

This sets the sensitivity of the vibrato depth controlled by the bender lever from 0 to 100. Higher values deepen the effect.

*Vibrate effect can be obtained only from Point 3 to Key Off of the Pitch ENV.

● Bender Switch **PCM**

```
WG Bender Switch
ON ON ON ON
```

This selects whether to control the pitch by the bender lever or not.



3) WG Form/Pitch ENV

● Waveform **PCM**

```

WG Waveform
SQU SQU SQU SQU
    
```

This selects a waveform of the synthesizer sound generator.

Display	Waveform
SQU (Square)	
SAW (Sawtooth)	

*A sawtooth waveform is produced by processing a square waveform at the TVF, that is, even a sawtooth waveform can be controlled by Pulse Width.

● PCM Wave Bank/Number **PCM**

PCM Wave Bank

```

WG PCM Wave Bank
 1  1  1  1
    
```

PCM Wave Number

```

WG PCM Wave No.
01  01  01  01
    
```

This selects one of the 256 different sampled waves (128 waves in each Bank 1 or 2) of the PCM sound generator. Each sample is named (PCM name) as shown in the following table. A PCM name is shown in the PCM Wave Number Display when only one Partial is selected with the Partial Select parameter.

```

WG PCM Wave No.
1- 01: #####
    
```

↑ ↑ ↑
 Bank Number PCM Name

*For PCM sounds 112 to 128 in Bank 1, noise may be conspicuous during decay, depending on the setting of the TVA ENV.

Bank 1

No.	PCM Name	Remarks
1	Bass Drum-1	Rhythm Sound
2	Bass Drum-2	
3	Bass Drum-3	
4	Snare Drum-1	
5	Snare Drum-2	
6	Snare Drum-3	
7	Snare Drum-4	
8	Tom Tom-1	
9	Tom Tom-2	
10	High-Hat	
11	High-Hat (Loop)	
12	Crash Cymbal-1	
13	Crash Cymbal-2 (Loop)	
14	Ride Cymbal-1	
15	Ride Cymbal-2 (Loop)	
16	Cup	
17	China Cymbal-1	
18	China Cymbal-2 (Loop)	
19	Rim Shot	
20	Hand Clap	
21	Mute High Conga	
22	Conga	
23	Bongo	
24	Cowbell	
25	Tambourine	
26	Agogo	
27	Claves	
28	Timbale High	
29	Timbale Low	
30	Cabasa	
31	Timpani Attack	Attack Sound
32	Timpani	
33	Acoustic Piano High	
34	Acoustic Piano Low	
35	Piano Forte Thump	
36	Organ Percussion	
37	Trumpet	
38	Lips	
39	Trombone	
40	Clarinet	
41	Flute High	
42	Flute Low	
43	Steamer	
44	Indian Flute	
45	Breath	
46	Vibraphone High	
47	Vibraphone Low	
48	Marimba	
49	Xylophone High	
50	Xylophone Low	
51	Kalimba	
52	Wind Bell	
53	Chime Bar	
54	Hammer	
55	Guio	
56	Chink	
57	Nails	
58	Fretless Bass	
59	Pull Bass	
60	Slap Bass	
61	Thump Bass	
62	Acoustic Bass	
63	Electric Bass	
64	Gut Guitar	

No.	PCM Name	Remarks	
65	Steel Guitar		
66	Dirty Guitar		
67	Pizzicato		
68	Harp		
69	Contrabass		
70	Cello		
71	Violin-1		
72	Violin-2		
73	Koto		
74	Draw bars (Loop)		Sustained Sound
75	High Organ (Loop)		
76	Low Organ (Loop)		
77	Trumpet (Loop)		
78	Trombone (Loop)		
79	Sax-1 (Loop)		
80	Sax-2 (Loop)		
81	Reed (Loop)		
82	Slap Bass (Loop)		
83	Acoustic Bass (Loop)		
84	Electric Bass-1 (Loop)		
85	Electric Bass-2 (Loop)		
86	Gut Guitar (Loop)		
87	Steel Guitar (Loop)		
88	Electric Guitar (Loop)		
89	Clav (Loop)		
90	Cello (Loop)		
91	Violin (Loop)		
92	Electric Piano-1 (Loop)		
93	Electric Piano-2 (Loop)		
94	Harpsichord-1 (Loop)		
95	Harpsichord-2 (Loop)		
96	Telephone Bell (Loop)		
97	Female Voice-1 (Loop)		
98	Female Voice-2 (Loop)		
99	Male Voice-1 (Loop)		
100	Male Voice-2 (Loop)		
101	Spectrum-1 (Loop)		
102	Spectrum-2 (Loop)		
103	Spectrum-3 (Loop)		
104	Spectrum-4 (Loop)		
105	Spectrum-5 (Loop)		
106	Spectrum-6 (Loop)		
107	Spectrum-7 (Loop)		
108	Spectrum-8 (Loop)		
109	Spectrum-9 (Loop)		
110	Spectrum-10 (Loop)		
111	Noise (Loop)		
112	Shot-1	Decay Sound	
113	Shot-2		
114	Shot-3		
115	Shot-4		
116	Shot-5		
117	Shot-6		
118	Shot-7		
119	Shot-8		
120	Shot-9		
121	Shot-10		
122	Shot-11		
123	Shot-12		
124	Shot-13		
125	Shot-14		
126	Shot-15		
127	Shot-16		
128	Shot-17		

Bank 2

No.	PCM Name	Remarks	No.	PCM Name	Remarks
1	Bass Drum-1*	Rhythm Sound (The Master Tune does not affect the pitch.)	65	Loop-35	
2	Bass Drum-2*		66	Loop-36	
3	Bass Drum-3*		67	Loop-37	
4	Snare Drum-1*		68	Loop-38	
5	Snare Drum-2*		69	Loop-39	
6	Snare Drum-3*		70	Loop-40	
7	Snare Drum-4*		71	Loop-41	
8	Tom Tom-1*		72	Loop-42	
9	Tom Tom-2*		73	Loop-43	
10	High-Hat*		74	Loop-44	
11	High-Hat* (Loop)		75	Loop-45	
12	Crash Cymbal-1*		76	Loop-46	
13	Crash Cymbal-2* (Loop)		77	Loop-47	
14	Ride Cymbal-1*		78	Loop-48	
15	Ride Cymbal-2* (Loop)		79	Loop-49	
16	Cup*		80	Loop-50	
17	China Cymbal-1*		81	Loop-51	
18	China Cymbal-2* (Loop)		82	Loop-52	
19	Rim Shot*		83	Loop-53	
20	Hand Clap*		84	Loop-54	
21	Mute High Conga*		85	Loop-55	
22	Conga*		86	Loop-56	
23	Bongo*		87	Loop-57	
24	Cowbell*		88	Loop-58	
25	Tambourine*		89	Loop-59	
26	Agogo*		90	Loop-60	
27	Claves*		91	Loop-61	
28	Timbale High*		92	Loop-62	
29	Timbale Low*		93	Loop-63	
30	Cabasa*		94	Loop-64	
31	Loop-1	Effect Sound (The same sound is repeated.)	95	Jam-1 (Loop)	Effect Sound (A combination of several sounds is repeated.)
32	Loop-2		96	Jam-2 (Loop)	
33	Loop-3		97	Jam-3 (Loop)	
34	Loop-4		98	Jam-4 (Loop)	
35	Loop-5		99	Jam-5 (Loop)	
36	Loop-6		100	Jam-6 (Loop)	
37	Loop-7		101	Jam-7 (Loop)	
38	Loop-8		102	Jam-8 (Loop)	
39	Loop-9		103	Jam-9 (Loop)	
40	Loop-10		104	Jam-10 (Loop)	
41	Loop-11		105	Jam-11 (Loop)	
42	Loop-12		106	Jam-12 (Loop)	
43	Loop-13		107	Jam-13 (Loop)	
44	Loop-14		108	Jam-14 (Loop)	
45	Loop-15		109	Jam-15 (Loop)	
46	Loop-16		110	Jam-16 (Loop)	
47	Loop-17		111	Jam-17 (Loop)	
48	Loop-18		112	Jam-18 (Loop)	
49	Loop-19		113	Jam-19 (Loop)	
50	Loop-20		114	Jam-20 (Loop)	
51	Loop-21		115	Jam-21 (Loop)	
52	Loop-22		116	Jam-22 (Loop)	
53	Loop-23		117	Jam-23 (Loop)	
54	Loop-24		118	Jam-24 (Loop)	
55	Loop-25		119	Jam-25 (Loop)	
56	Loop-26		120	Jam-26 (Loop)	
57	Loop-27		121	Jam-27 (Loop)	
58	Loop-28		122	Jam-28 (Loop)	
59	Loop-29		123	Jam-29 (Loop)	
60	Loop-30		124	Jam-30 (Loop)	
61	Loop-31		125	Jam-31 (Loop)	
62	Loop-32		126	Jam-32 (Loop)	
63	Loop-33		127	Jam-33 (Loop)	
64	Loop-34		128	Jam-34 (Loop)	

● Pulse Width

```

WG Pulse Width
 50  50  50  50
    
```

A square waveform has exactly the same width, vertically and horizontally, but a Pulse Width waveform has different widths. The ratio of upper width to lower is called pulse width, 0 to 100 are valid for setting the pulse width. Depending on the set pulse width value, the harmonic content of the sound changes greatly.

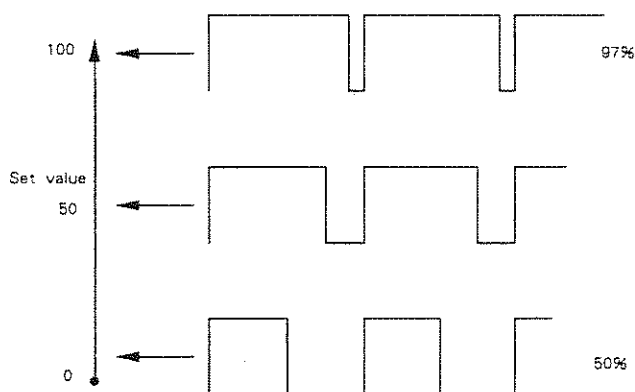

*When a sawtooth is selected with the WG Waveform parameter, pulse width 50% raises the pitch by an octave.

● Pulse Width Velocity Sensitivity

```

WG PW Velocity
 00  00  00  00
    
```

This sets the sensitivity of the velocity that controls the pulse width from -7 to +7. With "-" values, the pulse width becomes smaller by playing the keyboard harder, and with "+" values, the pulse width becomes wider by playing the keyboard harder.

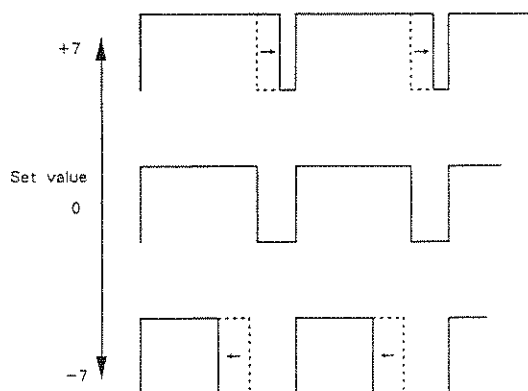

● Pitch ENV Depth

PCM

```
P-ENV Depth
05 05 05 05
```

This sets the depth of the Pitch ENV from 1 to 10. Higher values deepen the effect.

● Pitch ENV Velocity Sensitivity

PCM

```
P-ENV Velocity
02 02 02 02
```

This sets the maximum effect of the velocity that controls the pitch of the Pitch ENV from 0 to 3. At higher values, the keyboard velocity has a greater effect on the envelope.

● Pitch ENV Key Follow (Time)

PCM

```
P-ENV Time KF
00 00 00 00
```

This sets the time of the Pitch ENV depending on the key played, from 0 to 4. Higher values change the time more drastically.

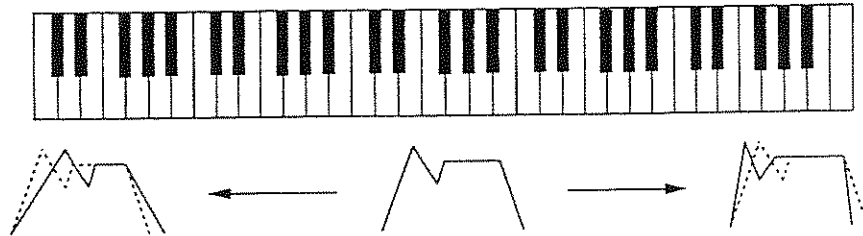

4) Pitch ENV

● Pitch ENV Time/Level

PCM

These parameters are the time needed for a pitch curve to move from one point to another, and the pitch level of a certain point.

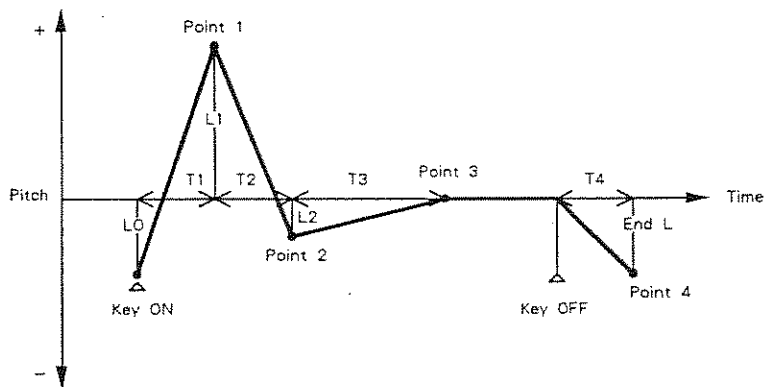

Time 1/Time 2/Time 3/ Time 4

P-ENV Time 1
50 50 50 50

P-ENV Time 2
50 50 50 50

P-ENV Time 3
50 50 50 50

P-ENV Time 4
50 50 50 50

This sets the time needed from one point to another, from 0 to 100.

Level 0/Level 1/Level 2/End Level

```
P-ENV Level 0  
00 00 00 00
```

```
P-ENV Level 1  
00 00 00 00
```

```
P-ENV Level 2  
00 00 00 00
```

```
P-ENV End Level  
00 00 00 00
```

*When the ENV mode is NO SUSTAIN, the End Level of the Pitch ENV is played at the Point 3 Level.

This sets the pitch of a certain point from -50 to+50.

*If the level of two adjacent points are set to similar values, the time between these two points may prove to be shorter than what is actually set, or even zero.

5) TVF Frequency/ENV

● Cutoff Frequency

```

TVF Cutoff Freq
100 100 100 100
    
```

This sets the cutoff point of the TVF from 0 to 100. As you lower the value, higher frequencies are removed and the waveform gradually become an approximation of a sine wave, then the sound will finally fade out.

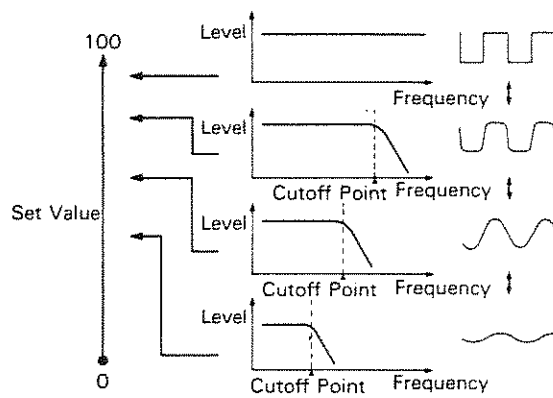

● Resonance

```

TVF Resonance
00 00 00 00
    
```

This boosts the cutoff point from 0 to 30. As you increase the value, specific harmonics are emphasized and the sound will become more unusual, more electronic in nature.

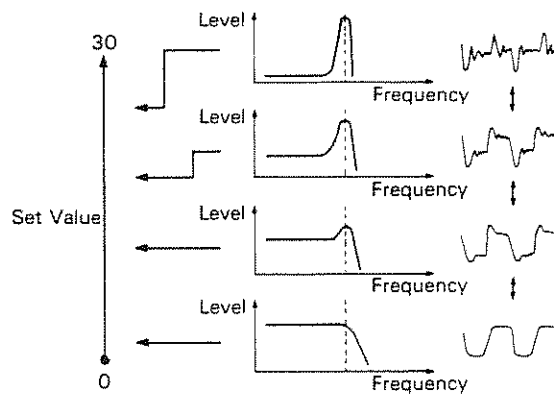

● Key Follow (Frequency)

```
TUF Freq KF  
1/2 1/2 1/2 1/2
```

This can change the cutoff point depending on the key played.

Just like the Key Follow of WG Pitch, the value represents how many octaves change over 12 keys.

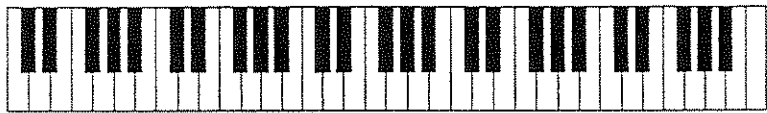
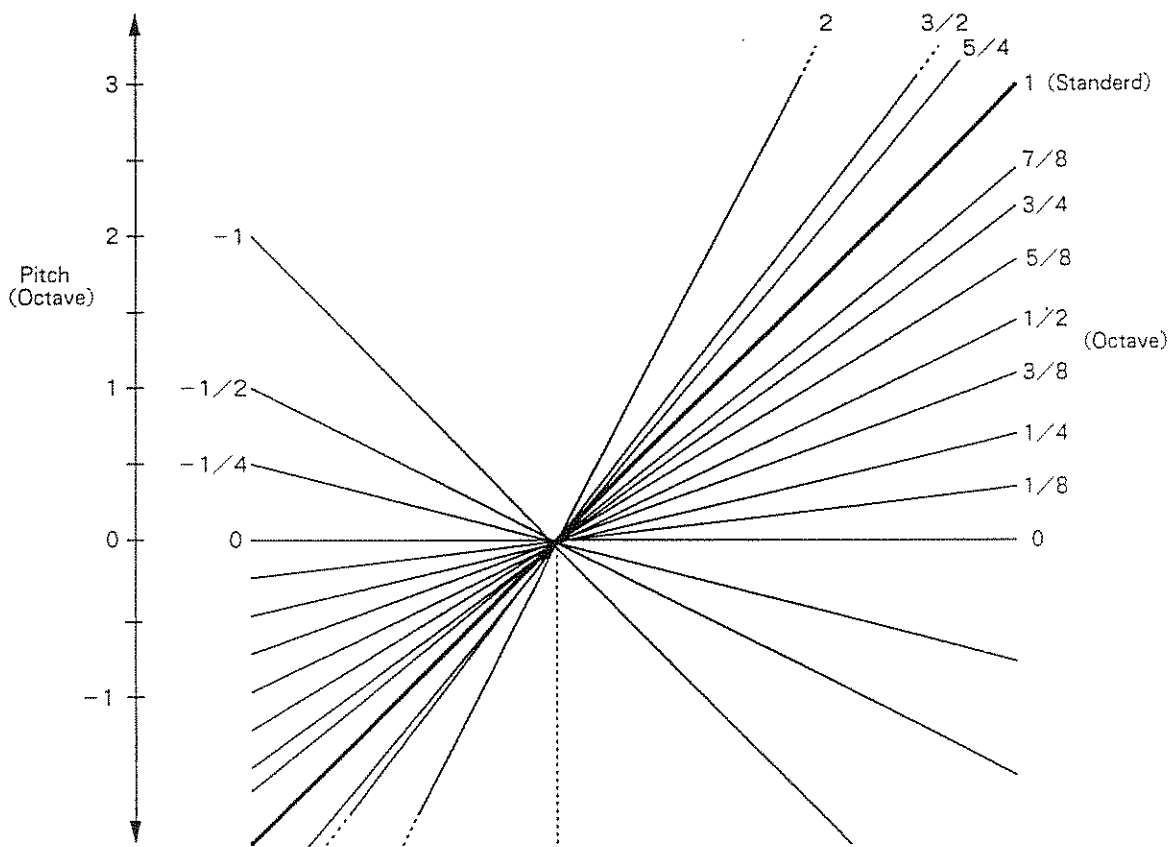

Middle C (C4)

● Bias Point/Level

You can add a further change (=bias level) to the Key Follow curve from any point (key).

Bias Point

```
TUF Bias Point
<C4 <C4 <C4 <C4
```

This sets the range (point and direction) where the bias level is valid, from <A1 to <C7 and from >A1 to >C7 in semi-tone steps.

[e.g.] >C4 : The bias level is valid on the keyboard above the C4 key.
 <C4 : The bias level is valid on the keyboard below the C4 key.

Bias Level

```
TUF Bias Level
00 00 00 00
```

This bias level can be set from -7 to +7. "+" values raise the curve, and "-" values lower the curve.

[Example]

When set to TVF Key Follow (Cutoff Point) "0"
 and Bias Point ">C4".

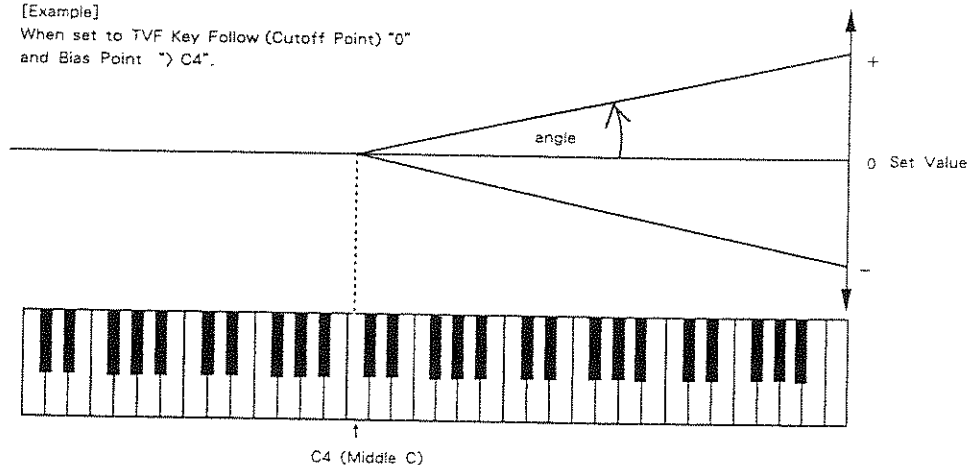

*The curve shown in the picture represents the Key Follow value with the Bias Level added.

● ENV Depth

```
TVF ENV Depth
50 50 50 50
```

This sets the depth of the TVF ENV modulation that changes the TVF Cutoff point. 0 to 100 are valid. At higher values the effect is deeper.

● ENV Velocity Sensitivity

```
TVF ENV Velocity
50 50 50 50
```

This sets the sensitivity of the velocity that controls the depth of the TVF ENV. 0 to 100 are valid. At higher values, the effect is deeper by playing the keyboard harder.

● ENV Key Follow (Depth)

```
TVF ENV Depth KF
00 00 00 00
```

This can change the TVF ENV depth depending on the key played. 0 to 4 are valid, higher values change the depth more drastically.

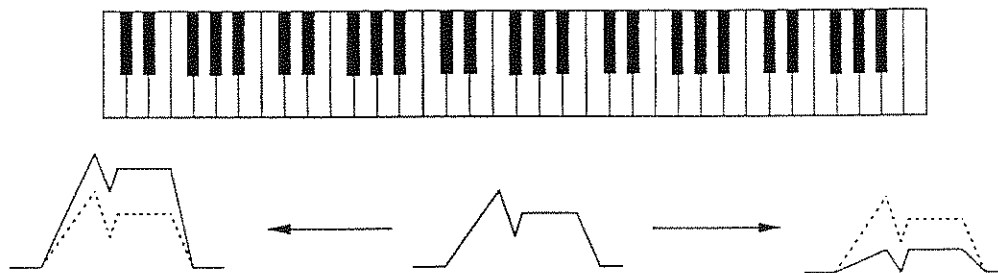

6) TVF ENV

● ENV Key Follow (Time)

TUF	ENV	Time	KF
00	00	00	00

This can change the time of the TVF ENV depending on the key played. 0 to 4 are valid, higher values changing the time more drastically.

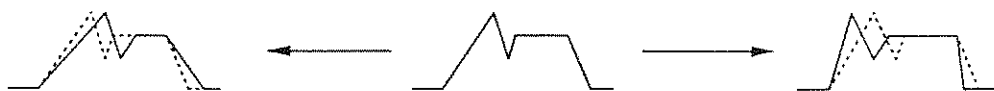

● ENV Time/Level

These parameters are the time needed for the envelope curve of cutoff frequencies to move from one point to another, and the level of the cutoff frequencies at a certain point.

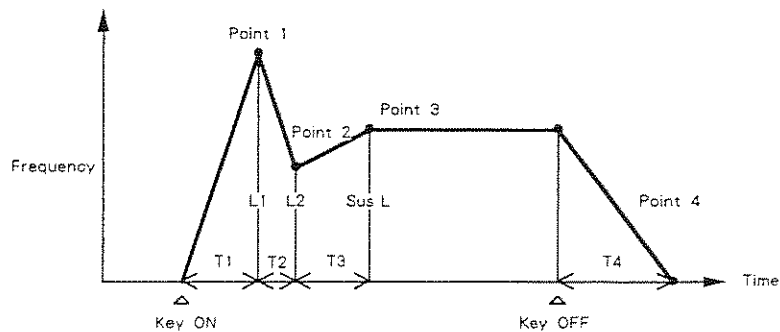

Time 1/Time 2/Time 3/ Time 4

```
TUF ENU Time 1
50 50 50 50
```

```
TUF ENU Time 2
50 50 50 50
```

```
TUF ENU Time 3
50 50 50 50
```

```
TUF ENU Time 4
50 50 50 50
```

This sets the time needed from one point to another, from 0 to 100.

Level 0/Level 1/Level 2/End Level

```
TUF ENU Level 1
50 50 50 50
```

```
TUF ENU Level 2
50 50 50 50
```

```
TUF ENU Sus Lev1
50 50 50 50
```

This sets the level of a certain point from -50 to+50.

*If the level of two adjacent points are set to similar values, the time between these two points may prove to be shorter than what is actually set, or even zero.

7) TVA Level

● Level **PCM**

```
TVA Level
50 50 50 50
```

This sets the volume of a Partial from 0 to 100.

*Higher values may cause sound distortion. If so, lower the value.

*Even when this is set to zero here, the sound may not be completely muted if the TVA ENV curve is high.

● Velocity Sensitivity **PCM**

```
TVA Velocity
00 00 00 00
```

This sets the sensitivity of the velocity that controls the volume of the sound from -50 to +50. "-" values lower the level by harder playing, and "+" values raise the level by harder playing.

● Bias Point/Level **PCM**

You can add a further change (=bias level) to the volume level from any point (key).

Bias Point

```
TVA Bias Point 1
<C4 <C4 <C4 <C4
```

```
TVA Bias Point 2
<C4 <C4 <C4 <C4
```

This sets the range (point and direction) where the bias level is valid at two positions (keys), from <A1 to <C7 and from >A1 to >C7 in semi-tone steps.

[e.g.] >C4 : The bias level is valid on the keyboard above the C4 key.
<C4 : The bias level is valid on the keyboard below the C4 key.

Bias Level

```
TVA Bias Level 1  
00 00 00 00
```

```
TVA Bias Level 2  
00 00 00 00
```

This bias level can be set from 0 to -12. Lower values lower the curve.

[Example]
When set the Bias Point 1 to "<C3" and
the Bias Point 2 to "<C6".

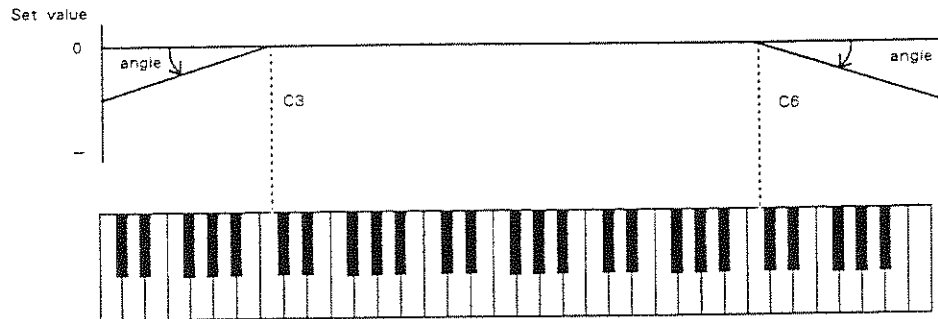

● ENV Velocity Follow (Time 1)

PCM

TVA	ENV	T1	Velc
00	00	00	00

This sets the maximum effect of the velocity that controls the time of the TVA ENV from 0 to 4. At higher values, Time 1 will be shortened by playing the keyboard harder.

8) TVA ENV

● ENV Key Follow (Time)

PCM

TVA	ENV	Time	KF
00	00	00	00

This sets the time of the TVA ENV depending on the key played, from 0 to 4. Higher values change the time more drastically.

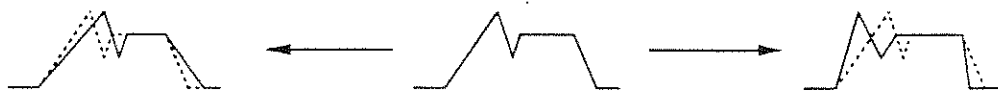

● ENV Time/Level

PCM

These parameters are the time needed for a volume curve to move from one point to another, and the volume of a certain point.

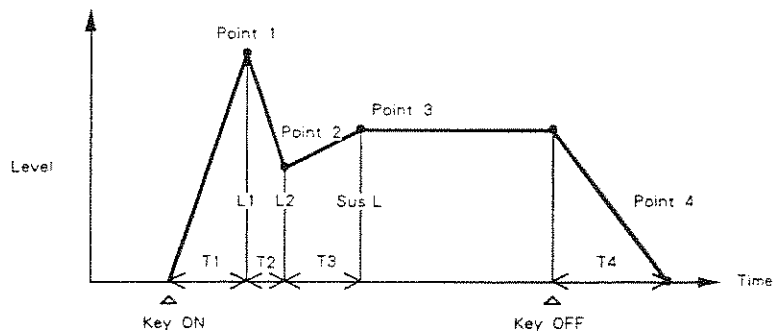

d. Writing Procedure

The edited data does not rewrite the previous data, and therefore will be erased when a different Tone is selected or the unit is turned off. To retain the edited data, take the following writing procedure, either into the internal memory or onto a memory card (M-256D, M-256E).

*Writing a new Tone will replace the corresponding Tone in each Patch and Timbre, therefore, the sound will change.

1) Writing into the internal memory

To write the edited Tone into a location in the internal memory, do as follows.

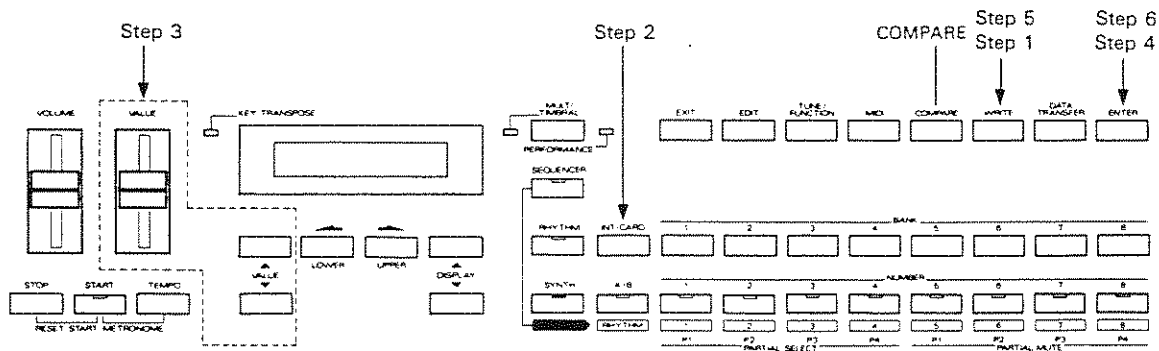

Step 1 Push the WRITE button.

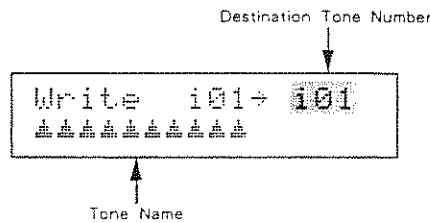

*When you have edited a Preset Tone, the destination Tone number is not indicated.

Step 2 If you have edited a Tone on a memory card, select " i " by pushing the INT/CARD button.

Step 3 To change the destination Tone number, use the Value Control Knob.

If you wish to listen to the destination Tone before rewriting it, do as follows.

① Push the COMPARE button.

```
Compare to 101
▲▲▲▲▲▲▲▲▲▲▲▲
```

② Select the destination Tone using the Value Control Knob.

Now, the destination Tone can be heard by playing the keyboard.

③ Push the COMPARE button to return to the previous Display.

Step 4 Push the ENTER button.

```
Turn Protect off
once? Write/Exit
```

Step 5 Push the WRITE button.

The Memory Protect is released, and the Display returns to that of Step 3.

Step 6 Push the ENTER button.

When writing is completed, the Display responds as shown below, then returns to the Play Mode Display.

```
Complete
```

*If the writing procedure is not properly completed, the Display shows an Error Message. If this happens, resolve it as explained on page 212 "Error Messages".

2) Writing onto a memory card

*When using a brand new memory card, be sure to copy the entire data in the internal memory onto the card as explained on page 189 "Saving".

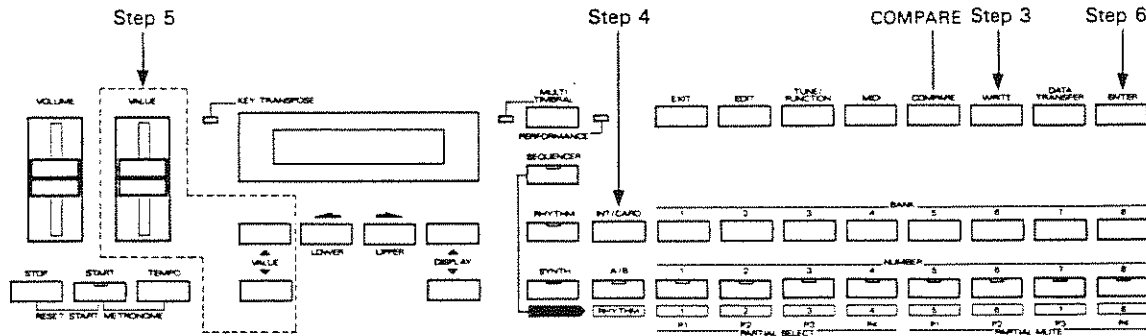

Step 1 Insert a memory card into the Card Slot.

Step 2 Set the Protect Switch on the memory card to OFF.

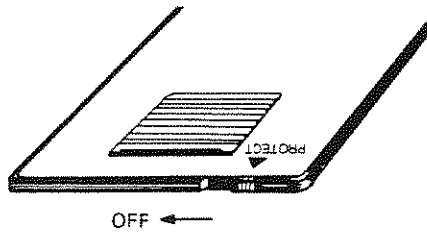

Step 3 Push the WRITE button.

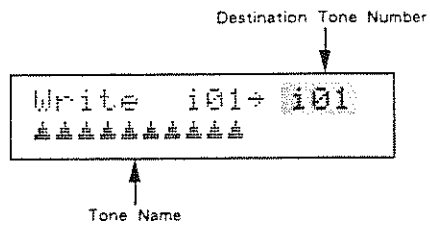

*When you have edited a Preset Tone, the destination Tone number is not indicated.

Step 4 If you have edited a Tone in the internal memory, select "c" by pushing the INT/CARD button.

Step 5 To change the destination Tone number, use the Value Control Knob.

If you wish to listen to the destination Tone before rewriting it, do as follows.

① Push the COMPARE button.

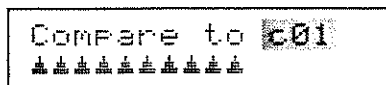

② Select the destination Tone using the Value Control Knob.

Now, the destination Tone can be heard by playing the keyboard.

③ Push the COMPARE button to return to the previous Display.

Step 6 Push the ENTER button.

When writing is completed, the Display responds as shown below, then returns to the Play Mode Display.

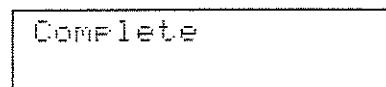

*If the writing procedure is not properly completed, the Display shows an Error Message. If this happens, resolve it as explained on page 212 "Error Messages".

Step 7 Set the Protect Switch on the memory card back to the ON position.

4 APPLICATIONS OF THE D-20

1. Performance Mode

This sections describes how to use the built-in Sequencer in the Performance Mode, and MIDI devices.

a. Using the Sequencer

1) Structure of the Sequencer

The following diagram shows how performance messages run in the Performance mode.

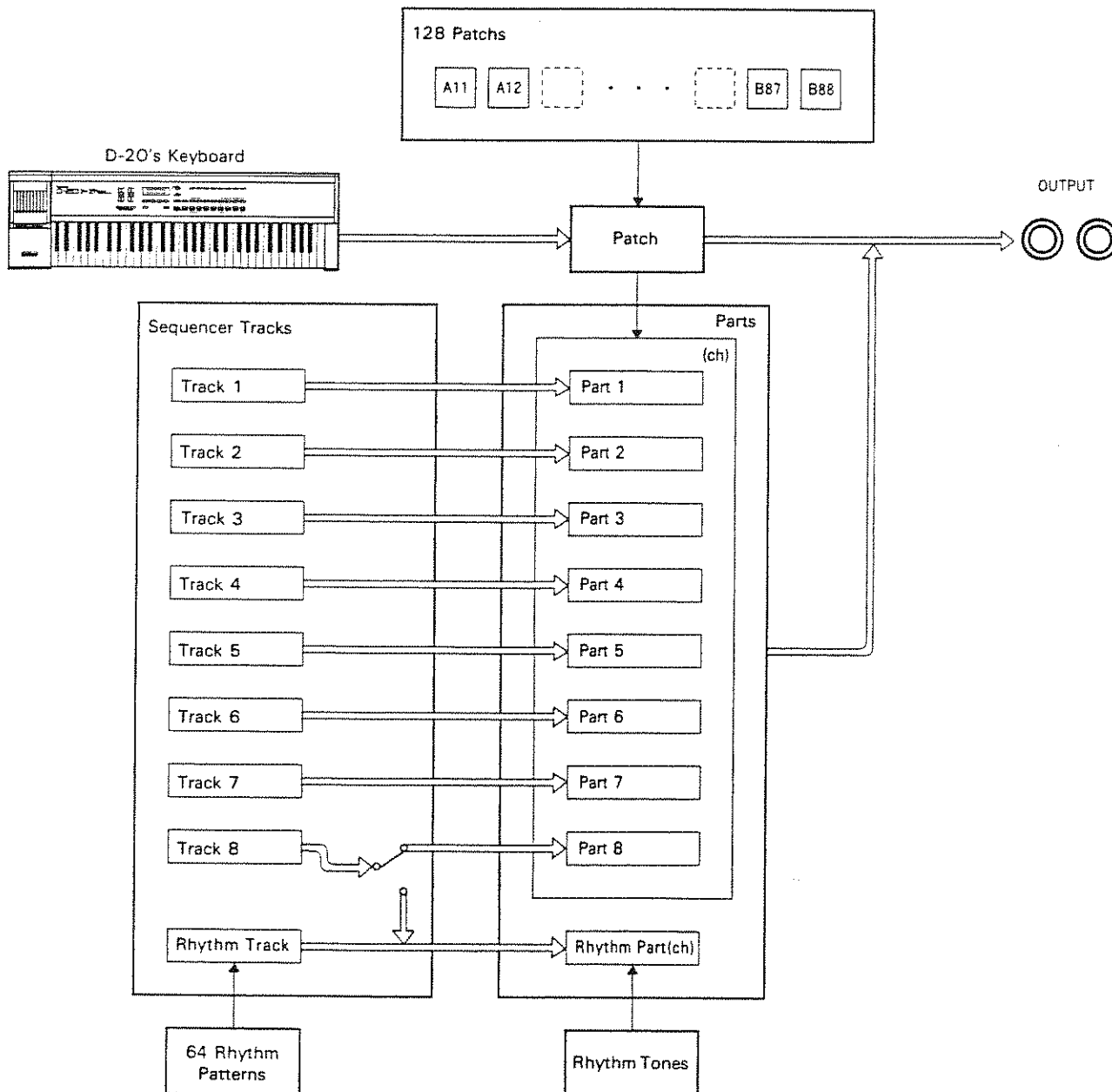

[Part]

Each of the 9 Parts can be used as an independent MIDI sound module. However, in the Performance mode, the same Patch is assigned to Parts 1 to 8, in other words, all these 8 modules are the exactly the same.

[Sequencer]

The D-20's sequencer features 9 Tracks for recording your performance data, each Track playing the corresponding Part with the recorded performance data. Track 8 can be used as a rhythm track for recording rhythm a performance in real time.

● Track Mute

The Sequencer is provided with a Track Mute function that can mute the Track you select. The performance data of the muted Track is transmitted through the MIDI OUT, therefore, can play an external MIDI device.

*The Bender, Modulation, Volume, Hold and Program Change messages recorded in the muted Track is transmitted in every MIDI function.

2) How to use the Sequencer

In the Performance mode, the same Patch is assigned to all the 8 Parts. This means that it is of no use to play more than one Track using only this unit. When using the Sequencer in the Performance mode, use only one of the Tracks 1 to 8, and the Rhythm Track, muting all the other Tracks.

In the Performance Mode, you may use the Sequencer as shown below.

☐ Using the Rhythm Track

Play the keyboard to the rhythm performance recorded in the Rhythm Track or Track 8.

☐ Easy Recording

You may record a short phrase in the Sequencer, like a memo.

☐ Using another MIDI sound module

Using the fact that the muted Track's performance data is transmitted through the MIDI OUT, you can create ensemble effects with the D-20 and a MIDI sound module.

(See the next chapter "Using MIDI Devices".)

b. Using MIDI Devices

1) How MIDI Messages run

The following diagram shows how performance messages run in the Performance mode.

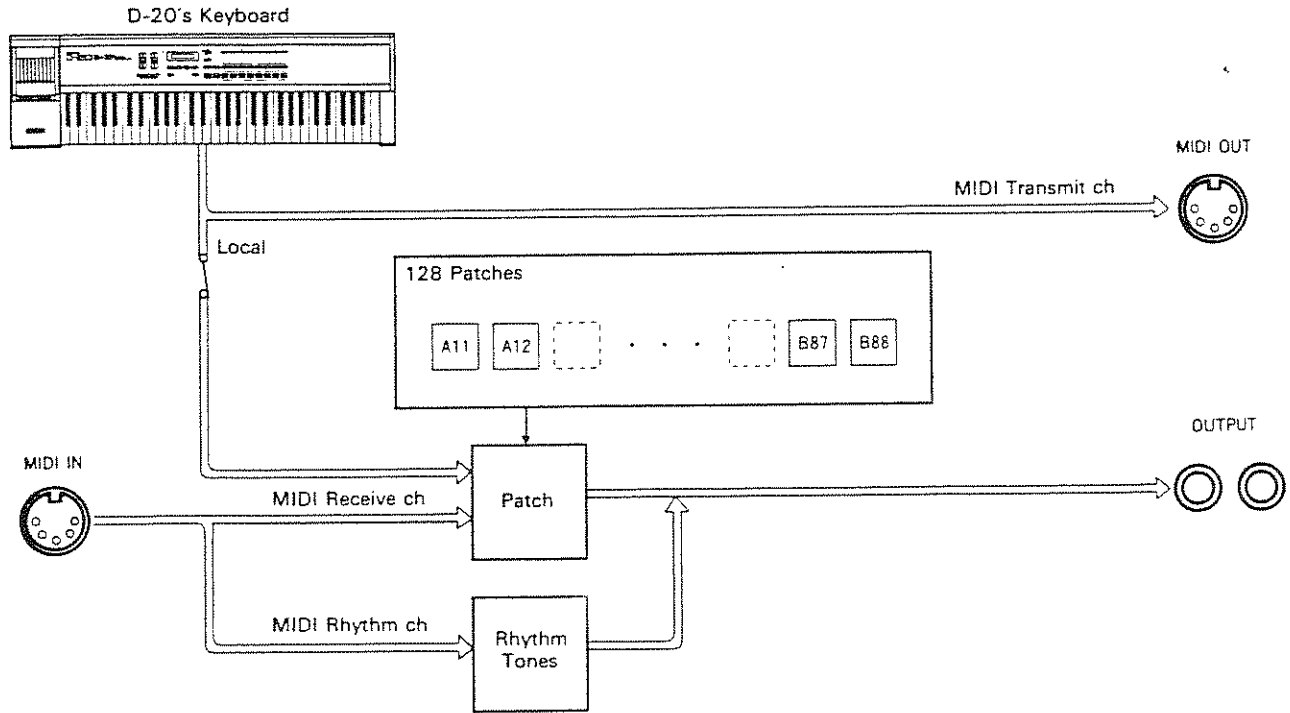

<Sequencer's Performance Data>
Sequencer

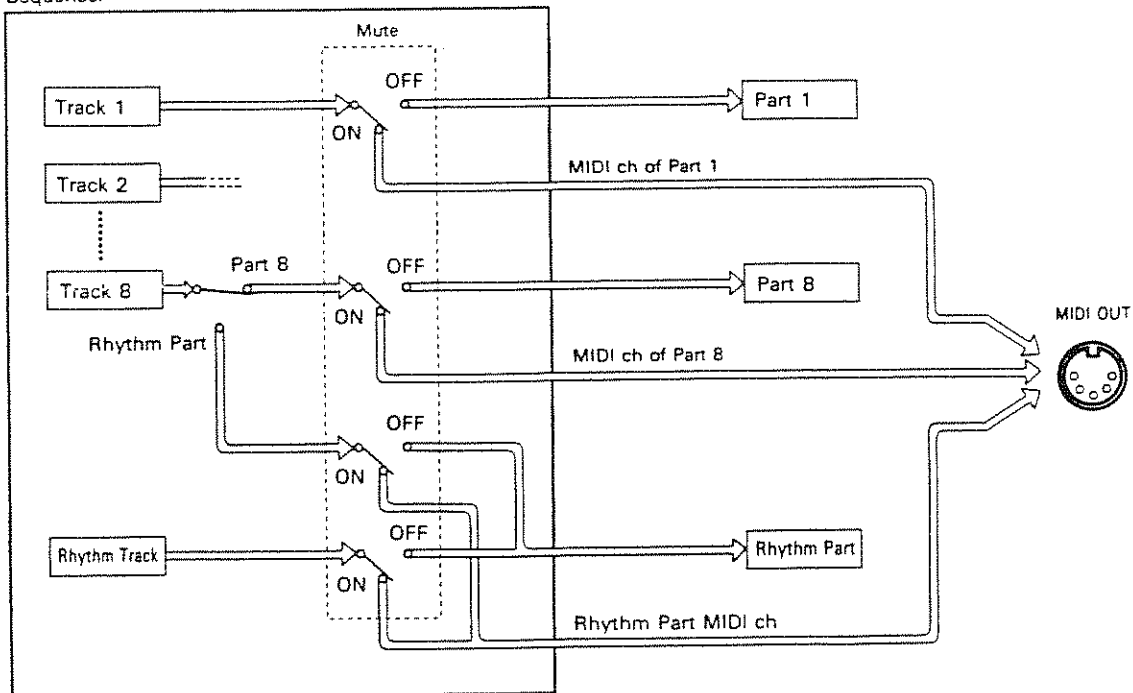

- The keyboard's performance messages are sent through MIDI OUT on the set MIDI transmit channel.
- Performance messages received on a MIDI receive channel play the synthesizer sound module, and those received on the MIDI Rhythm channel play Rhythm sounds.
- Regarding performance data in the Sequencer, only the performance data of the muted Tracks are transmitted from the MIDI OUT (on the MIDI channel of the relevant Parts respectively).

[Using the D-20 as a MIDI sound module]

- Playing the rhythm sounds of the D-20 by using a programmable rhythm machine.

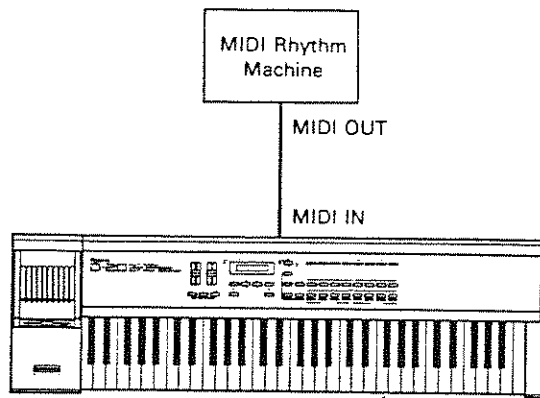

Channel Setting Example:
 D-20 Rhythm Machine
 Rhythm Channel
 Channel ch10 ← ch10

- Playing the sound source of the D-20 by using a MIDI sequencer.

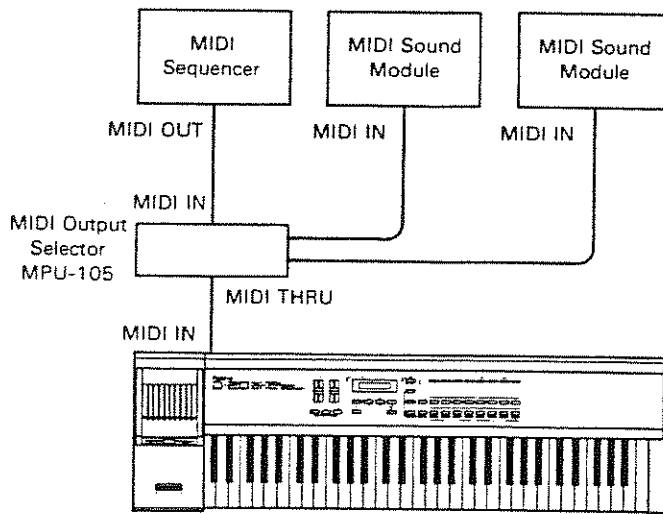

Channel Setting Example:
 D-20 Sequencer
 Receive Performance Data
 Channel ch1 ← ch1
 Rhythm Rhythm
 Channel ch10 ← Performance Data ch10

3) MIDI Function Setting

This section describes how to set the MIDI functions in the Performance mode.

First, make sure that the Performance Indicator is lit, then do as follows.

*The edited value will be retained in memory except for a few functions.

*For setting MIDI channels in each Part, see the next chapter "MIDI Channel Setting for each Part".

[Editing Procedure]

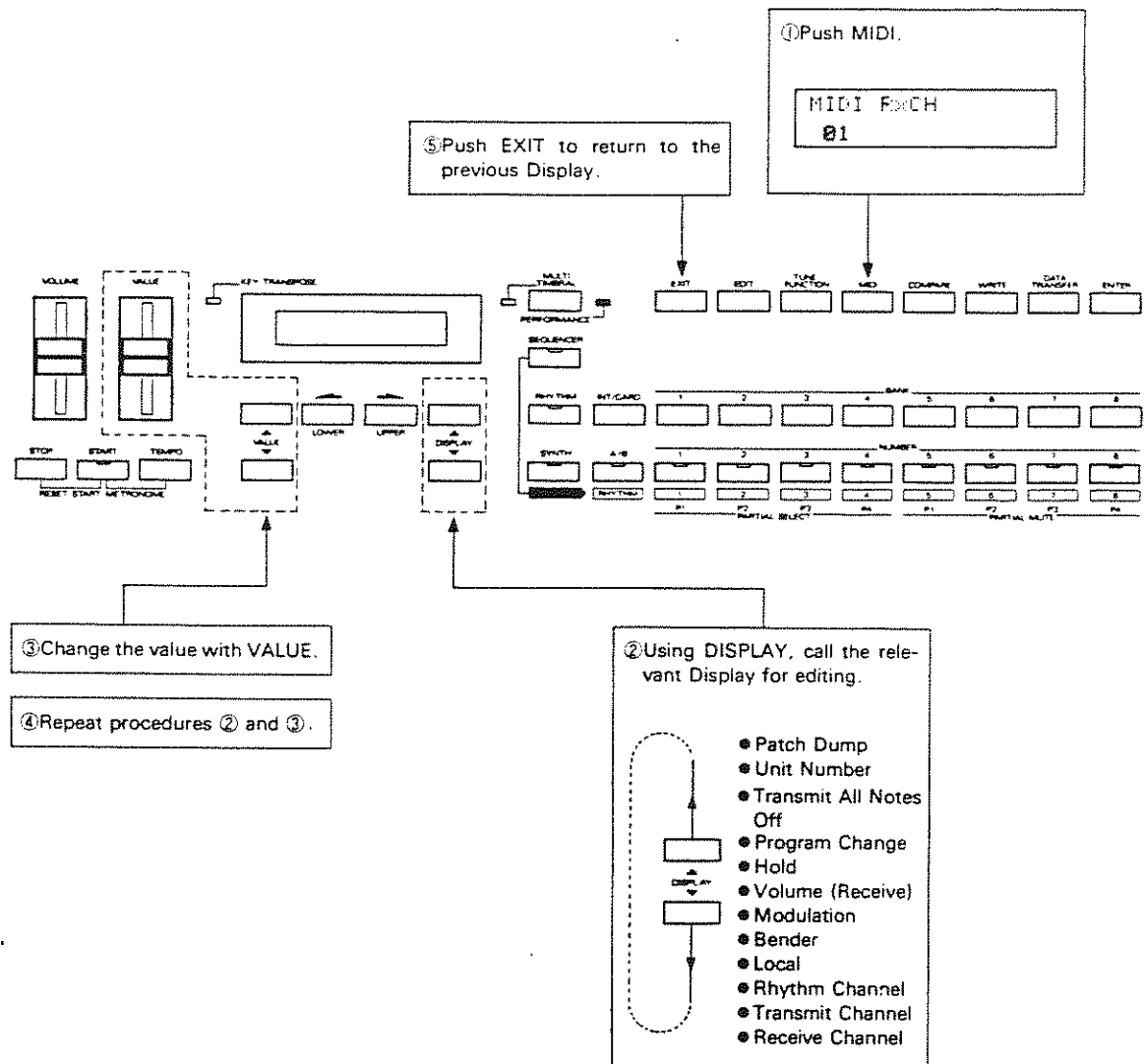

*When the performance data in the Sequencer is transmitted with the Track muted, recorded Bender, Module, Volume, Hold and Program Change messages is transmitted in every MIDI function.

[MIDI Functions]

● MIDI Receive Channel

```
MIDI R×CH
  01
```

This is the MIDI channel on which the performance messages for the synthesizer sound source are received. 1 to 16 are valid.

● MIDI Transmit Channel

```
MIDI T×CH
  01
```

This sets the MIDI channel on which the keyboard performance messages are sent. 1 to 16 are valid.

● MIDI Rhythm Channel

```
MIDI Rhythm CH
  10
```

This sets the MIDI channel on which the rhythm performance messages are transmitted or received. 1 to 16 are valid.

*Changing Rhythm channels here will automatically change the Rhythm Part channel in the Multi Timbral mode.

*In the Play or Sequencer mode, performance messages are transmitted when the Track Mute is turned on.

In the Rhythm mode, performance messages are not transmitted unless the Clock mode is set to "INTERNAL".

● Local

```
MIDI Local
  ON
```

This selects whether to divide the keyboard (or panel controls) and sound module sections or not. When OFF, the keyboard performance messages are sent through MIDI OUT, muting the synthesizer sound source in the D-20 completely. However, this does not prevent the performance messages received through MIDI IN from controlling the D-20's synthesizer section.

*The Local will be automatically set to ON when the unit is turned off.

● Bender

MIDI Bender ON

Set this to ON to receive or transmit Bender messages.

● Modulation

MIDI Modulation ON

To receive or transmit Modulation messages, set this to ON.

● Volume (Receive)

MIDI Rx Volume ON

Set this to ON to receive Volume messages.

● Hold

MIDI Hold ON

Set this to ON to receive or transmit Hold messages.

● Program Change

MIDI Prog. Change
ON

Set this to ON to receive or transmit Program Change messages.

Program Change numbers correspond to the D-20's Patches as shown below.

(The Internal and Memory Card memories have the same Patch numbers in common.)

Group	Number								
	Bank	1	2	3	4	5	6	7	8
A	1	1	2	3	4	5	6	7	8
	2	9	10	11	12	13	14	15	16
	3	17	18	19	20	21	22	23	24
	4	25	26	27	28	29	30	31	32
	5	33	34	35	36	37	38	39	40
	6	41	42	43	44	45	46	47	48
	7	49	50	51	52	53	54	55	56
	8	57	58	59	60	61	62	63	64
B	1	65	66	67	68	69	70	71	72
	2	73	74	75	76	77	78	79	80
	3	81	82	83	84	85	86	87	88
	4	89	90	91	92	93	94	95	96
	5	97	98	99	100	101	102	103	104
	6	105	106	107	108	109	110	111	112
	7	113	114	115	116	117	118	119	120
	8	121	122	123	124	125	126	127	128

*Number 0 to 127 are used as Program Change Messages in the actual MIDI Format.

*The Program Change messages cannot switch the Internal and Memory Card modes.

● Transmit All Notes Off

MIDI T:All N-Off
ON

Set this to OFF if you do not wish to transmit All Notes Off messages.

*The Transmit All Notes Off setting is available for the muted performance data for the Sequencer and is also available in the Multi Timbral Mode.

*The Transmit All Notes Off setting will be automatically set to ON when the unit is turned off.

● Unit Number

MIDI Exclu Unit# 17

A Unit Number is a number used to identify an external device instead of the MIDI channel number, when data is received or transmitted using Exclusive messages (only for Roland ID number). So, it is possible to send or receive Exclusive messages by matching the Unit numbers of two devices. OFF and 17 to 32 are valid, and at OFF, the Exclusive messages cannot be communicated. When using a programmer, be sure not to select OFF.

*Even when sending or receiving Exclusive messages on a MIDI channel, do not set this to OFF but any number from 17 to 32.

*The Unit Number you have set is retained even in the the Multi Timbral mode.

*The Unit Number you have set will be automatically returned to 17 when the unit is turned off.

● Patch Dump

MIDI Patch DUMP OFF

The Patch Dump function transmits the sound data of a certain Patch using Exclusive messages. Using this function, sound data can be recorded in an external sequencer together with performance data. In this way, the original Patch will always be retrieved even after it is edited on the D-20. The Patch Dump function transmit the Exclusive messages with Unit Number.

*The Patch Dump function transmits the data only when changing the Patch with panel operation.

*If you change the value of the Patch Dump, the Timbre Dump setting (see page 11) in the Multi Timbral mode will also be changed automatically.

*The Patch Dump you have set will be automatically returned to OFF when the unit is turned off.

4) MIDI Channel Setting for each Part

When playing an external MIDI sound module using the Track Mute function, it is required to set the MIDI channel of the Part assigned to the relevant Track and the MIDI channel of each external sound module to the same number.

*The MIDI channel setting in each Part is retained even after the unit is turned off.

MIDI channel of each Part is preprogrammed by the manufacturer as shown below.

Part 1	— ch 1
Part 2	— ch 2
Part 3	— ch 3
Part 4	— ch 4
Part 5	— ch 5
Part 6	— ch 6
Part 7	— ch 7
Part 8	— ch 8
Rhythm Part	— ch 10

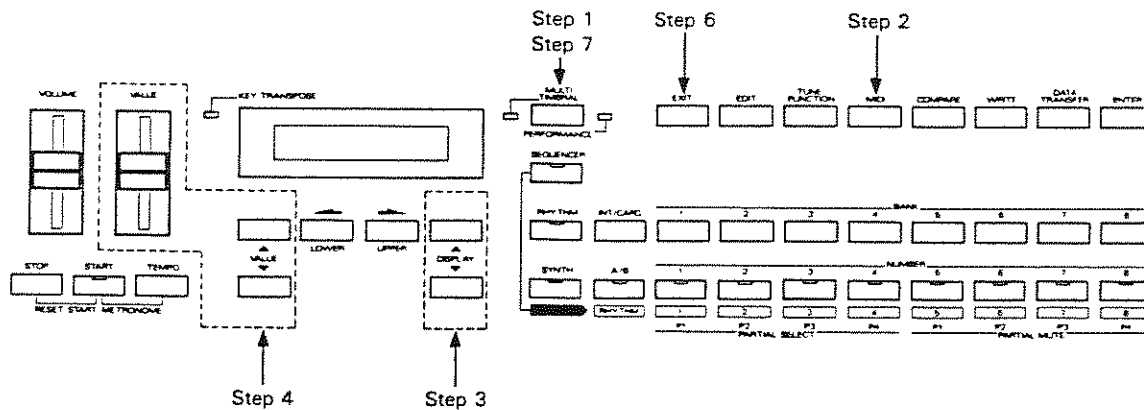

Step 1 Push the Mode Button to select the Multi Timbral mode.

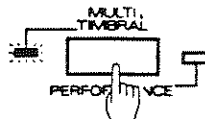

Step 2 Push the MIDI button.

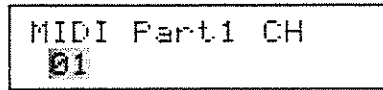

Step 3 Call the MIDI Channel Display of the relevant Part using the DISPLAY button.

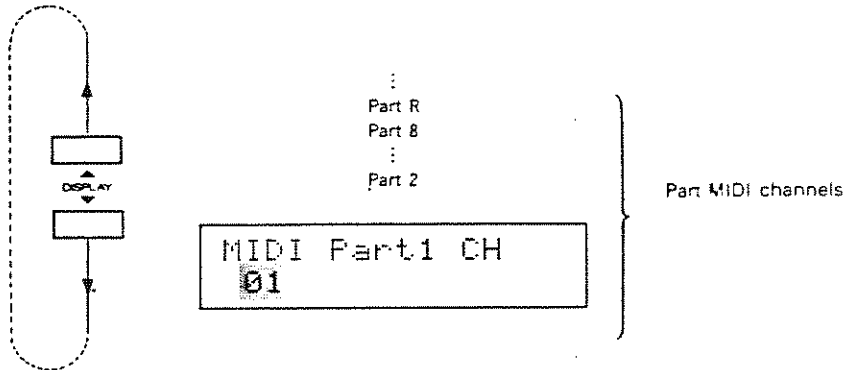

*The MIDI channel of the Rhythm Part is the same number as that in the Performance mode.

Step 4 Change the MIDI channel with the Value Control Knob.

Step 5 To continue to change MIDI channels of other Parts, repeat Steps 3 and 4.

Step 6 Push the EXIT button.

Step 7 Push the Mode Button to return to the Performance mode.

5) Sync

When performing ensemble pieces using a MIDI sequencer's data and the D-20's sequencer data, the tempo of the two devices should be the same speed. That is, one of the two devices should become a slave device to synchronize to the other (=master device).

*Sync signals can be received or transmitted regardless of the MIDI channel setting.

[Using the D-20 as a Master]

Set the external device (=slave) so that it can receive the sync signals sent from the D-20 (=master).

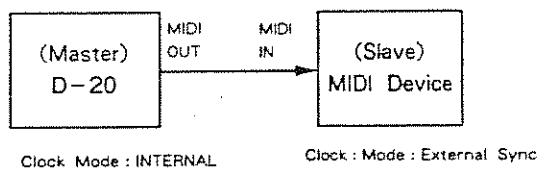

*The D-20 is normally set to the Internal mode.

[Using the D-20 as a Slave]

Set the D-20 (=slave) so that it can receive the sync signal sent from the external device (=master).

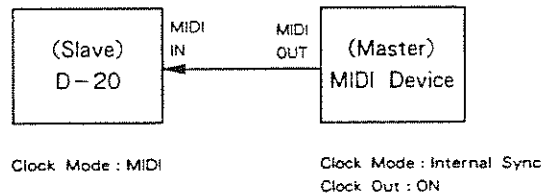

When the D-20 is set to the MIDI mode, [tempo] will be shown as below, and the D-20 can no longer control the tempo.

```

┌ =MIDI
│ Rthm 50 M.M. 50
└
  
```

[Clock Mode Setting]

To enter the Clock mode, do as follows.

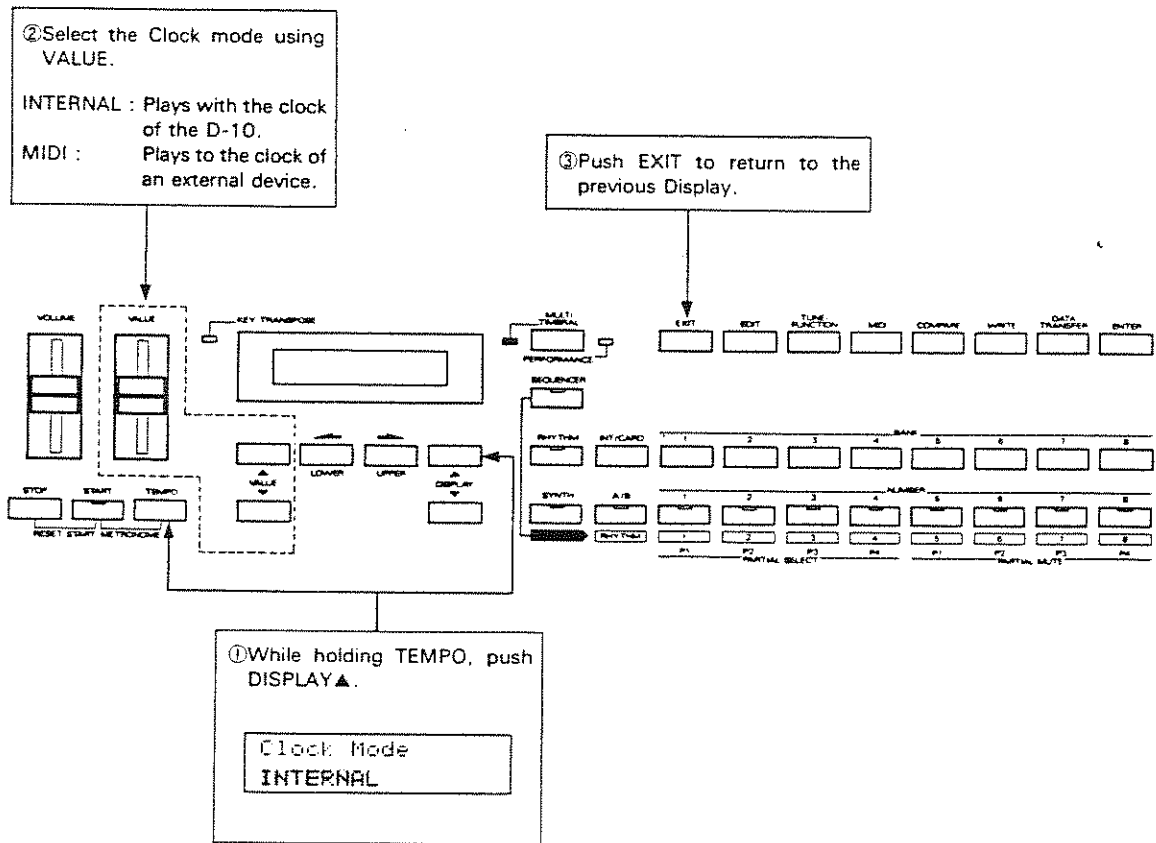

*The Clock mode you have set will be retained even after the unit is turned off.

*If you do not wish to use the D-20 but use it as a MIDI sound module, be sure to set the D-20 to the Internal mode. This is to prevent the built-in sequencer from playing in sync with the signal from the external device.

2. Multi Timbral Mode

a. Using MIDI Devices

The following are examples for using the Multi Timbral mode effectively.

1) How MIDI Messages run

The following shows how MIDI messages run in the Multi Timbral mode.

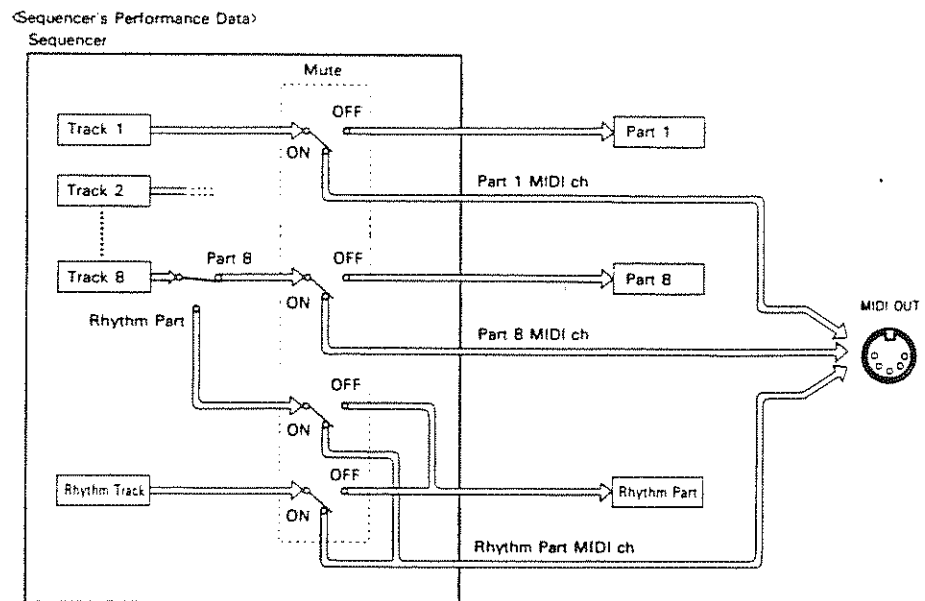
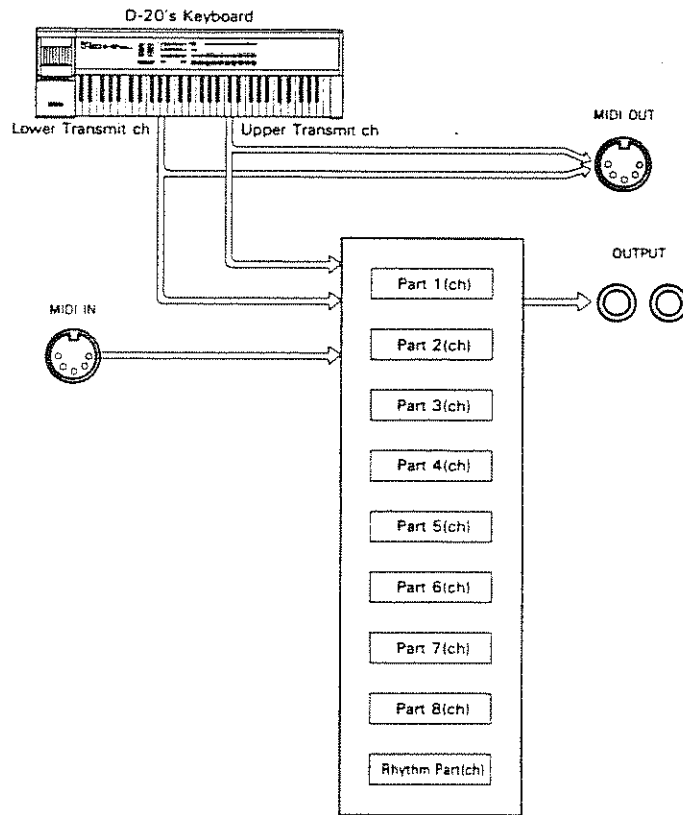

- Keyboard performance messages are transmitted on each MIDI transmit channels, the Upper and Lower.
- Performance messages fed into MIDI IN play the relevant Part which the same MIDI channel is assigned to.
- Regarding the Sequencer data, only the performance data of the muted Tracks are transmitted through MIDI OUT (on the MIDI channel of the corresponding Part).
- Timbre selection messages on the D-20 (=Program Change) messages are transmitted from the MIDI OUT using the MIDI transmit channel of keyboard.

[Program Change]

Program Change numbers correspond to the Timbres of the D-20 as shown below. (Timbres in the Internal memory share the same numbers with the Timbres on a memory card.)

Group	Number								
	Bank	1	2	3	4	5	6	7	8
A	1	1	2	3	4	5	6	7	8
	2	9	10	11	12	13	14	15	16
	3	17	18	19	20	21	22	23	24
	4	25	26	27	28	29	30	31	32
	5	33	34	35	36	37	38	39	40
	6	41	42	43	44	45	46	47	48
	7	49	50	51	52	53	54	55	56
	8	57	58	59	60	61	62	63	64
B	1	65	66	67	68	69	70	71	72
	2	73	74	75	76	77	78	79	80
	3	81	82	83	84	85	86	87	88
	4	89	90	91	92	93	94	95	96
	5	97	98	99	100	101	102	103	104
	6	105	106	107	108	109	110	111	112
	7	113	114	115	116	117	118	119	120
	8	121	122	123	124	125	126	127	128

*Number 0 to 127 are used as Program Change Messages in the actual MIDI Format.

*Program Change messages are transmitted only when a Timbre is selected in the Keyboard Display using the MIDI transmit channel of the keyboard in the Display.

*Program Change messages cannot switch the Internal and Memory Card Modes.

2) Examples

The following are examples for using the Multi Timbral mode effectively.

[Using an external MIDI sound module]

○Playing the D-20 and the MIDI sound module from the keyboard and playing other parts with the built-in sequencer.

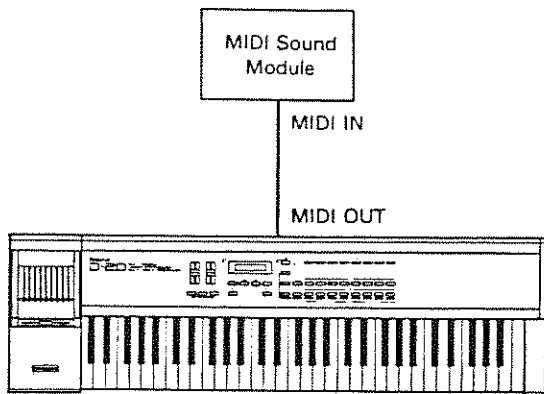

Channel Setting Example:

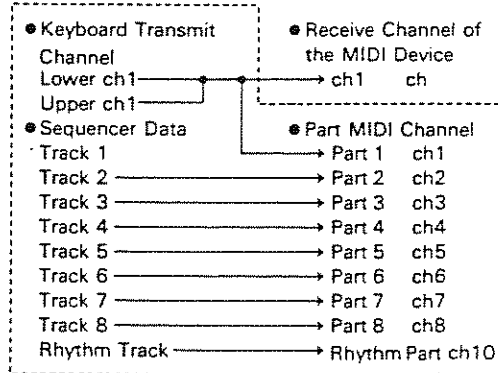

○Playing the MIDI sound module from the keyboard and each part with the built-in sequencer.

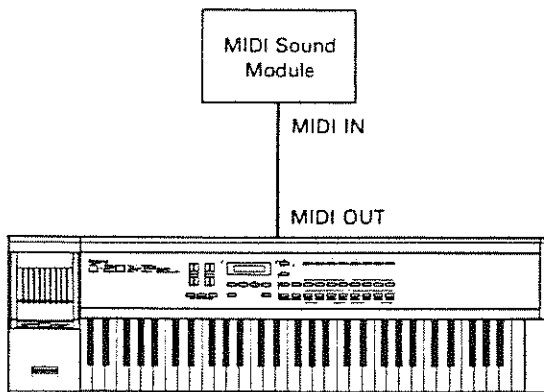

Channel Setting Example:

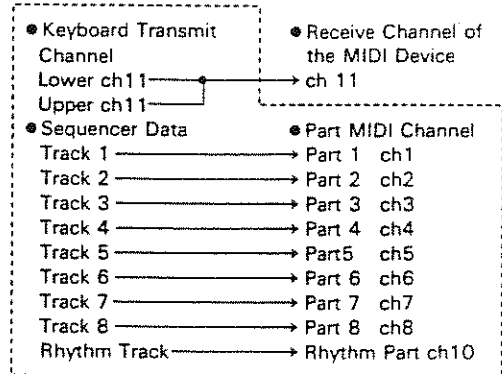

○Playing more than several MIDI sound modules with the built-in sequencer.

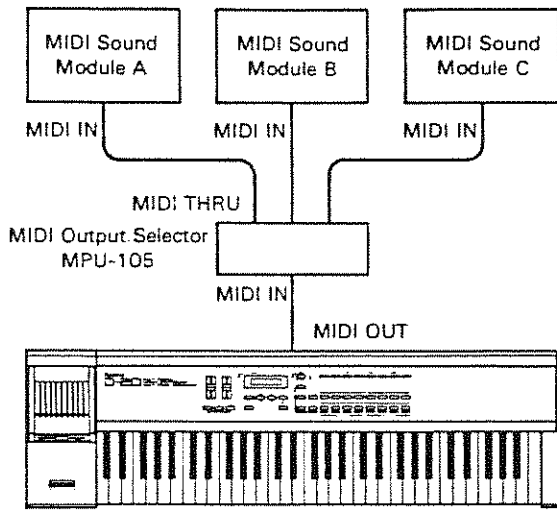

Channel Setting Example:

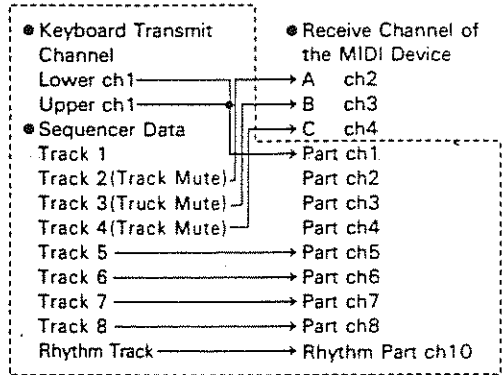

[Using the D-20 as a MIDI sound module]

○Playing the D-20's sound module with an external MIDI sequencer.

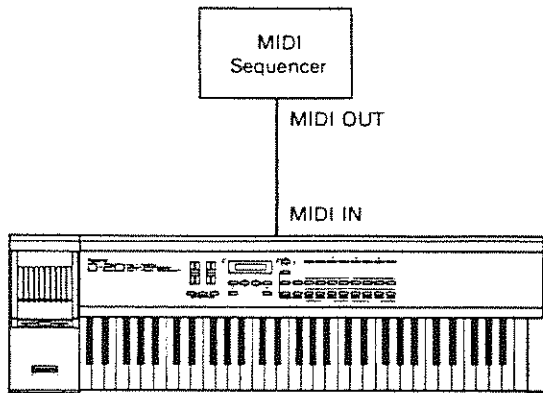

Channel Setting Example:

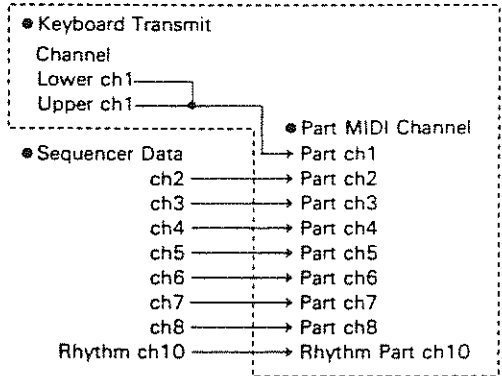

3) Sync

When performing ensemble pieces using a MIDI sequencer's data and the D-20's sequencer data, the tempo of the two devices should be the same speed. That is, one of the two devices should become a slave device to synchronize to the other (=master device).

*Sync signals can be received or transmitted regardless of the MIDI channel setting.

[Using the D-20 as a Master]

Set the external device (=slave) so that it can receive the sync signals sent from the D-20 (=master).

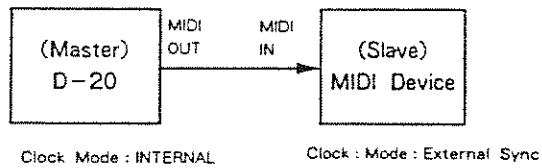

*The D-20 is normally set to the internal mode.

[Using the D-20 as a Slave]

Set the D-20 (=slave) so that it can receive the sync signal sent from the external device (=master).

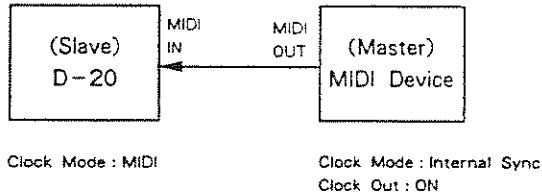

When the D-20 is set to the MIDI mode, [tempo] will be shown as below, and the D-20 can no longer control the tempo.

```

┌=MIDI
Rthm 50 M.M. 50
  
```

[Clock Mode Setting]

To enter the Clock mode, do as follows.

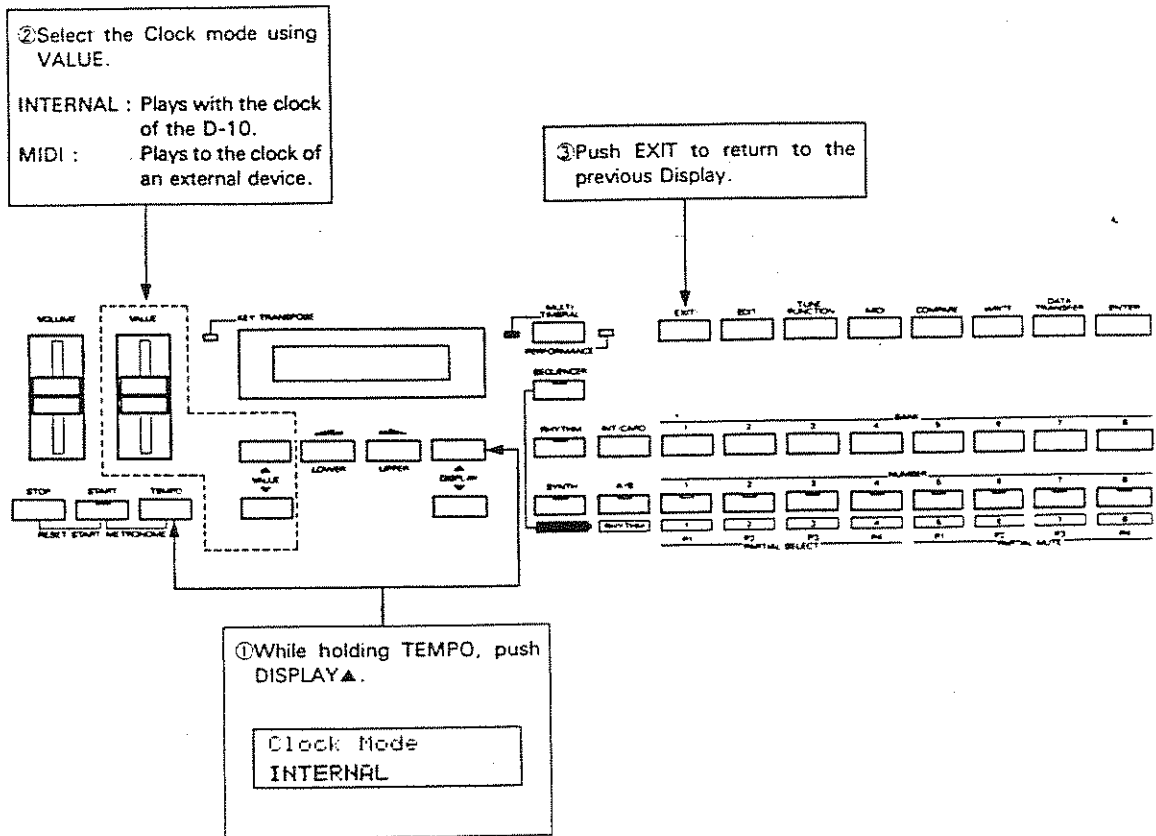

*The Clock mode you have set will be retained even after the unit is turned off.

*If you do not wish to use the D-20 but use it as a MIDI sound module, be sure to set the D-20 to the Internal mode. This is to prevent the built-in sequencer from playing in sync with the signal from the external device.

b. Recording from an external sequencer

When the D-20 is set to the Multi Timbral mode, you can record the entire performance data programmed with an external sequencer into the built-in sequencer.

[Notes]

- When the D-20 is set to the Performance mode, the data cannot be recorded from an external sequencer.
- Before recording, set the MIDI channel of each performance data on the external sequencer to the MIDI channel of the Part that corresponds to each Track of the D-20's sequencer unit to the same number. (If the MIDI channel is not properly set, the performance data cannot be recorded.)
- The Rhythm performance data can be recorded in Track 8. When recording rhythm performance data at the same time, set the MIDI channel of the rhythm performance data, and the MIDI channel of the Rhythm Part to the same number.
- Selecting this "external sequencer's recording mode" will erase the entire performance data recorded in the D-20.

[Connection]

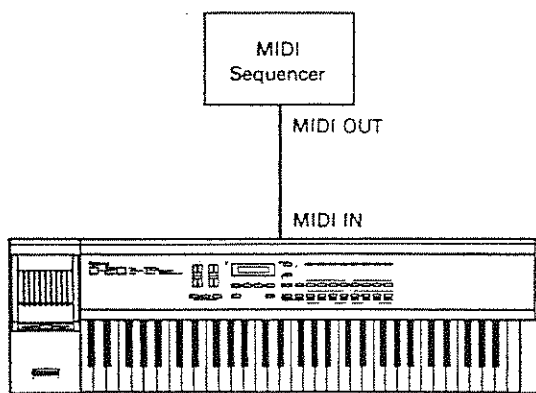

[Operation]

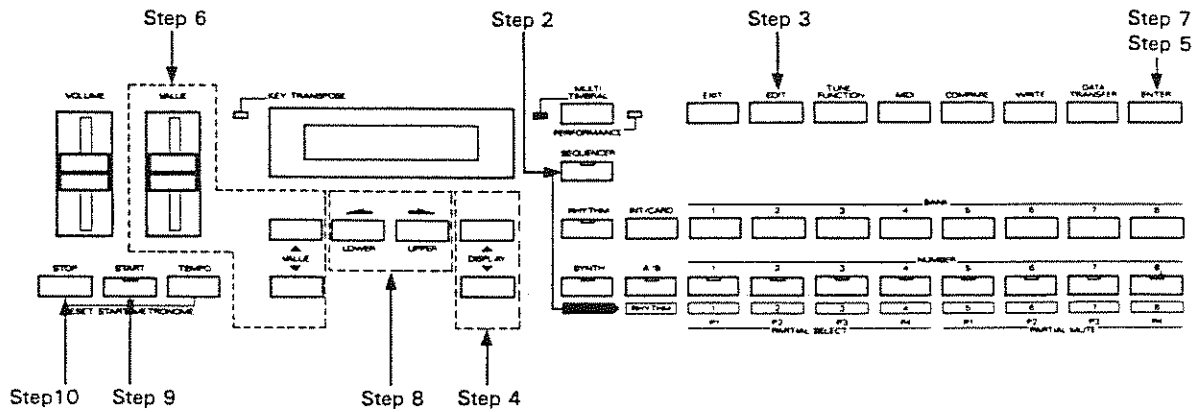

- Step 1 Set the external sequencer ready for playing.
- Step 2 Push the SEQUENCER button. (The indicator lights up.)
- Step 3 Push the EDIT button.
- Step 4 Call the following Display using the DISPLAY buttons.

```

External REC
Sure?      Enter
    
```

- Step 5 Push the ENTER button.

```

REC
Time 4/4  Enter
    
```

- Step 6 Set the beat (1/4 to 8/4) using the Value Control Knob.

Step 7 Push the ENTER button.

```
Track 8 Select  
Part8 Rhythm
```

Step 8 To record rhythm data in Track 8, push the right Cursor Button. If not, push the left Cursor Button.

The Display responds as below, and meanwhile, all the Track (NUMBER) Indicators flash (red).

```
REC  
Mess001 External
```

Step 9 Start recording.

When using the D-20 as a master device, push the START button on the D-20. When using the external sequencer as a master, start the external sequencer.

The indicator of the Track where performance data has been recorded stops flashing and remains alight.

Step 10 When finished recording, push the STOP button on the master device.

When using the D-20 as a master device, push the STOP button on the D-20. When using the external sequencer as a master, stop the external sequencer.

The indicator of the recorded Track flashes (green), and the unit is returned to the Sequencer mode.

5 DATA TRANSFER

The entire data in the internal memory can be copied onto a memory card or disk, or the entire data on a memory card or disk into the internal memory.

Also, using Roland MIDI Exclusive messages, the data can be transferred from one D-20 to another D-20.

*If an Error Message is shown in the Display, resolve it by following the "Error Messages" on page 212.

1. Copying with a Floppy disk

The entire data in the internal memory of the D-20 can be copied on a disk. This is called saving. Copying data on a disk into the internal memory is called loading.

Initializing the entire data on a disk is called formatting. Erasing a File of data on a disk is called deleting.

[NOTES]

- Use a 3.5", double density floppy disk, such as the Roland MF2-DD.
- Disks and disk drives are delicate, and can be easily damaged if not treated properly. Read "Important Notes" on page 2 in Volume 1.
- A brand new floppy disk cannot be used unless formatted as explained on page 177. This applies to a floppy disk that contains data for other than the D-20.

[File]

Data is stored on a disk with a file name. There are four types of files which are optional depending on the situation, but usually use "All".

Data \ File Type (Signature)	All (↓ 'l, ♣)	Song (↓)	Sound ('l)	Rhythm (♣)
128 Patches (A11-88, B11-88)	○		○	
128 Timbres (A11-88, B11-88)	○		○	
64 Tones (i1-64)	○		○	
Sequencer Tracks (1-8)	○	○		
Sequencer Rhythm Track (1)	○	○		○
32 Rhythm Patterns (P-51-88)	○	○		○
Rhythm Setup (1 Set)	○	○		○

*The Display shows the file type with symbol.

a. Formatting

Formatting a disk is necessary to make it capable of saving data.

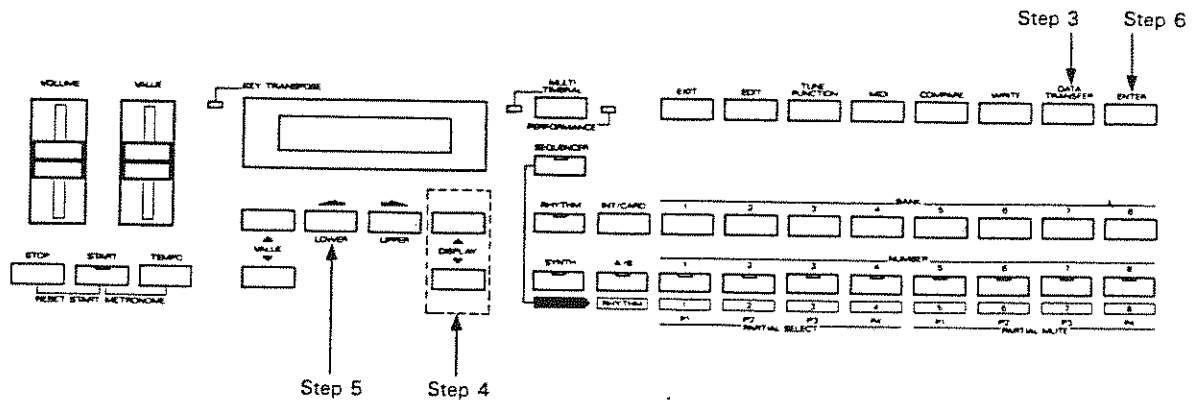

Step 1 Set the Protect Tab on the disk to "WRITE".

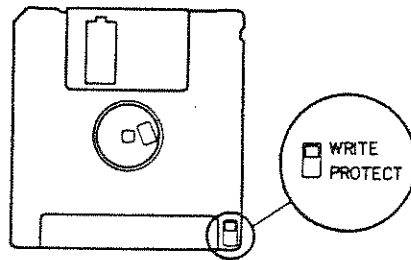

Step 2 Insert the disk into the Disk Drive.

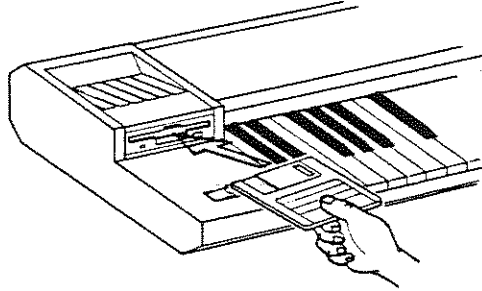

Step 3 Push the DATA TRANSFER button.

```
Disk Select
Save      Load
```

Step 4 Call the following Display using the DISPLAY buttons.

```
Disk Select
Format Delete
```

Step 5 Push the left Cursor Button.

```
DiskFormat Sure?
Enter
```

Step 6 Push the ENTER button.

```
Disk Formatting*  
 . . .
```

The number of dots increases. →



When the disk is properly formatted, the following Display is shown for a while, then returns to the previous Display before Data Transfer was performed.

```
Complete
```

*The Disk Drive clicks when it starts, but this is nothing to worry about.

*Disk Formatting takes about 150 seconds.

*If the disk is not formatted properly, an Error Message will be shown in the Display. Resolve it by following "Error Messages" on page 212.

b. Saving

Data in the internal memory can be saved onto a disk for future use.

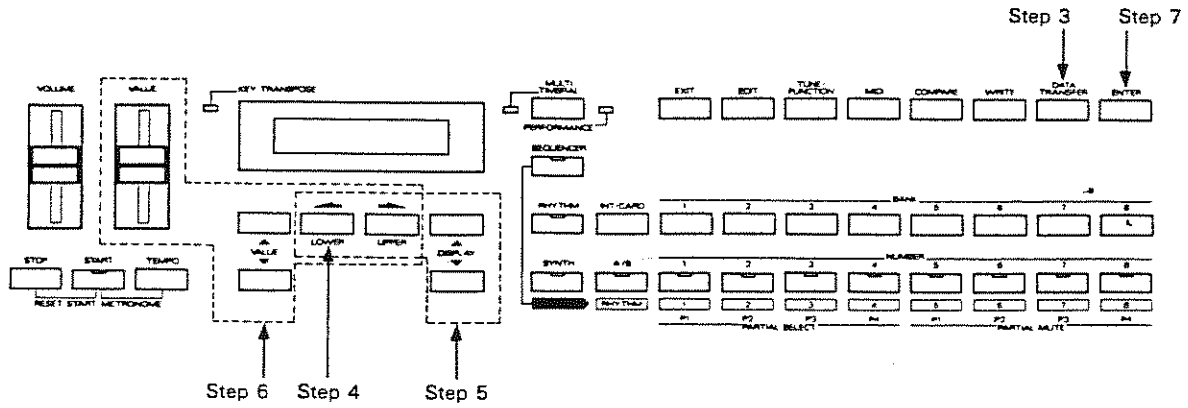

- Step 1 Set the Protect Tab on the disk to "WRITE".
- Step 2 Insert the disk into the Disk Drive.
- Step 3 Push the DATA TRANSFER button.

```

Disk Select
Save      Load
    
```

- Step 4 Push the left Cursor Button.

```

Disk Save Select
All          Song
    
```

Step 5 Select the type of data to be transferred.

○Select "All" or "Song" while the following Display is being shown.

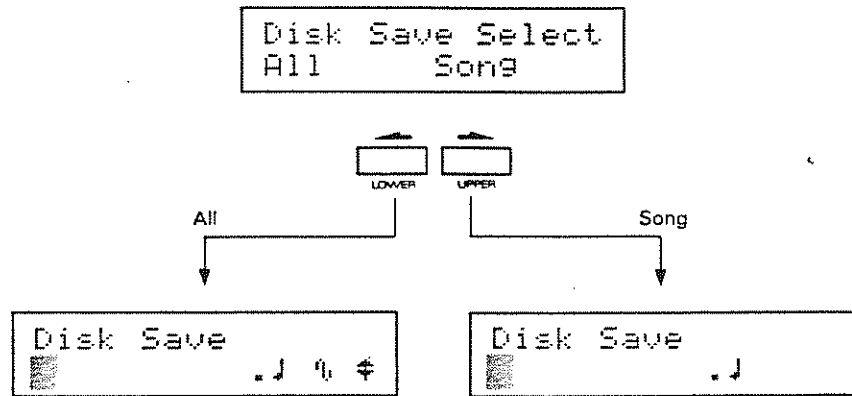

*When the data already has a Song Name, it is shown in the Display. If you wish to use the Song Name as a File name, go to Step 7.

○"Sound" or "Rhythm" can be selected with the Cursor Buttons in the next Display.

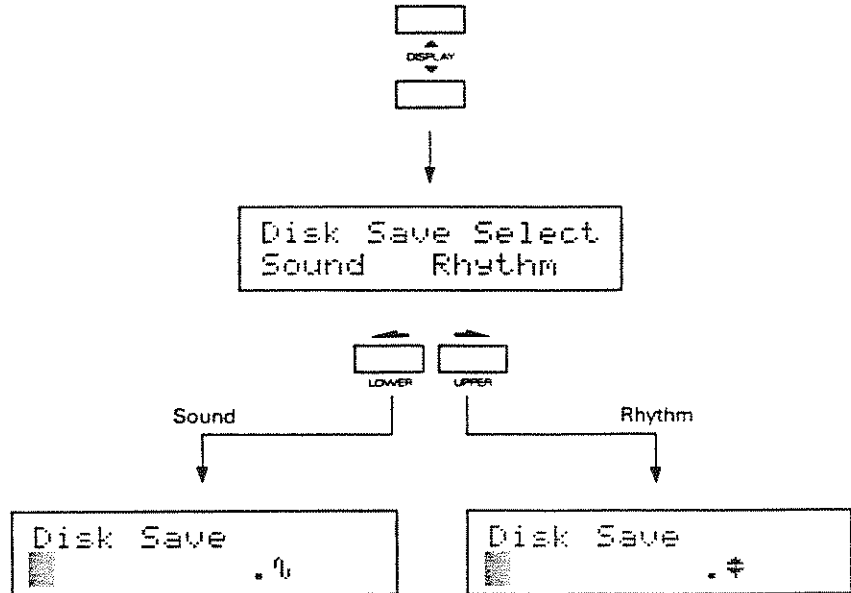

*If "All" or "Song" is selected, the rhythm level and reverb parameters (only in the Multi mode) are simultaneously written.

☆If similar kind of the data using the same File name and File type is already saved on the disk, the following Display appears.

If you wish to save it again on the same file, push the ENTER button, and the previous data will be replaced with the new data. If you wish to retain the current data as well as the new data, push the EXIT button. Step 6's Display will be called, for you to change the File name and save it.

```
Disk Save Renew?  
▲▲▲▲▲▲▲▲▲▲▲.J % #
```

☆If the remaining capacity of a disk is too small for the data to be saved, the following Display is shown for a while then returned to the Saving/Loading Display. Delete any un-needed File (see page 186) or use a new disk.

```
Disk Full
```

c. Loading

Data saved on a disk can be copied into the internal memory.

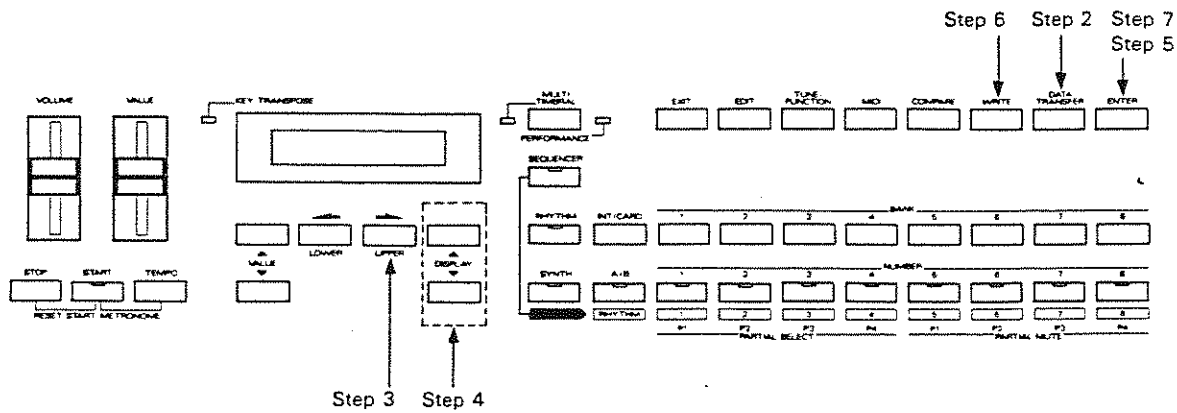

Step 1 Insert a disk into the Disk Drive.

Step 2 Push the DATA TRANSFER button.

```

Disk Select
Save Load
    
```

Step 3 Push the right Cursor Button.

```

Disk Load Sure?
-----
    
```

After a few seconds, the file name and the type of data are displayed.

Step 4 Select the File to be loaded with the DISPLAY buttons.

Step 5 Push the ENTER button.

```

Turn Protect off
once? Write/Exit
    
```

d. Deleting

A File of data saved on a disk can be deleted.

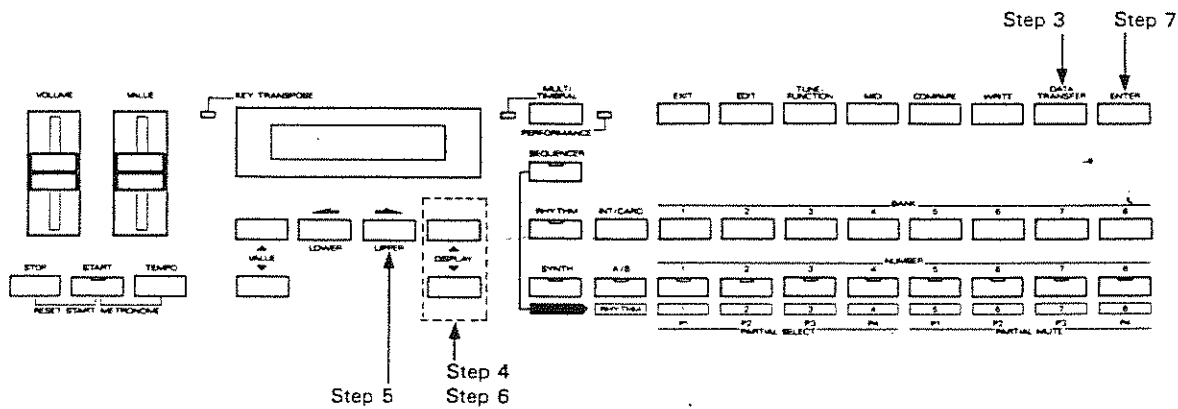

- Step 1 Set the Protect Tab on the disk to "WRITE".
- Step 2 Insert the disk into the Disk Drive.
- Step 3 Push the DATA TRANSFER button.

```

Disk Select
Save      Load
    
```

- Step 4 Call the following Display with the DISPLAY buttons.

```

Disk Select
Format    Delete
    
```

- Step 5 Push the right Cursor Button.

```

DiskDelete Sure?
-----
    
```

After a few seconds, the file name and the type of data are displayed.

- Step 6 Select the File to be deleted, with the DISPLAY buttons.

Step 7

Push the ENTER button.

```
Disk Deleting  [Progress Bar]
#####.J 0  #
```



When the data is properly deleted, the following Display is shown for a while, then returns to the previous Display before Data Transfer was performed.

```
Complete
```

*If the data is not properly deleted, an Error Message is shown in the Display. Resolve this by following "Error Messages" on page 212.

2. Copying with a Memory Card

The entire data in the internal memory of the D-20 can be copied on a memory card. This is called saving. Copying data on a memory card into the internal memory is called loading.

[Data which can be saved]

The optional memory card (M-256D, M-256E) can store the following data.

All	Sound	Patches : 128 (A11-88, B11-88) Timbres : 128 (A11-88, B11-88) Tones : 64 (c1-64)
	Rhythm	Rhythm Patterns : 32 (P-51-88) Rhythm Track : 1 Rhythm Setup

a. Saving

Data in the internal memory can be saved onto a memory card for future use.

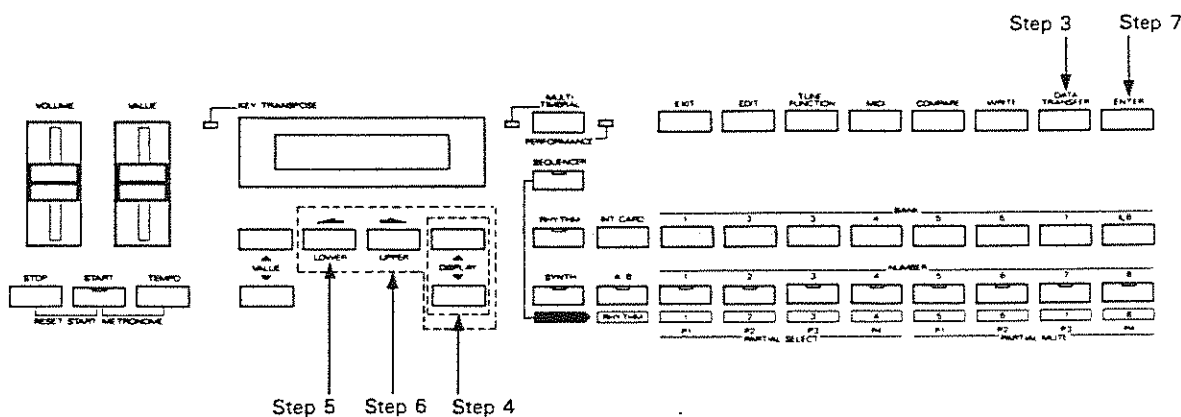

- Step 1 Insert a memory card into the Card Slot.
- Step 2 Set the Protect Switch on the memory card to OFF.

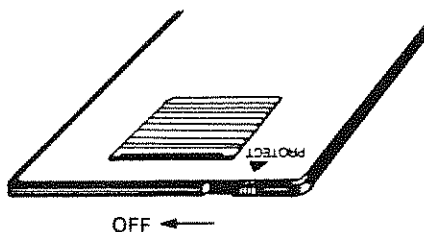

- Step 3 Push the DATA TRANSFER button.

```

Disk Select
Save      Load
    
```

- Step 4 Call the following Display with the DISPLAY buttons.

```

Card Select
Save      Load
    
```

- Step 5 Push the left Cursor Button.

```

Card Save Select
All
    
```

Step 6 Select the data to be saved.

○To save the entire data in memory, push either of the Cursor Buttons.

```

    Card Save Select
    All
    
```

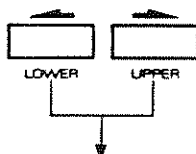

```

    Card Save      All
    Sure?         Enter
    
```

○To save either of the data blocks, push either of the DISPLAY buttons, and assign the data block using the Cursor Buttons.



```

    Card Save Select
    Sound  Rhythm
    
```

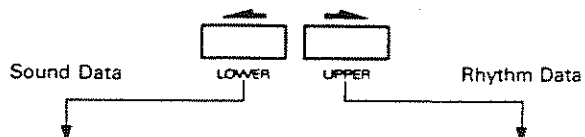

```

    Card Save  Sound
    Sure?     Enter
    
```

```

    Card Save Rhythm
    Sure?     Enter
    
```

*If you are using a memory card which has never been used for writing data, "All" is the only alternative.

Step 7 Push the ENTER Button.

When data is properly saved, the Display responds as below for a while and returns to the previous Display (before the data transfer procedure was used).

Complete

If you are using a memory card which has never been used for writing data, the following is shown in the Display. If so, push the ENTER button again.

Illegal Card
Enter

*If an Error Message is shown in the Display, resolve it by following the "Error Messages" on page 212.

Step 8 Return the Protect Switch on the memory card to ON.

b. Loading

Data on a memory card can be copied back to the internal memory.

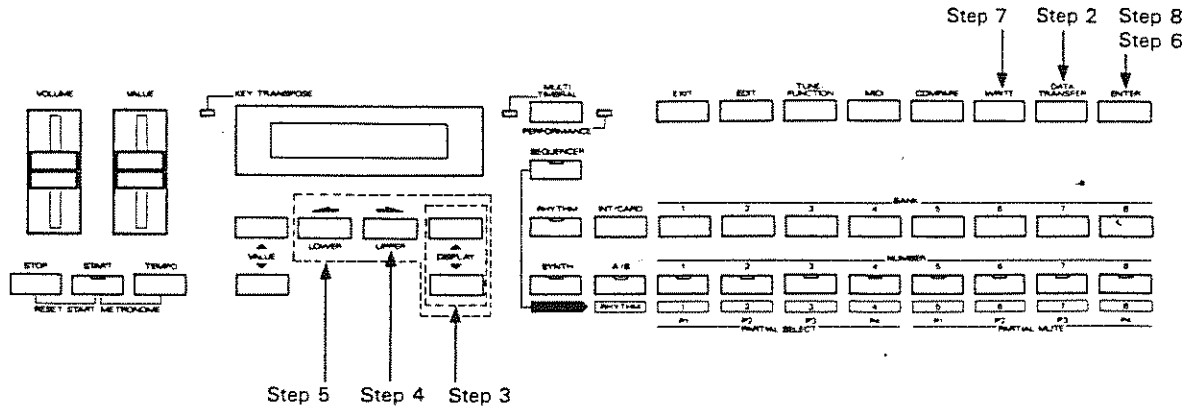

Step 1 Insert a memory card into the Card Slot.

Step 2 Push the DATA TRANSFER button.

```

Disk Select
Save      Load
    
```

Step 3 Call the following Display with the DISPLAY buttons.

```

Card Select
Save      Load
    
```

Step 4 Push the right Cursor Button.

```

Card Load Select
All
    
```

Step 5 Select the data to be loaded.

○ To copy the entire data, push either of the Cursor Buttons.

```

Card Load Select
All
    
```

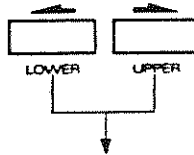

```

Card Load      All
Sure?          Enter
    
```

○ To copy a block of data, push either of the DISPLAY buttons, then assign the block using the Cursor Buttons.

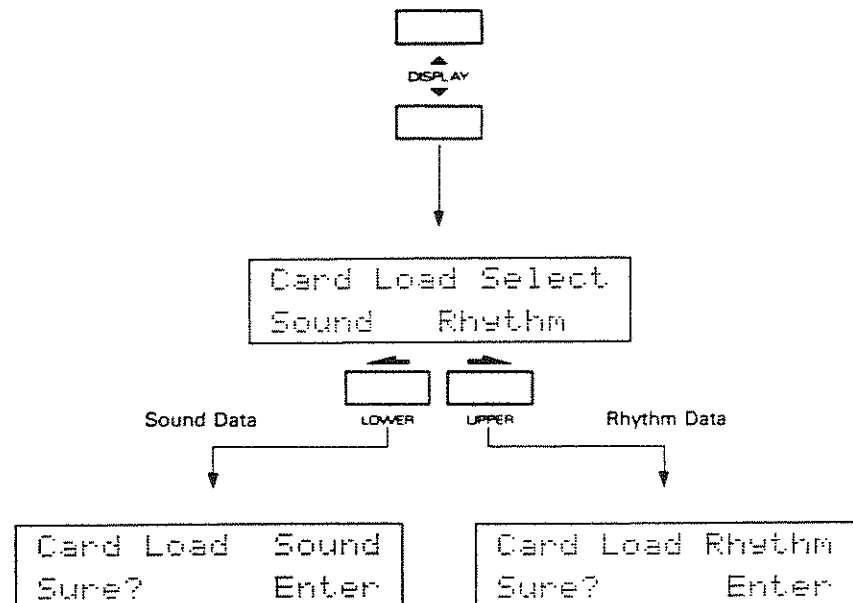

Step 6 Push the ENTER button.

```
Turn Protect off  
once? Write/Exit
```

Step 7 Push the WRITE button.

The Memory Protect is released, and the Display returns to that of Step 5.

Step 8 Push the ENTER button.

When the data is properly loaded, the Display responds as shown below for a while, then returns to the previous Display (before the loading procedure was taken).

```
Complete
```

*If an Error Message is shown in the Display, resolve it by following the "Error Messages" on page 212.

2. Data Transfer with MIDI

Using Roland MIDI Exclusive messages, the data can be transferred from one D-20 to another D-20.

[Data which can be transferred]

The Data Transfer function of the D-20 allows you to divide the entire data into two blocks separately, Sound data and Rhythm data,

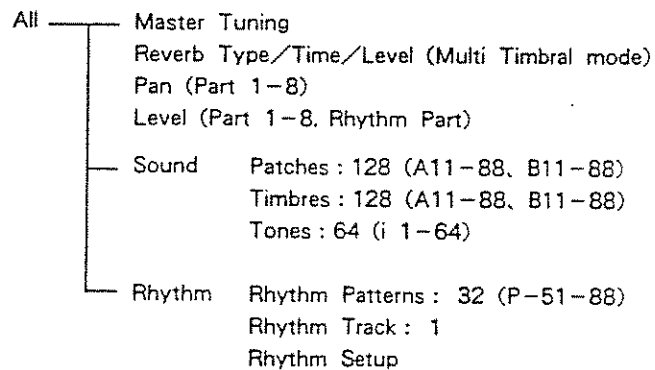

[How to transfer data]

There are two methods of data transfer via MIDI: Handshake and One-way.

○Handshake allows you to verify whether the receiver is ready to receive the data.

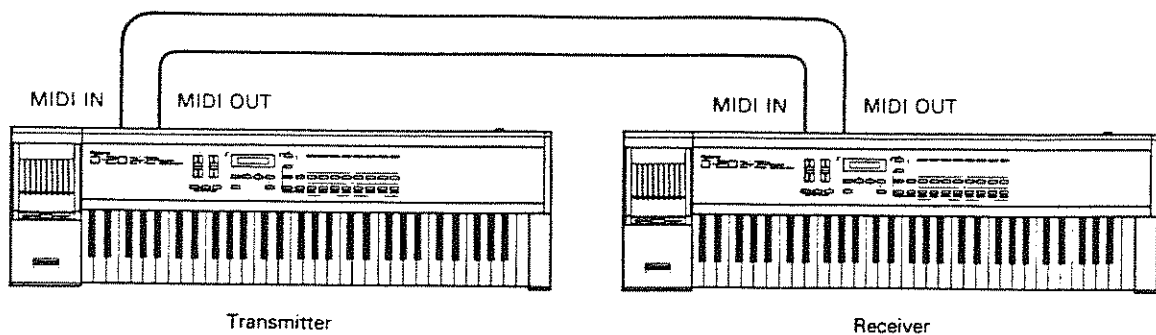

○One-way transfers the data without confirming the condition of the receiver. The D-20 allows you to select either of the two methods.

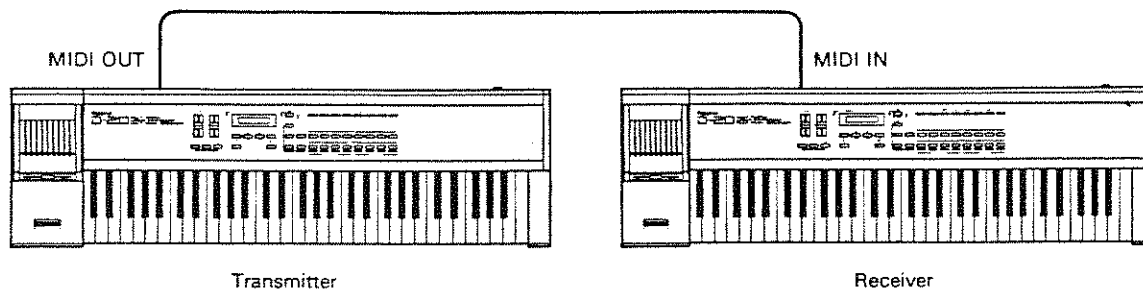

[Procedure]

Step 1 Set the Unit number of the receiver and transmitter to the same number.

① Push the MIDI button.

② Push the DISPLAY button until the Display responds as below.

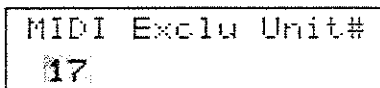

③ Set the Unit number using the Value Control Knob.

Step 2 Push the DATA TRANSFER buttons on both the receiver and transmitter.

Step 3 Push the DISPLAY buttons on both the receiver and transmitter until the Display responds as shown below.

<One-way>

```

One-way Bulk
DUMP      Load
    
```

<Handshake>

```

Handshake Bulk
DUMP      Load
    
```

(The following procedure is common for both One-way and Handshake.)

Step 4 Push the left Cursor Button on the transmitter and the right on the receiver.

<Transmit>

```

H-shake DUMP Sel
All
    
```

<Receive>

```

H-shake Load Sel
All
    
```

Step 5 Match the data group of the receiver and transmitter.

○To transfer the entire data, push either of the Cursor Buttons.

(Transmit, Receive)

```

H-shake ▲▲▲▲ Sel
All
    
```

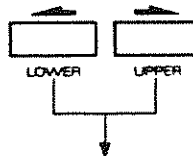

```

H-shake ▲▲▲▲ All
Sure?      Enter
    
```

○To transfer Rhythm or Sound block, push either of the DISPLAY Buttons, then assign the block using the Cursor Buttons.

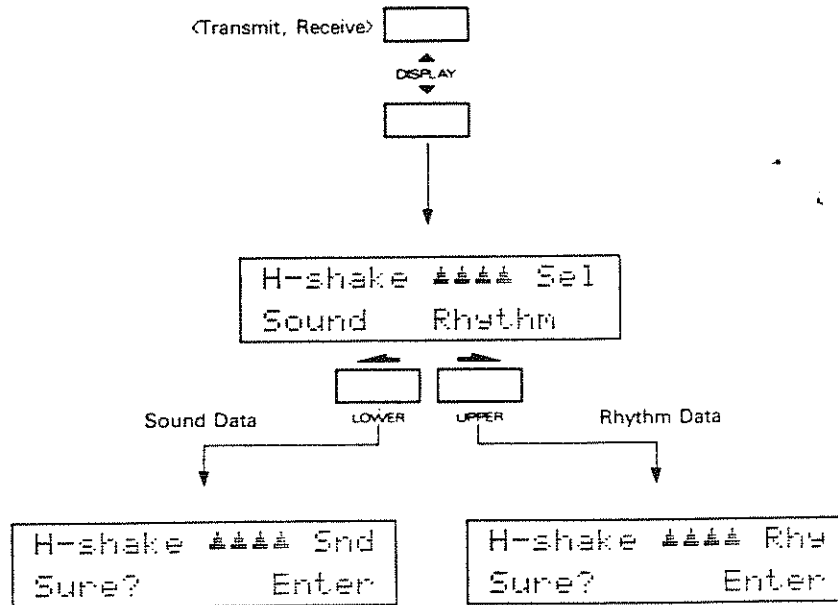

Step 6 Push the ENTER button on the receiver.

```

  Turn Protect off
  once? Write/Exit
  
```

Step 7 Push the WRITE button on the receiver.

The Memory Protect function is cancelled, and the Display returns to that of Step 5.

Step 8 Push the ENTER button on the receiver.

Now, the receiver unit is ready.

```

  H-shake Load ▲▲▲
  Waiting
  
```

Step 9 Push the ENTER button on the transmitter.

When the data is properly copied, the Display responds as shown below for a while, then returns to the previous Display (before the data transfer procedure was taken).

Complete

*If an Error Message is shown in the Display, resolve it by following the "Error Messages" on page 212.

6 LA Synthesis

LA stands for Linear Arithmetic synthesis which is the heart of the new technology. LA synthesis involves a great many technological advances resulting not only in a superior sound quality but also an improved ease of programming. In this way, Roland has succeeded in maintaining a high degree of familiarity to the user despite the technical wizardry involved.

1. What is sound made of ?

[Three elements of a sound]

Sounds are air vibrations reaching our ears. By transforming the vibration into digital signals, it would become visible as a "wave".

Air Vibration

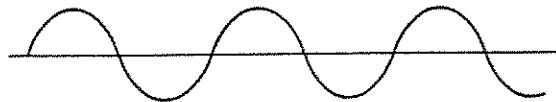
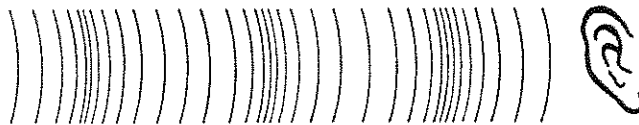

Waveform

Basically, all sorts of sounds can be considered to consist of "pitch", "timbre" and "volume".

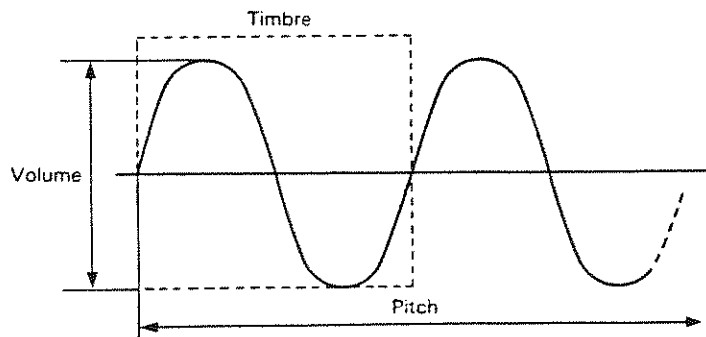

- (1) Pitch is determined by the number of waves (=frequencies). Higher frequencies raise the pitch. Usually, pitch (frequency) is represented by Hz.



Low pitch



High pitch

- (2) Timbre is determined by the shape of a wave. Generally speaking, round shaped waves make soft sounds, and sharp shapes make hard sounds.



Soft tone



Hard tone

- (3) Volume is determined by the depth of a wave (=amplitude). Larger waves produce higher volumes.



Low volume

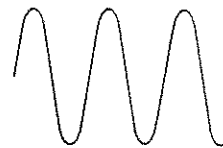

High volume

【Harmonics】

Timbre is determined by the shape of a wave. Then, how is the shape of a wave made? It is believed that a waveform is made by a great many sine waves. For example, a sawtooth is made by adding sine waves of all the possible multiples to the fundamental sine wave. A square wave is made by odd number multiples added to the fundamental.

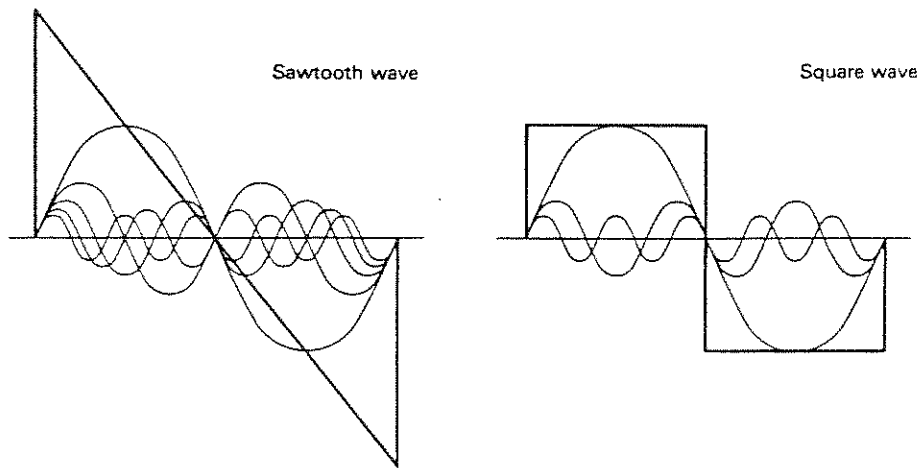

The waves added to the fundamental are called "harmonics": even number multiple harmonics and odd number multiple harmonics. A timbre, in brief, is determined by the harmonic content.

[Envelope]

Each of the three elements, pitch, timbre and volume, has its own envelope curve. Each instrument sound has a different envelope.

Envelope of an instrument volume

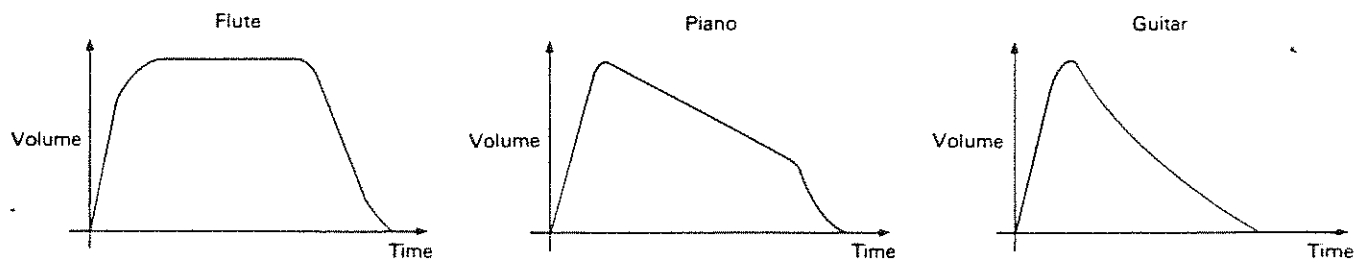
**[Natural Sounds]**

A natural sound consists of various different sounds. For example, a piano consists of a sharp attack sound then a decay sound. These two are completely different sounds. Also, the timbre of a piano sound varies depending on the pitch.

2. Understanding LA Synthesis

The LA system allows you to combine various different sections when making a sound. In other words, each independent Partial makes its own sound, and is then combined (synthesized).

The Structure may be the most important parameter of the D-20, as it decides how to combine the Partials.

a. Structure

Please study the following examples.

13 Structures may be divided into two groups, with the ring modulator, and without.

[Structures that do not use Ring Modulators]

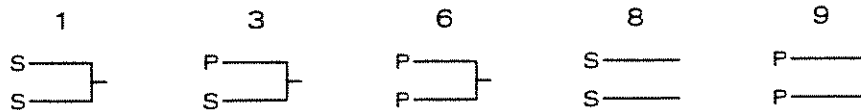

Structure 1/3/6

These can be combined as follows.

(1) By setting each Partial the same, and detuning slightly, a fat sound can be created. Also, shifting the pitch by one octave or a 5th may be effective. This is suitable for strings or organ sounds.

- (2) To make a realistic sound, use the PCM sound generators for attack sounds. For example, to create a wind instrument sound, make a blowing sound with the PCM generator, then the sustained sound with a PCM loop or synthesizer generator.

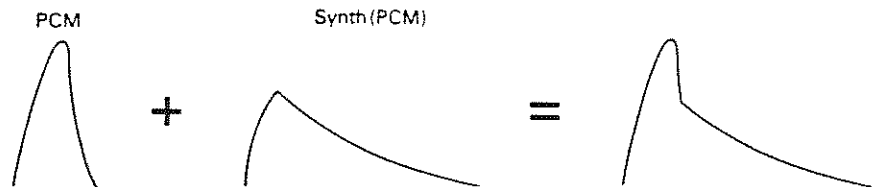
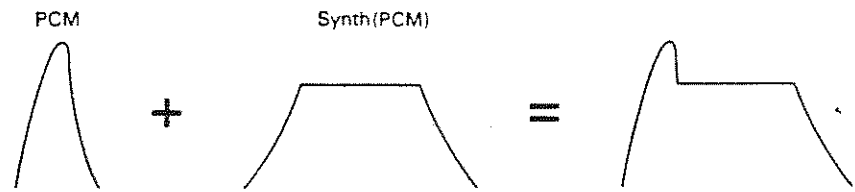

- (3) Make a bright and dark sound in each Partial separately, then reverse the polarity of the TVA Velocity. Then the tone can be altered by changing how you play the keyboard.

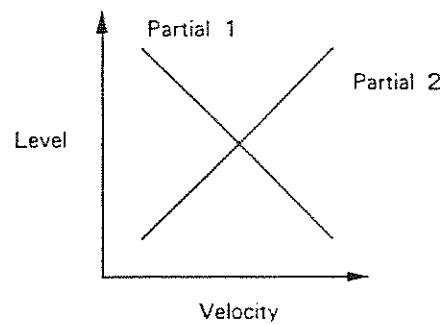

- (4) Make the upper and lower section sounds in each Partial separately, then reverse the bias setting of the TVA. Then different tones can be heard by changing the keyboard range.

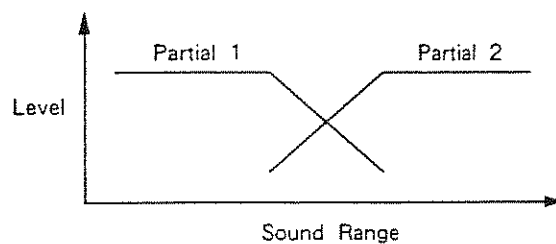

Structure 8/9

These are useful for creating stereo effects. However, the pan setting loses effect in this Structure, so the sound image cannot be changed. (See page 169.)

[Using the Ring Modulator]

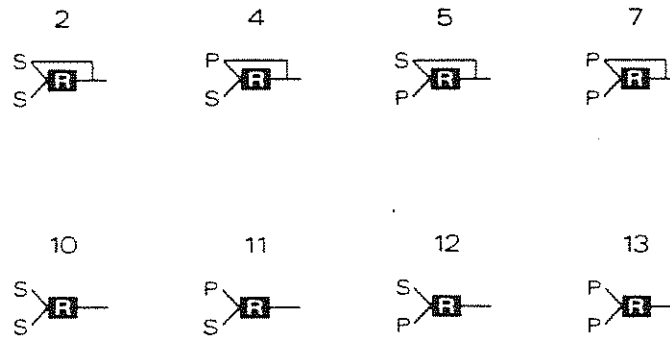

The Ring Modulator cross-modulates two Partial resulting in harmonics that are fractional multiples of the fundamental. The key points to using Ring Modulation are as follows.

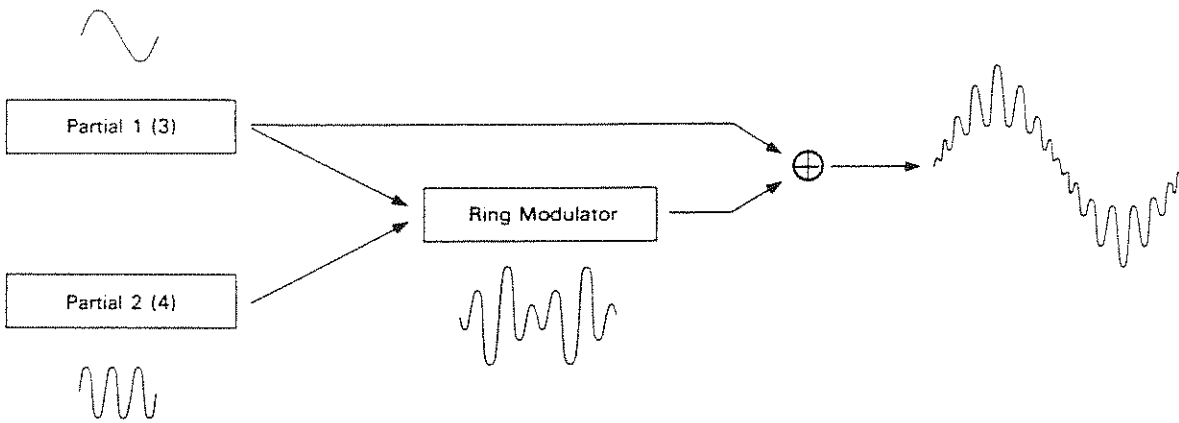

- When the output of either Partial is muted, the other Partial is automatically sent.
- Partial 1 (3) always behaves as a fundamental and Partial 2 (4) as harmonic content.
- Partial 1 (3) controls the overall volume.
- When the pitch ratio of Partial 2 (4) is a multiple of the fundamental, a clear sound is obtained. To create a transparent metallic sound, make Partial 1 (3) as near to a sine wave as possible.

PCM sounds normally include many odd multiple harmonics, and therefore can become too "muddy" when using the Ring Modulator. Do not set the TVA level of Partial 2 (4) too high.

b. The Editing Procedure

14

For easier and quicker editing, select a Tone which is similar to the sound you wish to make. Then set the D-20 to the Edit mode, and check the following points to study how the Partials are being used. If you roughly understand the structure of the Partials, you can tell which Partials should be edited.

☐ Check the Partial Mute

The Partial Mute is one of the parameters, therefore is written in memory together with other parameters. The muted Partial is not being used.

☐ Check how each Partial works

Using the Partial Mute function, listen to the sound of each Partial in use. You may pay attention to how sounds change depending on the sound range, or by the velocity. When using the Ring Modulator, muting one of the Partials will automatically output the other Partial.

☐ Check the Structure

Using the Structure number, you can check how each Partial functions and how the Partials are combined.

7 TROUBLE INFORMATION

1. Before calling for Service

The D-20 features so many functions that it may not always react as you expect. The cause may lie in the amplifier used, or something equally as simple. Before calling for service, please check the following.

No sound is heard or the volume is too low :

- Check if the volume is set too low.
- Check if you can hear sound through the headphones. If not, there is something wrong with the cords or external device.
- Check if the LOCAL (MIDI function) is set to OFF (in the Performance mode).
[See page 158.]
- Check if the keyboard transmit channel is set to the same number as the MIDI channel of the relevant Part (in the Multi Timbral mode).
[See page 10.]
- Check if the volume of the relevant Part is set too low (in the Multi Timbral mode).
[See page 15.]
- Check if the MIDI Volume messages sent from the external device which can receive MIDI Volume messages to the D-20 are not too low. This happens after performance data that contains MIDI Volume messages are played back, or MIDI Volume messages are recorded. If so, push the Mode Button twice to return the MIDI Volume to the maximum.

Rhythm sound is not heard :

- Check if the volume of the rhythm is set too low.
[See page 24 in the Volume 1.]
- Check if the Clock Mode is set to other than "MIDI".
[See page 165 in the Performance Mode]
[See page 171 in the Multi Timbral Mode]

No metronome sound is heard :

- Check if the volume of the metronome is set too low.
[See page 28 in the Volume 1.]
- Check if the Metronome mode is correctly set.
[See page 19.]

Pitch is not normal :

- Check if the Key Transpose has been altered.
[See page 32 in Volume 1, if in the Performance mode.]
[See page 16 in Volume 1, if in the Multi Timbral mode.]
 - Check if the Master Tuning is correct.
[See page 31 in the Volume 1, if in the Performance mode.]
[See page 13 if in the Multi Timbral mode.]
 - Check if the pitch has been changed by the Bender message from MIDI IN. If so, bend the Bender Lever.
- *If the pitch of a certain Patch/Timbre is strange, the cause will lie in the setting of that Patch/Timbre or Tone.

A Patch/Timbre cannot be selected :

- Check if the RHYTHM or SEQUENCER indicator is lit. If so, push the SYNTH button.
- Check if the D-20 is set to the Play mode. If it is set to any other mode such as to the Edit mode, push the EXIT button.

The effect of the Pan setting does not appear to be correct :

- Check if you are using a Tone made by one Partial. A Tone made by only one Partial has only 8 Pan steps.
- Check if the Structure of the Tone Parameters is set to 8 or 9. When the Structure is set to 8 or 9, each Partial has a different pan setting.
[See page 109.]

MIDI Messages are not correctly communicated :

○Check if the MIDI Functions on the receiver and transmitter are set correctly.

[See page 157 if in the Performance mode.]

[See page 9 if in the Multi Timbral mode.]

The Programmer does not seem to work properly :

○Check if the MIDI Unit numbers of the Programmer and the D-20 are set to the same number.

[See page 161 if in the Performance mode.]

[See page 11 if in the Multi Timbral mode.]

2. Error Messages

When there is something wrong with the procedure you have taken or the D-20 itself, an Error Message will be shown in the Display. If so, resolve it as follows.

*If the same error message is shown repeatedly even though there is no mistake in your operation, call your local Roland service center.

a. Error Messages shown during playing or recording

Card Not Ready

○The memory card is not securely connected. Insert it correctly.

Illegal Card

○You are using a brand new memory card or a memory card for other than the D-10, D-20 or D-110. Take the "Saving" procedure explained on page 189. (The D-110's memory card cannot be used in the Performance mode.)

MIDI Buffer Full

○You have tried to write data exceeding the memory capacity, turn the unit off once.

Error Messages shown when the battery is low

Check
Internal Battery

- The battery for memory backup of the D-20 is low. Call your local Roland service center.

Check
Card's Battery

- The battery for memory back of the optional memory card (M-256D, M-256E) is low. Replace the battery (CR2016) with a new one as explained in the instructions of the memory card.

Error Messages shown during recording

Memory Full

- Remaining memory capacity of the internal memory is too little for the data to be recorded into Track 1-8.

Meas Limit Over

- Since the memory capacity reaches the maximum (500 bars), no data can be recorded.

b. Error Messages shown during Writing or Data Transfer

Turn Protect off
once? Write/Exit

○The Memory Protect function on the D-20 is set to ON. To release the Protect function here, push the WRITE button, then the ENTER button. To leave the writing mode, push the EXIT button.

Error Messages related with Memory Cards

Insert Card

○No memory card is connected. Connect a memory card, then push the ENTER button. To leave this mode, push the EXIT button.

Card Protected

○The Memory Protect Switch on the memory card is set to the ON position. Set it to OFF, and push the ENTER button. To leave this mode, push the EXIT button.

Illegal Card

○You are using a brand new memory card or a memory card for other than the D-10 or D-20. Replace the card with a proper one, then push the ENTER button. If you wish to leave this mode, push the EXIT button.

Illegal Card
Enter

○You are using a brand new memory card or a memory card for other than the D-10 or D-20. Pushing the ENTER button will execute saving. If you wish to leave the saving mode, push the EXIT button.

Card Error
Exit

- The data is not properly written. Push the EXIT button, then repeat the procedure.

No Data

- The data, such as the data for loading the data of Patch from the memory card of D-110, is not saved on the memory card. Change the memory card, then push the Enter button. If you wish to leave this mode, push the EXIT button.

No Space

- You are trying to save the data which cannot be saved on the memory card, such as the data for saving the Rhythm Performance data or Patch data on memory card of D-110. Change the memory card, then push the Enter button. If you wish to leave this mode, push the EXIT button.

Error Messages related with Floppy Disks

Insert Disk

- No disk is connected. Insert a disk.
To leave this mode, push the EXIT button.

Disk Protected

- The Protect Tab on the disk is set to the ON position. Take the disk out, set it to OFF, then insert it again. To leave this mode, push the EXIT button.

Illegal Disk

- You are using a disk which is not formatted or a disk for other than the D-20.
If going to the formatting procedure from saving, push the ENTER button. (This will call the Formatting Display.) While loading or deleting, change disks then repeat the procedure. If you wish to leave this mode, push the EXIT button.

Disk Save Renew?
▲▲▲▲▲▲▲▲▲▲▲▲

- The similar kind of the data with the same File name is already saved on the disk. To save data without changing the File name, rewriting the previous data, push the ENTER Button. To retain the previous data, push the EXIT button, change the File name, then push the ENTER button.

Disk Full

- The remaining memory capacity is not sufficient for the File data to be saved. Delete an unneeded File or change the disk, then repeat the procedure.

No Name

- You are trying to save the data on the disk without the File name. Making the File name, then repeat the procedure.

No Data

- You are trying to load data from a disk that contains no data. Change the disk, then repeat the procedure.

```
Data Not Found
```

- The File you have assigned cannot be found because you had changed disks during loading or deleting. Change the disk, then repeat the procedure.

```
Disk Error      4
                Exit
```

- You are using an incorrect procedure. Push the EXIT button, then repeat the procedure. (If the same error message is shown repeatedly no matter how many times you have tried, the disk may be damaged, so immediately change the disk.)

```
Disk Error      1
                Exit
```

- The disk may be damaged because it was removed from the Disk Drive while it was running. Push the EXIT button, then check if the loading has been properly done.

```
Disk Error      5
                Exit
```

- The disk may be damaged because it was removed from the Disk Drive while it was running. Push the EXIT button, change the disk, then repeat the procedure. If you use the disk with the error message, format the disk. (If the disk cannot be formatted, do not use the disk any longer.)

Error numbers except
1, 4 or 5.



Disk Error	□
	Exit

- You are using an incorrect procedure. Push the EXIT button, then repeat the procedure carefully, (If the same error message is shown repeatedly no matter how many times you have tried, consult your local Roland service center.)

Error Messages related with MIDI

MIDI Communicat	
Error	Exit

- Data Transfer has not been correctly done. Push the EXIT button, check the connections, then repeat the Data Transfer procedure.

Data Mismatch	
	Exit

- Data setting on the receiver does not match the transmitter's. Push the EXIT button, then repeat the Data Transfer procedure.

7 APPENDIX TABLES

1. Tables

a. Performance Mode

Tune/Function		Value
Master Tune	*1	428 ... 453Hz
Memory Protect	*1*2	ON, OFF
Key Transpose	*1	-12 ... 0 ... +12

MIDI Function		Value
MIDI RxCH		1 ... 16
MIDI TxCH		1 ... 16
MIDI Rhythm CH	*1	1 ... 16
MIDI Local	*2	ON, OFF
MIDI Bender		ON, OFF
MIDI Modulation		ON, OFF
MIDI Rx Volume		ON, OFF
MIDI Hold		ON, OFF
MIDI Program Change		ON, OFF
MIDI Tx All Notes Off	*1*2	ON, OFF
MIDI Unit No.	*1*2	OFF, 17 ... 32
MIDI Patch Dump	*1*2	ON, OFF

*1 These parameters are available in the Multi Timbral Mode.

*2 These parameters are always set to the default values when the unit is turned on.

Memory Protect ON
 MIDI Local ON
 MIDI Tx All Notes OFF .. ON
 MIDI Unit No. 17
 MIDI Patch Dump OFF

Patch Parameter	Value
Key Mode	WHOLE, DUAL, SPLIT
Split Point	C2 ... C#7
Tone Select (Lower/Upper)	a1 ... 64, b1 ... 64 i (c) 1 ... 64, r1 ... 63, OFF
Key Shift (Lower/Upper)	-24 ... 0 ... +24
Fine Tune (Lower/Upper)	-50 ... 0 ... +50
Bender Range (Lower/Upper)	0 ... 24
Assign Mode (Lower/Upper)	1, 2, 3, 4
Reverb Switch (Lower/Upper)	ON, OFF
Reverb Type	1 : SMALL ROOM 2 : MEDIUM ROOM 3 : MEDIUM HALL 4 : LARGE HALL 5 : PLATE 6 : DELAY 1 7 : DELAY 2 8 : DELAY 3 OFF
Reverb Time	1 ... 8
Reverb Level	0 ... 7
Tone Balance Lower/Upper	0 ... 100
Patch Level	0 ... 100
Patch Name 16文字	Space, A ... Z, a ... z, 0 ... 9, & # ! ? . : ; ' " * + - / < = >

b. Multi Timbral Mode

Tune/Function	Value
Master Tune *1	428 ... 453Hz
Memory Protect *1*2	ON, OFF
Split Point	C2 ... C#7
Reverb Type	1 : SMALL ROOM 2 : MEDIUM ROOM 3 : MEDIUM HALL 4 : LARGE HALL 5 : PLATE 6 : DELAY 1 7 : DELAY 2 8 : DELAY 3 OFF
Reverb Time	1 ... 8
Reverb Level	0 ... 7
Part 1 ... 8 Pan Level	7 > ... < ... < 7 0 ... 100
Key Transpose *1	-12 ... 0 ... +12

MIDI Function	Value
MIDI Part RxCH (Part 1 ... 8)	1 ... 16
MIDI Rhythm Part CH *1	1 ... 16
MIDI Keyboard TxCH (Lower/Upper)	1 ... 16
MIDI Tx All Notes Off *1*2	ON, OFF
MIDI Unit No. *1*2	OFF, 17 ... 32
MIDI Timbre Dump *1*2	ON, OFF

Timbre Parameter	Value
Tone Select	a1 ... 64, b1 ... 64, i (c) 1 ... 64, r1 ... 63, OFF
Key Shift	-24 ... 0 ... +24
Fine Tune	-50 ... 0 ... +50
Bender Range	0 ... 24
Assign Mode	1, 2, 3, 4
Reverb Switch	ON, OFF

*1 These parameters are available in the Performance Mode.

*2 These parameters are always set to the default values when the unit is turned on.

Memory Protect ON

MIDI Tx All Notes Off .. ON

MIDI Unit No. 17

MIDI Patch Dump OFF

c. Tone Parameters

Parameter Group	PCM	Parameter	Value
Common	○	Tone Name (10 Letters)	SPACE, A ... Z, a ... z, 0 ... 9, & # ! ? . . . ; ' " * + - / < = >
		Structure 1&2	1 ... 13
		Structure 3&4	1 ... 13
		ENV Mode	NORMAL, NO SUSTAIN
WG Pitch/Mod (Partial 1/2/3/4)	○	Pitch Coarse	C1, C#1 ... C9
		Pitch Fine	-50 ... 0 ... +50
		Keyfollow (Pitch)	-1, -1/2, -1/4, 0, 1/8, 1/4, 3/8, 1/2, 5/8, 3/4, 7/8, 1, 5/4, 3/2, 2, s1, s2
		LFO Rate	0 ... 100
		LFO Depth	0 ... 100
		Modulation Sensitivity	0 ... 100
		Bender Switch	ON, OFF
WG Form (Partial 1/2/3/4)	×	Waveform	SQUARE, SAWTOOTH
	○	PCM Wave Bank	1, 2
		PCM Wave No.	1 ... 128
	×	Pulse Width	0 ... 100
		PW Velocity Sensitivity	-7 ... 0 ... +7
Pitch ENV (Partial 1/2/3/4)	○	ENV Depth	0 ... 10
		ENV Velocity Sensitivity	0 ... 3
		ENV Keyfollow (Time)	0 ... 4
Pitch ENV (Partial 1/2/3/4)	○	Time 1/2/3/4	0 ... 100
		Level 0/1/2/End	-50 ... 0 ... +50
TVF Frequency (Partial 1/2/3/4)	×	Cutoff Frequency	0 ... 100
		Resonance	0 ... 30
		Keyfollow (Frequency)	-1, -1/2, -1/4, 0, 1/8, 1/4, 3/8, 1/2, 5/8, 3/4, 7/8, 1, 5/4, 3/2, 2
		Bias Point	<A1 ... <C7, >A1 ... >C7
		Bias Level	-7 ... 0 ... +7
TVF ENV (Partial 1/2/3/4)	×	ENV Depth	0 ... 100
		ENV Depth Velocity Sensitivity	0 ... 100
		ENV Keyfollow (Depth)	0 ... 4
TVF ENV (Partial 1/2/3/4)	×	ENV Keyfollow (Time)	0 ... 4
		Time 1/2/3/4	0 ... 100
		Level 1/2/Sustain	0 ... 100
TVA Level (Partial 1/2/3/4)	○	Level	0 ... 100
		Velocity Sencitivity	-50 ... 0 ... +50
		Bias Point 1	<A1 ... <C7, >A1 ... >C7
		Bias Level 1	-12 ... 0
		Bias Point 2	<A1 ... <C7, >A1 ... >C7
		Bias Level 2	-12 ... 0
		ENV Velocity Follow (T1)	0 ... 4
TVA ENV (Partial 1/2/3/4)	○	ENV Keyfollow (Time)	0 ... 4
		Time 1/2/3/4	0 ... 100
		Level 1/2/Sustain	0 ... 100

*The Partial Mute status is shown in the Number (5-8) Button's Indicator.

d. PCM Sounds

Bank 1

No.	PCM Name	Remarks
1	Bass Drum-1	Rhythm Sound
2	Bass Drum-2	
3	Bass Drum-3	
4	Snare Drum-1	
5	Snare Drum-2	
6	Snare Drum-3	
7	Snare Drum-4	
8	Tom Tom-1	
9	Tom Tom-2	
10	High-Hat	
11	High-Hat (Loop)	
12	Crash Cymbal-1	
13	Crash Cymbal-2 (Loop)	
14	Ride Cymbal-1	
15	Ride Cymbal-2 (Loop)	
16	Cup	
17	China Cymbal-1	
18	China Cymbal-2 (Loop)	
19	Rim Shot	
20	Hand Clap	
21	Mute High Conga	
22	Conga	
23	Bongo	
24	Cowbell	
25	Tambourine	
26	Agogo	
27	Claves	
28	Timbale High	
29	Timbale Low	
30	Cabasa	
31	Timpani Attack	Attack Sound
32	Timpani	
33	Acoustic Piano High	
34	Acoustic Piano Low	
35	Piano Forte Thump	
36	Organ Percussion	
37	Trumpet	
38	Lips	
39	Trombone	
40	Clarinet	
41	Flute High	
42	Flute Low	
43	Steamer	
44	Indian Flute	
45	Breath	
46	Vibraphone High	
47	Vibraphone Low	
48	Marimba	
49	Xylophone High	
50	Xylophone Low	
51	Kalimba	
52	Wind Bell	
53	Chime Bar	
54	Hammer	
55	Guiro	
56	Chink	
57	Nails	
58	Fretless Bass	
59	Pull Bass	
60	Slap Bass	
61	Thump Bass	
62	Acoustic Bass	
63	Electric Bass	
64	Gut Guitar	

No.	PCM Name	Remarks
65	Steel Guitar	
66	Dirty Guitar	
67	Pizzicato	
68	Harp	
69	Contrabass	
70	Cello	
71	Violin-1	
72	Violin-2	
73	Koto	
74	Draw bars (Loop)	Sustained Sound ⁴
75	High Organ (Loop)	
76	Low Organ (Loop)	
77	Trumpet (Loop)	
78	Trombone (Loop)	
79	Sax-1 (Loop)	
80	Sax-2 (Loop)	
81	Reed (Loop)	
82	Slap Bass (Loop)	
83	Acoustic Bass (Loop)	
84	Electric Bass-1 (Loop)	
85	Electric Bass-2 (Loop)	
86	Gut Guitar (Loop)	
87	Steel Guitar (Loop)	
88	Electric Guitar (Loop)	
89	Clav (Loop)	
90	Cello (Loop)	
91	Violin (Loop)	
92	Electric Piano-1 (Loop)	
93	Electric Piano-2 (Loop)	
94	Harpsichord-1 (Loop)	
95	Harpsichord-2 (Loop)	
96	Telephone Bell (Loop)	
97	Female Voice-1 (Loop)	
98	Female Voice-2 (Loop)	
99	Male Voice-1 (Loop)	
100	Male Voice-2 (Loop)	
101	Spectrum-1 (Loop)	
102	Spectrum-2 (Loop)	
103	Spectrum-3 (Loop)	
104	Spectrum-4 (Loop)	
105	Spectrum-5 (Loop)	
106	Spectrum-6 (Loop)	
107	Spectrum-7 (Loop)	
108	Spectrum-8 (Loop)	
109	Spectrum-9 (Loop)	
110	Spectrum-10 (Loop)	
111	Noise (Loop)	
112	Shot-1	Decay Sound
113	Shot-2	
114	Shot-3	
115	Shot-4	
116	Shot-5	
117	Shot-6	
118	Shot-7	
119	Shot-8	
120	Shot-9	
121	Shot-10	
122	Shot-11	
123	Shot-12	
124	Shot-13	
125	Shot-14	
126	Shot-15	
127	Shot-16	
128	Shot-17	

Bank 2

No.	PCM Name	Remarks
1	Bass Drum-1*	Rhythm Sound (The pitch is not affected by Master Tuning.)
2	Bass Drum-2*	
3	Bass Drum-3*	
4	Snare Drum-1*	
5	Snare Drum-2*	
6	Snare Drum-3*	
7	Snare Drum-4*	
8	Tom Tom-1*	
9	Tom Tom-2*	
10	High-Hat*	
11	High-Hat* (Loop)	
12	Crash Cymbal-1*	
13	Crash Cymbal-2* (Loop)	
14	Ride Cymbal-1*	
15	Ride Cymbal-2* (Loop)	
16	Cup*	
17	China Cymbal-1*	
18	China Cymbal-2* (Loop)	
19	Rim Shot*	
20	Hand Clap*	
21	Mute High Conga*	
22	Conga*	
23	Bongo*	
24	Cowbell*	
25	Tambourine*	
26	Agogo*	
27	Claves*	
28	Timbale High*	
29	Timbale Low*	
30	Cabasa*	
31	Loop-1	Effect Sound (Repeats of the same sound.)
32	Loop-2	
33	Loop-3	
34	Loop-4	
35	Loop-5	
36	Loop-6	
37	Loop-7	
38	Loop-8	
39	Loop-9	
40	Loop-10	
41	Loop-11	
42	Loop-12	
43	Loop-13	
44	Loop-14	
45	Loop-15	
46	Loop-16	
47	Loop-17	
48	Loop-18	
49	Loop-19	
50	Loop-20	
51	Loop-21	
52	Loop-22	
53	Loop-23	
54	Loop-24	
55	Loop-25	
56	Loop-26	
57	Loop-27	
58	Loop-28	
59	Loop-29	
60	Loop-30	
61	Loop-31	
62	Loop-32	
63	Loop-33	
64	Loop-34	

No.	PCM Name	Remarks
65	Loop-35	
66	Loop-36	
67	Loop-37	
68	Loop-38	
69	Loop-39	
70	Loop-40	
71	Loop-41	
72	Loop-42	
73	Loop-43	
74	Loop-44	
75	Loop-45	
76	Loop-46	
77	Loop-47	
78	Loop-48	
79	Loop-49	
80	Loop-50	
81	Loop-51	
82	Loop-52	
83	Loop-53	
84	Loop-54	
85	Loop-55	
86	Loop-56	
87	Loop-57	
88	Loop-58	
89	Loop-59	
90	Loop-60	
91	Loop-61	
92	Loop-62	
93	Loop-63	
94	Loop-64	
95	Jam-1 (Loop)	Effect Sound (Repeats of combined sounds)
96	Jam-2 (Loop)	
97	Jam-3 (Loop)	
98	Jam-4 (Loop)	
99	Jam-5 (Loop)	
100	Jam-6 (Loop)	
101	Jam-7 (Loop)	
102	Jam-8 (Loop)	
103	Jam-9 (Loop)	
104	Jam-10 (Loop)	
105	Jam-11 (Loop)	
106	Jam-12 (Loop)	
107	Jam-13 (Loop)	
108	Jam-14 (Loop)	
109	Jam-15 (Loop)	
110	Jam-16 (Loop)	
111	Jam-17 (Loop)	
112	Jam-18 (Loop)	
113	Jam-19 (Loop)	
114	Jam-20 (Loop)	
115	Jam-21 (Loop)	
116	Jam-22 (Loop)	
117	Jam-23 (Loop)	
118	Jam-24 (Loop)	
119	Jam-25 (Loop)	
120	Jam-26 (Loop)	
121	Jam-27 (Loop)	
122	Jam-28 (Loop)	
123	Jam-29 (Loop)	
124	Jam-30 (Loop)	
125	Jam-31 (Loop)	
126	Jam-32 (Loop)	
127	Jam-33 (Loop)	
128	Jam-34 (Loop)	

APPENDIX TABLES

e. Preset Rhythm Tones

No.	Tone Name	Number of Partials
r01	Closed High Hat-1	1
r02	Closed High Hat-2	1
r03	Open High Hat-1	2
r04	Open High Hat-2	2
r05	Crash Cymbal	2
r06	Crash Cymbal (short)	1
r07	Crash Cymbal (mute)	1
r08	Ride Cymbal	2
r09	Ride Cymbal (short)	1
r10	Ride Cymbal (mute)	1
r11	Cup	2
r12	Cup (mute)	1
r13	China Cymbal	2
r14	Splash Cymbal	1
r15	Bass Drum-1	2
r16	Bass Drum-2	1
r17	Bass Drum-3	2
r18	Bass Drum-4	1
r19	Snare Drum-1	1
r20	Snare Drum-2	1
r21	Snare Drum-3	1
r22	Snare Drum-4	2
r23	Snare Drum-5	1
r24	Snare Drum-6	1
r25	Rim Shot	1
r26	Brush-1	2
r27	Brush-2	2
r28	High Tom Tom-1	1
r29	Middle Tom Tom-1	1
r30	Low Tom Tom-1	1
r31	High Tom Tom-2	1
r32	Middle Tom Tom-2	1
r33	Low Tom Tom-2	1
r34	High Tom Tom-3	2
r35	Middle Tom Tom-3	2
r36	Low Tom Tom-3	2
r37	High Pitch Tom Tom-1	1
r38	High Pitch Tom Tom-2	1
r39	Hand Clap	1
r40	Tambourine	1
r41	Cowbell	1
r42	High Bongo	1
r43	Low Bongo	1
r44	High Conga (mute)	1
r45	High Conga	1
r46	Low Conga	1
r47	High Timbale	1
r48	Low Timbale	1
r49	High Agogo	1
r50	Low Agogo	1
r51	Cabasa	1
r52	Maracas	1
r53	Short Whistle	2
r54	Long Whistle	2
r55	Quijada	3
r56	Claves	1
r57	Castanets	2
r58	Triangle	2
r59	Wood Block	1
r60	Bell	2
r61	Native Drum-1	1
r62	Native Drum-2	1
r63	Native Drum-3	1
OFF		0

f. Preprogrammed Rhythm Setup

r63	Native Drum-3	
r62	Native Drum-2	C7
r61	Native Drum-1	
r09	Ride Cymbal (short)	
r34	High Tom Tom-3	
r06	Crash Cymbal (short)	
r35	Middle Tom Tom-3	
r02	Closed High Hat-2	
r36	Low Tom Tom-3	
r24	Snare Drum-6	
r23	Snare Drum-5	
r22	Snare Drum-4	
r18	Bass Drum-4	C6
r17	Bass Drum-3	
r60	Bell	
r59	Wood Block	
r37	High Pitch Tom Tom-1	
r58	Triangle	
r38	High Pitch Tom Tom-2	
r57	Castanets	
r27	Brush-2	
r26	Brush-1	
r56	Claves	
r12	Cup (mute)	
r55	Quijada	C5
r54	Long Whistle	
r53	Short Whistle	
r52	Maracas	
r51	Cabasa	
r50	Low Agogo	
r49	High Agogo	
r48	Low Timbale	
r47	High Timbale	
r46	Low Conga	
r45	High Conga	
r44	High Conga (mute)	
r43	Low Bongo	C4 (Middle C)
r42	High Bongo	
r10	Ride Cymbal (mute)	
r21	Snare Drum-3	
r07	Crash Cymbal (mute)	
r41	Cowbell	
r14	Splash Cymbal	
r40	Tambourine	
r11	Cup	
r13	China Cymbal	
r08	Ride Cymbal	
r31	High Tom Tom-2	
r05	Crash Cymbal	C3
r28	High Tom Tom-1	
r32	Middle Tom Tom-2	
r03	Open High Hat-1	
r29	Middle Tom Tom-1	
r04	Open High Hat-2	
r33	Low Tom Tom-2	
r01	Closed High Hat-1	
r30	Low Tom Tom-2	
r20	Snare Drum-2	
r39	Hand Clap	
r19	Snare Drum-1	
r25	Rim Shot	C2
r16	Bass Drum-2	
r15	Bass Drum-1	

g. Preset Tones

a Group

No.	Tone Name	Number of Partials
01	AcouPiano1	3
02	AcouPiano2	2
03	AcouPiano3	2
04	Honky-Tonk	3
05	ElecPiano1	3
06	ElecPiano2	3
07	ElecPiano3	2
08	ElecPiano4	1
09	ElecOrgan1	4
10	ElecOrgan2	2
11	ElecOrgan3	2
12	ElecOrgan4	1
13	PipeOrgan1	3
14	PipeOrgan2	3
15	PipeOrgan3	2
16	Accordion	2
17	Harpsi 1	3
18	Harpsi 2	2
19	Harpsi 3	1
20	Clav 1	3
21	Clav 2	2
22	Clav 3	2
23	Celesta 1	3
24	Celesta 2	2
25	Violin 1	3
26	Violin 2	2
27	Cello 1	3
28	Cello 2	2
29	Contrabass	2
30	Pizzicato	3
31	Harp 1	3
32	Harp 2	2
33	Strings 1	4
34	Strings 2	3
35	Strings 3	2
36	Strings 4	3
37	Brass 1	4
38	Brass 2	3
39	Brass 3	4
40	Brass 4	4
41	Trumpet 1	3
42	Trumpet 2	2
43	Trombone 1	3
44	Trombone 2	2
45	Horn	3
46	Fr Horn	2
47	Engl Horn	2
48	Tuba	2
49	Flute 1	4
50	Flute 2	2
51	Piccolo	3
52	Recorder	2
53	Pan Pipes	3
54	Bottleblow	4
55	Breathpipe	4
56	Whistle	2
57	Sax 1	2
58	Sax 2	2
59	Sax 3	2
60	Clarinet 1	2
61	Clarinet 2	3
62	Oboe	3
63	Bassoon	2
64	Harmonica	2

b Group

No.	Tone Name	Number of Partials
01	Fantasy	4
02	Harmo Pan	4
03	Chorale	3
04	Glasses	3
05	Soundtrack	4
06	Atmosphere	4
07	Warm Bell	4
08	Space Horn	4
09	Echo Bell	3
10	Ice Rains	4
11	Oboe 2002	2
12	Echo Pan	2
13	Bell Swing	3
14	Reso Synth	2
15	Steam Pad	3
16	VibeString	4
17	Syn Lead 1	4
18	Syn Lead 2	2
19	Syn Lead 3	3
20	Syn Lead 4	2
21	Syn Bass 1	3
22	Syn Bass 2	2
23	Syn Bass 3	2
24	Syn Bass 4	3
25	AcouBass 1	2
26	AcouBass 2	1
27	ElecBass 1	2
28	ElecBass 2	2
29	SlapBass 1	2
30	SlapBass 2	3
31	Fretless 1	4
32	Fretless 2	2
33	Vibe	2
34	Glock	3
35	Marimba	3
36	Xylophone	2
37	Guitar 1	3
38	Guitar 2	3
39	Elec Gtr 1	4
40	Elec Gtr 2	4
41	Koto	2
42	Shamisen	2
43	Jamisen	2
44	Sho	4
45	Shakuhachi	4
46	WadaikoSet	4
47	Sitar	4
48	Steel Drum	4
49	Tech Snare	4
50	Elec Tom	4
51	Revrse Cym	2
52	Ethno Hit	4
53	Timpani	2
54	Triangle	2
55	Wind Bell	3
56	Tube Bell	4
57	Orche Hit	4
58	Bird Tweet	1
59	OneNoteJam	4
60	Telephone	1
61	Typewriter	2
62	Insect	2
63	WaterBells	3
64	JungleTune	4

h. Others

Rhythm/Metronome Function

Function	Value
Tempo	40 ... 250 (2 step unit)
Rhythm Level	0 ... 100
Metronome Level	0 ... 100
Metronome Beat	0 ... 8
Metronome Mode	OFF, Rec Only, Rec&Play
Clock Mode	INTERNAL, MIDI

Rhythm Setup Key Number (C1 ... C8)

Parameter	Value
Tone Select	r1 ... 63, OFF, i1 ... 64
Level	0 ... 100
Pan	7> ... < ... <7
Reverb Switch	ON, OFF

Request data RQD 41H

When the RQD received contains start address listed in the Parameter base address table; and the address size is 1 or more, D-20 sends the data stored in that and subsequent address locations, if any.

Byte	Description
FDH	Exclusive status
41H	Manufactures ID (Roland)
DEV	Device ID
16H	Model ID
41H	Command ID
aaH	Address MSB *7-1
asH	Address
aaH	Address LSB
asH	Size MSB
asH	Size
asH	Size LSB
sum	Check sum
F7H	End of exclusive

Data set DAT 42H

When the DAT received contains address listed in the Parameter base address table, D-20 stores the data into that address location.

Byte	Description
FDH	Exclusive status
41H	Manufactures ID (Roland)
DEV	Device ID
16H	Model ID
42H	Command ID
aaH	Address MSB *7-1
asH	Address
aaH	Address LSB
ddH	Data *7-2
:	:
sum	Check sum
F7H	End of exclusive

Acknowledge ACK 43H

Upon receiving this message in reply to DAT, D-20 sends the next data; when receives in reply to EOD, ceases current handshaking communication. D-20 sends this message upon receipt of WSD or DAT.

Byte	Description
FDH	Exclusive status
41H	Manufactures ID (Roland)
DEV	Device ID
16H	Model ID
43H	Command ID
F7H	End of exclusive

End of data EOD 45H

Upon receipt of this message, D-20 sends acknowledge and terminates the current handshaking communication.

Byte	Description
FDH	Exclusive status
41H	Manufactures ID (Roland)
DEV	Device ID
16H	Model ID
45H	Command ID
F7H	End of exclusive

Communication error ERR 4EH

Should failure in data reception occur (e.g. disagreement of checksum), D-20 sends this message. If D-20 receives this message, it sends the last message again.

Byte	Description
FDH	Exclusive status
41H	Manufactures ID (Roland)
DEV	Device ID
16H	Model ID
4EH	Command ID
F7H	End of exclusive

Rejection RJC 4FH

D-20 ends communication upon receipt of this message.

Byte	Description
FDH	Exclusive status
41H	Manufactures ID (Roland)
DEV	Device ID
16H	Model ID
4FH	Command ID
F7H	End of exclusive

- *7-1 Address and size must specify the address where data exist.
- *7-2 If the receiving data are system partial parameters, D-20 recognizes these data only after it has received all the partial reserve parameters (See *8-8 System area.)

E. PARAMETER ADDRESS MAP

Addresses are shown in 7-bit hexadecimal.

Address	MSB	LSB
Binary	0aaa aaas	0bbb bbbb
7-bit hex.	AA	BB CC

The actual address of a parameter in a block is the sum of the start address each block and one or more offset address. Parameters marked by *8-1 have two offset addresses: one in the table in *7-1 and the other one in the Common parameter table or in the Partial parameter table.

Parameter base address

Temporary area (Accessible on each basic channel)

Start address	Description		
00 00 00	Timbre Temporary Area	(synth part)	*8-3
01 00 00	Setup Temporary Area	(rhythm part)	*8-2
02 00 00	Tone Temporary Area	(synth part)	*8-1

Whole part (Accessible on UNIT#)

Start address	Description		
03 00 00	Timbre Temporary Area	(part 1)	*8-3
03 00 10	Timbre Temporary Area	(part 2)	
:	:	:	
03 00 60	Timbre Temporary Area	(part 7)	
03 00 70	Timbre Temporary Area	(part 8)	
03 01 00	Timbre Temporary Area	(rhythm part)	
03 01 10	Rhythm Setup Temporary Area		*8-2
03 04 00	Patch Temporary Area		*8-4
04 00 00	Tone Temporary Area	(part 1/upper)	*8-1
04 01 76	Tone Temporary Area	(part 2/lower)	
:	:	:	
04 0B 44	Tone Temporary Area	(part 7)	
04 0D 3A	Tone Temporary Area	(part 8)	
05 00 00	Timbre Memory #1		*8-5
05 00 08	Timbre Memory #2		
:	:	:	
05 07 70	Timbre Memory #127		
05 07 78	Timbre Memory #128		
07 00 00	Patch Memory #1		*8-4
07 00 26	Patch Memory #2		
:	:	:	
07 25 34	Patch Memory #127		
07 25 5A	Patch Memory #128		
08 00 00	Tone Memory #1		*8-1
08 02 00	Tone Memory #2		
:	:	:	
08 7C 00	Tone Memory #63		
08 7E 00	Tone Memory #64		
09 00 00	Rhythm Setup #1		*8-2
09 00 04	Rhythm Setup #2		
:	:	:	
09 02 4C	Rhythm Setup #84		
09 02 50	Rhythm Setup #85		
0A 00 00	Rhythm Pattern P-51		*8-6
0A 04 4C	Rhythm Pattern P-52		
:	:	:	
0B 09 68	Rhythm Pattern P-87		
0B 0E 34	Rhythm Pattern P-88		
0C 00 00	Rhythm Track		*8-7
10 00 00	System Area		*8-8
20 00 00	Display		*8-9
40 00 00	Write Request		*8-10

Notes :

*8-1 Tone Temporary area/Tone Memory

Start address	Description	
00 00 00	Common parameter	*8-1-1
00 00 0E	Partial parameter (for Partial# 1)	*8-1-2
00 00 48	Partial parameter (for Partial# 2)	
00 01 02	Partial parameter (for Partial# 3)	
00 01 3C	Partial parameter (for Partial# 4)	

Total size = 00 01 76H

*8-1-1 Common parameter

Offset address	Description	
00H	TONE NAME 1	32-127 (ASCII)
09H	TONE NAME 10	
0AH	Structure of Partial# 1&2	0-12 (1-13)
0BH	Structure of Partial# 3&4	0-12 (1-13)
0CH	PARTIAL MUTE	0-15 (0000-1111)
0DH	ENV MODE	0-1 (Normal, No sustain)

Total size = 00 00 0EH

*8-1-2 Partial parameter

Offset address	Description	
00 00H	WG PITCH COARSE	0-96 (C1-C9)
00 01H	WG PITCH FINE	0-100 (-50-+50)
00 02H	WG PITCH KEYFOLLOW	0-16 (-1, -1/2, -1/4, 0, 1/8, 1/4, 3/8, 1/2, 5/8, 3/4, 7/8, 1, 5/4, 3/2, 2, s1, s2)
00 03H	WG PITCH BENDER SW	0-1 (OFF, ON)
00 04H	WG WAVEFORM/PCM BANK	0-3 (SQU/1, SAW/1, SQU/2, SAW/2)
00 05H	WG PCM WAVE #	0-127 (1-128)
00 06H	WG PULSE WIDTH	0-100
00 07H	WG PW VELO SENS	0-14 (-7-+7)
00 08H	P-ENV DEPTH	0-10
00 09H	P-ENV VELO SENS	0-3
00 0AH	P-ENV TIME KEYF	0-4
00 0BH	P-ENV TIME 1	0-100
00 0CH	P-ENV TIME 2	0-100
00 0DH	P-ENV TIME 3	0-100
00 0EH	P-ENV TIME 4	0-100
00 0FH	P-ENV LEVEL 0	0-100 (-50-+50)
00 10H	P-ENV LEVEL 1	0-100 (-50-+50)
00 11H	P-ENV LEVEL 2	0-100 (-50-+50)
00 12H	dummy (for MT-32)	
00 13H	END LEVEL	0-100 (-50-+50)
00 14H	P-LFO RATE	0-100
00 15H	P-LFO DEPTH	0-100
00 16H	P-LFO MOD SENS	0-100
00 17H	TVF CUTOFF FREQ	0-100
00 18H	TVF RESONANCE	0-30
00 19H	TVF KEYFOLLOW	0-14 (-1, -1/2, -1/4, 0, 1/8, 1/4, 3/8, 1/2, 5/8, 3/4, 7/8, 1, 5/4, 3/2, 2)
00 1AH	TVF BIAS POINT	0-127 (<1A-<7C >1A->7C)
00 1BH	TVF BIAS LEVEL	0-14 (-7-+7)
00 1CH	TVF ENV DEPTH	0-100
00 1DH	TVF ENV VELO SENS	0-100
00 1EH	TVF ENV DEPTH KEYF	0-4
00 1FH	TVF ENV TIME KEYF	0-4
00 20H	TVF ENV TIME 1	0-100
00 21H	TVF ENV TIME 2	0-100
00 22H	TVF ENV TIME 3	0-100
00 23H	dummy (for MT-32)	
00 24H	TVF ENV TIME 4	0-100
00 25H	TVF ENV LEVEL 1	0-100
00 26H	TVF ENV LEVEL 2	0-100
00 27H	dummy (for MT-32)	
00 28H	TVF ENV SUSTAIN LEVEL	0-100
00 29H	TVA LEVEL	0-100
00 2AH	TVA VELO SENS	0-100 (-50-+50)

00 2BH	TVA BIAS POINT 1	0-127 (<1A-<7C >1A->7C)
00 2CH	TVA BIAS LEVEL 1	0-12 (-12-0)
00 2DH	TVA BIAS POINT 2	0-127 (<1A-<7C >1A->7C)
00 2EH	TVA BIAS LEVEL 2	0-12
00 2FH	TVA ENV TIME KEYF	0-4
00 30H	TVA ENV TIME V-FOLLOW	0-4
00 31H	TVA ENV TIME 1	0-100
00 32H	TVA ENV TIME 2	0-100
00 33H	TVA ENV TIME 3	0-100
00 34H	dummy (for MT-32)	
00 35H	TVA ENV TIME 4	0-100
00 36H	TVA ENV LEVEL 1	0-100
00 37H	TVA ENV LEVEL 2	0-100
00 38H	dummy (for MT-32)	
00 39H	TVA ENV SUSTAIN LEVEL	0-100

Total size = 00 00 3AH

Example of RQ1 and DT1 application... 1

Unit number is set at 17 in this example.

Sending the following data string lets D-20 send Part 2/Lower tone data from the temporary area.

FD 41 10 16 11 04 01 76 00 01 76 0E F7

*8-2 Rhythm Setup

Offset address	Description	
00 00H	TONE	0-127 (101-164, r01-r63, OFF)
00 01H	OUTPUT LEVEL	0-100
00 02H	PANPOT	0-14 (L-R)
00 03H	REVERB SWITCH	0-1 (OFF, ON)

Total size = 00 00 04H

*8-3 Timbre temporary area

D-20 accepts the data for the area below only in Multi timbral mode.

Offset address	Description	
00 00H	TONE GROUP	0-3 (a, b, i, r)
00 01H	TONE NUMBER	0-63 (1-64)
00 02H	KEY SHIFT	0-48 (-24-+24)
00 03H	FINE TUNE	0-100 (-50-+50)
00 04H	BENDER RANGE	0-24
00 05H	ASSIGN MODE	0-3 (POLY1, POLY2, POLY3, POLY4)
00 06H	REVERB SWITCH	0-1 (OFF, ON)
00 07H	dummy (ignored if received)	
00 08H	OUTPUT LEVEL	0-100
00 09H	PANPOT	0-14 (L-R)
00 0AH	dummy (ignored if received)	
00 0BH	dummy	

Total size = 00 00 10H

*8-4 Patch Temporary area/ Patch Memory

D-20 accepts the data for Patch temporary area only in Performance mode.

Offset address	Description	
00 00H	KEY MODE	0-2 (whole, dual, split)
00 01H	SPLIT POINT	0-61 (C2-C#7)
00 02H	LOWER TONE GROUP	0-3 (a, b, i, r)

b. Tones

Tone No. _____

Tone Name _____

Used Patch No. _____ Used Timbre No. _____

Structure 1&2	Structure 3&4	ENV Mode	
---------------	---------------	----------	--

WG		1	2	3	4
Pitch	Coarse				
	Fine				
	KF				
LFO	Rate				
	Depth				
	Mod				
Waveform	Bend				
	Form				
	PCM B				
	PCM No				
PW	PW				
	Velo				
Pitch ENV	Depth				
	Velo				
	TKF				
	T 1				
	T 2				
	T 3				
	T 4				
	L 0				
	L 1				
	L 2				
	End L				

TVF		1	2	3	4
TVF Frequency	Freq				
	Reso				
	KF				
	BP				
	BL				
TVF ENV	Depth				
	DVelo				
	DKF				
	TKF				
	T 1				
	T 2				
	T 3				
	T 4				
	L 1				
	L 2				
Sus L					

TVA		1	2	3	4
TVA Level	Level				
	Velo				
	BP 1				
	BL 1				
	BP 2				
TVA ENV	BL 2				
	Velo T 1				
	TKF				
	T 1				
	T 2				
	T 3				
	T 4				
	L 1				
L 2					
Sus L					

2. Sample Notes

Patch No. _____

Patch No. _____

Patch No. _____

Patch Name _____

Patch Name _____

Patch Name _____

Key Mode	
Split Point	
Reverb Type	
Reverb Time	
Reverb Level	
Tone Balance	
Patch Level	

Key Mode	
Split Point	
Reverb Type	
Reverb Time	
Reverb Level	
Tone Balance	
Patch Level	

Key Mode	
Split Point	
Reverb Type	
Reverb Time	
Reverb Level	
Tone Balance	
Patch Level	

	Lower	Upper
Tone Select		
Key Shift		
Fine Tune		
Bender Range		
Assign Mode		
Reverb Switch		

	Lower	Upper
Tone Select		
Key Shift		
Fine Tune		
Bender Range		
Assign Mode		
Reverb Switch		

	Lower	Upper
Tone Select		
Key Shift		
Fine Tune		
Bender Range		
Assign Mode		
Reverb Switch		

Timbre No. _____

Timbre No. _____

Timbre No. _____

Tone Select	
Key Shift	
Fine Tune	
Bender Range	
Assign Mode	
Reverb Switch	

Tone Select	
Key Shift	
Fine Tune	
Bender Range	
Assign Mode	
Reverb Switch	

Tone Select	
Key Shift	
Fine Tune	
Bender Range	
Assign Mode	
Reverb Switch	

Timbre No. _____

Timbre No. _____

Timbre No. _____

Tone Select	
Key Shift	
Fine Tune	
Bender Range	
Assign Mode	
Reverb Switch	

Tone Select	
Key Shift	
Fine Tune	
Bender Range	
Assign Mode	
Reverb Switch	

Tone Select	
Key Shift	
Fine Tune	
Bender Range	
Assign Mode	
Reverb Switch	

Roland Exclusive Messages

1 Data Format for Exclusive Messages

Roland's MIDI implementation uses the following data format for all exclusive messages (type IV):

Byte	Description
F0H	Exclusive status
41H	Manufacturer ID (Roland)
DEV	Device ID
MDL	Model ID
CMD	Command ID
[BODY]	Main data
F7H	End of exclusive

MIDI status : F0H, F7H

An exclusive message must be flanked by a pair of status codes, starting with a Manufacturer-ID immediately after F0H (MIDI version 1.0).

Manufacturer-ID : 41H

The Manufacturer-ID identifies the manufacturer of a MIDI instrument that triggers an exclusive message. Value 41H represents Roland's Manufacturer-ID.

Device-ID : DEV

The Device-ID contains a unique value that identifies the individual device in the multiple implementation of MIDI instruments. It is usually set to 00H - 0FH, a value smaller by one than that of a basic channel, but value 00H - 1FH may be used for a device with multiple basic channels.

Model-ID : MDL

The Model-ID contains a value that uniquely identifies one model from another. Different models, however, may share an identical Model-ID if they handle similar data.

The Model-ID format may contain 00H in one or more places to provide an extended data field. The following are examples of valid Model-IDs, each representing a unique model:

01H
02H
03H
00H, 01H
00H, 02H
00H, 00H, 01H

Command-ID : CMD

The Command-ID indicates the function of an exclusive message. The Command-ID format may contain 00H in one or more places to provide an extended data field. The following are examples of valid Command-IDs, each representing a unique function:

01H
02H
03H
00H, 01H
00H, 02H
00H, 00H, 01H

Main data : BODY

This field contains a message to be exchanged across an interface. The exact data size and contents will vary with the Model-ID and Command-ID.

2 Address-mapped Data Transfer

Address mapping is a technique for transferring messages conforming to the data format given in Section 1. It assigns a series of memory-resident records -- waveform and tone data, switch status, and parameters, for example -- to specific locations in a machine-dependent address space, thereby allowing access to data residing at the address a message specifies.

Address-mapped data transfer is therefore independent of models and data categories. This technique allows use of two different transfer procedures: one-way transfer and handshake transfer.

One-way transfer procedure (See Section 3 for details.)

This procedure is suited for the transfer of a small amount of data. It sends out an exclusive message completely independent of a receiving device status.

Connection Diagram

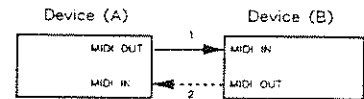

Connection at point 2 is essential for "Request data" procedures. (See Section 3.)

Handshake-transfer procedure (See Section 4 for details.)

This procedure initiates a predetermined transfer sequence (handshaking) across the interface before data transfer takes place. Handshaking ensures that reliability and transfer speed are high enough to handle a large amount of data.

Connection Diagram

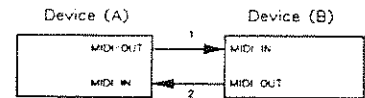

Connection at points 1 and 2 is essential.

Notes on the above two procedures

- * There are separate Command-IDs for different transfer procedures.
- * Devices A and B cannot exchange data unless they use the same transfer procedure, share identical Device-ID and Model ID, and are ready for communication.

3 One-way Transfer Procedure

This procedure sends out data all the way until it stops when the messages are so short that answerbacks need not be checked.

For long messages, however, the receiving device must acquire each message in time with the transfer sequence, which inserts intervals of at least 20 milliseconds in between.

Types of Messages

Message	Command ID
Request data 1	RQ1 (11H)
Data set 1	DT1 (12H)

Request data # 1 : RQ1 (11H)

This message is sent out when there is a need to acquire data from a device at the other end of the interface. It contains data for the address and size that specify designation and length, respectively, of data required.

On receiving an RQ1 message, the remote device checks its memory for the data address and size that satisfy the request.

If it finds them and is ready for communication, the device will transmit a "Data set 1 (DT1)" message, which contains the requested data. Otherwise, the device will send out nothing.

Byte	Description
F0H	Exclusive status
41H	Manufacturer ID (Roland)
DEV	Device ID
MDL	Model ID
11H	Command ID
aaH	Address MSB
⋮	⋮
⋮	⋮
⋮	LSB
56H	Size MSB
⋮	⋮
⋮	⋮
⋮	LSB
sum	Check sum
F7H	End of exclusive

c. Rhythm Setup

Ch	Dr	Org	Lead	Reverb
C 1 (24)				
C#1 (25)				
D 1 (26)				
D#1 (27)				
E 1 (28)				
F 1 (29)				
F#1 (30)				
G 1 (31)				
G#1 (32)				
A 1 (33)				
A#1 (34)				
B 1 (35)				
C 2 (36)				
C#2 (37)				
D 2 (38)				
D#2 (39)				
E 2 (40)				
F 2 (41)				
F#2 (42)				
G 2 (43)				
G#2 (44)				
A 2 (45)				
A#2 (46)				
B 2 (47)				
C 3 (48)				
C#3 (49)				
D 3 (50)				
D#3 (51)				
E 3 (52)				
F 3 (53)				
F#3 (54)				
G 3 (55)				
G#3 (56)				
A 3 (57)				
A#3 (58)				
B 3 (59)				
C 4 (60)				
C#4 (61)				
D 4 (62)				
D#4 (63)				
E 4 (64)				
F 4 (65)				
F#4 (66)				
G 4 (67)				
G#4 (68)				
A 4 (69)				
A#4 (70)				
B 4 (71)				

Ch	Dr	Org	Lead	Reverb
C 5 (72)				
C#5 (73)				
D 5 (74)				
D#5 (75)				
E 5 (76)				
F 5 (77)				
F#5 (78)				
G 5 (79)				
G#5 (80)				
A 5 (81)				
A#5 (82)				
B 5 (83)				
C 6 (84)				
C#6 (85)				
D 6 (86)				
D#6 (87)				
E 6 (88)				
F 6 (89)				
F#6 (90)				
G 6 (91)				
G#6 (92)				
A 6 (93)				
A#6 (94)				
B 6 (95)				
C 7 (96)				
C#7 (97)				
D 7 (98)				
D#7 (99)				
E 7 (100)				
F 7 (101)				
F#7 (102)				
G 7 (103)				
G#7 (104)				
A 7 (105)				
A#7 (106)				
B 7 (107)				
C 8 (108)				

Request data : RQD (41H)

This message is sent out when there is a need to acquire data from a device at the other end of the interface. It contains data for the address and size that specify designation and length, respectively, of data required.

On receiving an RQD message, the remote device checks its memory for the data address and size which satisfy the request. If it finds them and is ready for communication, the device will transmit a "Data set (DAT)" message, which contains the requested data. Otherwise, it will return a "Rejection (RJC)" message.

Byte	Description
F0H	Exclusive status
41H	Manufacturer ID (Roland)
DEV	Device ID
MDL	Model ID
41H	Command ID
aaH	Address MSB
⋮	⋮
	LSB
ssH	Size MSB
⋮	⋮
	LSB
sum	Check sum
F7H	End of exclusive

- *The size of the requested data does not indicate the number of bytes that make up a "Data set (DAT)" message, but represents the address fields where the requested data resides.
- *Some models are subject to limitations in data format used for a single transaction. Requested data, for example, may have a limit in length or must be divided into predetermined address fields before it is exchanged across the interface.
- *The same number of bytes comprises address and size data, which, however, vary with the Model-ID.
- *The error checking process uses a checksum that provides a bit pattern where the least significant 7 bits are zero when values for an address, size, and that checksum are summed.

Data set : DAT (42H)

This message corresponds to the actual data transfer process. Because every byte in the data is assigned a unique address, the message can convey the starting address of one or more data as well as a series of data formatted in an address-dependent order.

Although the MIDI standards inhibit non-real time messages from interrupting an exclusive one, some devices support a "soft-through" mechanism for such interrupts. To maintain compatibility with such devices, Roland has limited the DAT to 256bytes so that an excessively long message is sent out in separate segments.

Byte	Description
F0H	Exclusive status
41H	Manufacturer ID (Roland)
DEV	Device ID
MDL	Model ID
42H	Command ID
aaH	Address MSB
⋮	⋮
	LSB
ddH	Data
⋮	⋮
sum	Check sum
F7H	End of exclusive

- *A DAT message is capable of providing only the valid data among those specified by an RQD or WSD message.
- *Some models are subject to limitations in data format used for a single transaction. Requested data, for example, may have a limit in length or must be divided into predetermined address fields before it is exchanged across the interface.
- *The number of bytes comprising address data varies from one model ID to another.
- *The error checking process uses a checksum that provides a bit pattern where the least significant 7 bits are zero when values for an address, size, and that checksum are summed.

Acknowledge : ACK (43H)

This message is sent out when no error was detected on reception of a WSD, DAT, "End of data (EOD)", or some other message and a requested setup or action is complete. Unless it receives an ACK message, the device at the other end will not proceed to the next operation.

Byte	Description
F0H	Exclusive status
41H	Manufacturer ID (Roland)
DEV	Device ID
MDL	Model ID
43H	Command ID
F7H	End of exclusive

End of data : EOD (45H)

This message is sent out to inform a remote device of the end of a message. Communication, however, will not come to an end unless the remote device returns an ACK message even though an EOD message was transmitted.

Byte	Description
F0H	Exclusive status
41H	Manufacturer ID (Roland)
DEV	Device ID
MDL	Model ID
45H	Command ID
F7H	End of exclusive

Communications error : ERR (4EH)

This message warns the remote device of a communications fault encountered during message transmission due, for example, to a checksum error. An ERR message may be replaced with a "Rejection (RJC)" one, which terminates the current message transaction in midstream.

When it receives an ERR message, the sending device may either attempt to send out the last message a second time or terminate communication by sending out an RJC message.

Byte	Description
F0H	Exclusive status
41H	Manufacturer ID (Roland)
DEV	Device ID
MDL	Model ID
4EH	Command ID
F7H	End of exclusive

00 03H	00aa aaaa	LOWER TONE NUMBER	0-63 (1-64)
00 04H	0000 00aa	UPPER TONE GROUP	0-3 (a, b, i, r)
00 05H	00aa aaaa	UPPER TONE NUMBER	0-63 (1-64)
00 06H	00aa aaaa	LOWER KEY SHIFT	0-48 (-24+24)
00 07H	00aa aaaa	UPPER KEY SHIFT	0-48 (-24+24)
00 08H	0aaa aaaa	LOWER FINE TUNE	0-100 (-50+50)
00 09H	0aaa aaaa	UPPER FINE TUNE	0-100 (-50+50)
00 0AH	000a aaaa	LOWER BENDER RANGE	0-24
00 0BH	000a aaaa	UPPER BENDER RANGE	0-24
00 0CH	0000 00aa	LOWER ASSIGN MODE	0-3 (POLY1, POLY2, POLY3, POLY4)
00 0DH	0000 00aa	UPPER ASSIGN MODE	0-3 (POLY1, POLY2, POLY3, POLY4)
00 0EH	0000 000a	LOWER REVERB SWITCH	0-1 (OFF, ON)
00 0FH	0000 000a	UPPER REVERB SWITCH	0-1 (OFF, ON)
00 10H	0000 aaaa	REVERB MODE	0-8 (Room1/2, Hall1/2, Plate, Delay1/2/3, OFF)
00 11H	0000 0aaa	REVERB TIME	0-7 (1-8)
00 12H	0000 0aaa	REVERB LEVEL	0-7
00 13H	0aaa aaaa	U/L BALANCE	0-100 (L max<-->U max)
00 14H	0aaa aaaa	PATCH LEVEL	0-100
00 15H	0aaa aaaa	PATCH NAME CHAR.1	32-127 (ASCII CODE)
:	:	:	:
00 24H	0aaa aaaa	PATCH NAME CHAR.16	
00 25H	0000 0000	dummy (ignored if received)	

Total size = 00 00 26H

Example of RQ1 and DT1 application 2

Unit # is set at 17 in this example.

When D-20 receive the following messages in Performance mode, it sends Patch data from the temporary area.

F0 41 10 16 11 03 04 00 00 00 26 53 F7

*8-5 Timbre memory

Offset address	Description	
00 00H	0000 00aa	TONE GROUP 0-3 (a, b, i, r)
00 01H	00aa aaaa	TONE NUMBER 0-63 (1-64)
00 02H	00aa aaaa	KEY SHIFT 0-48 (-24+24)
00 03H	0aaa aaaa	FINE TUNE 0-100 (-50+50)
00 04H	000a aaaa	BENDER RANGE 0-24
00 05H	0000 00aa	ASSIGN MODE 0-3 (POLY1, POLY2, POLY3, POLY4)
00 06H	0000 000a	REVERB SWITCH 0-1 (OFF, ON)
00 07H	0000 0000	dummy (ignored if received)

Total size = 00 00 08H

*8-6 Rhythm pattern

The data listed below are divided-by-two 8-bit data and sent/received as two 4-bit data. (bbbbaaaa-0000aaaa, 0000bbbb)
Events are listed in an ascending order.

Offset address	Description	
00 00H	0000 0aaa	TIME 0-7 (1/4, 2/4, 3/4, 4/4, 5/4, 6/4, 7/4, 8/4)
00 01H	0000 0000	
00 02H	0000 0aaa	TOTAL # OF NOTES 0-96
00 03H	0000 0bbb	

00 05H	0000 0000	dummy
00 06H	EVENT # 1	*8-6-1
00 0CH	EVENT # 2	
:	:	:
04 3AH	EVENT #95	
04 40H	EVENT #96	
04 46H	0000 1111	END MARK
04 47H	0000 1111	
04 48H	0000 0000	dummy (ignored if received)
04 49H	0000 0000	dummy
04 4AH	0000 0000	dummy (ignored if received)
04 4BH	0000 0000	dummy

Total size = 00 04 4CH

*8-6-1 Event

Offset address	Description	
00 00H	0000 aaaa	STEP 0-191
00 01H	0000 bbbb	
00 02H	0000 aaaa	NOTE NUMBER 24-108
00 03H	0000 0bbb	
00 04H	0000 aaaa	VELOCITY 1-127
00 05H	0000 0bbb	

*8-7 Rhythm track

Offset address	Description	
00 00H	0aaa aaaa	TRACK LENGTH LSB 0-500
00 01H	0000 00aa	TRACK LENGTH MSB
00 02H	0aaa aaaa	Pattern 1 0-63, 64-71 (P-11 - P-68, Blank 1-8)
:	:	:
03 75H	0aaa aaaa	Pattern 500

Total size = 00 03 76H

*8-8 System area

When All is selected for bulk dump/load in data transfer mode, data in this area are transmitted or received together with associated sound data and rhythm data.

Partial reserve must be sent as a package of 9 parts, which in total, should contain no more than 32 partials.

Offset address	Description	
00 00H	0aaa aaaa	MASTER TUNE 0-127 (432.1Hz 457.6Hz)
00 01H	0000 aaaa	REVERB MODE 0-8 (Room1/2, Hall1/2, Plate, Delay1/2/3, OFF)
00 02H	0000 0aaa	REVERB TIME 0-7 (1-8)
00 03H	0000 0aaa	REVERB LEVEL 0-7
00 04H	00aa aaaa	PARTIAL RESERVE (Part 1) 0-32
00 05H	00aa aaaa	PARTIAL RESERVE (Part 2) 0-32
00 06H	00aa aaaa	PARTIAL RESERVE (Part 3) 0-32
00 07H	00aa aaaa	PARTIAL RESERVE (Part 4) 0-32
00 08H	00aa aaaa	PARTIAL RESERVE (Part 5) 0-32
00 09H	00aa aaaa	PARTIAL RESERVE (Part 6) 0-32
00 0AH	00aa aaaa	PARTIAL RESERVE (Part 7) 0-32
00 0BH	00aa aaaa	PARTIAL RESERVE (Part 8) 0-32
00 0CH	00aa aaaa	PARTIAL RESERVE (Part R) 0-32
00 0DH	0000 0000	dummy (for D-110)
:	:	:
00 20H	0000 0000	dummy (for D-110)
00 21H	0aaa aaaa	OUTPUT LEVEL (Part 1) 0-100
00 22H	0aaa aaaa	OUTPUT LEVEL (Part 2) 0-100
00 23H	0aaa aaaa	OUTPUT LEVEL (Part 3) 0-100
00 24H	0aaa aaaa	OUTPUT LEVEL (Part 4) 0-100
00 25H	0aaa aaaa	OUTPUT LEVEL (Part 5) 0-100
00 26H	0aaa aaaa	OUTPUT LEVEL (Part 6) 0-100
00 27H	0aaa aaaa	OUTPUT LEVEL (Part 7) 0-100
00 28H	0aaa aaaa	OUTPUT LEVEL (Part 8) 0-100
00 29H	0aaa aaaa	OUTPUT LEVEL (Part R) 0-100
00 2AH	0000 aaaa	PANPOT (Part 1) 0-14
00 2BH	0000 aaaa	PANPOT (Part 2) 0-14
00 2CH	0000 aaaa	PANPOT (Part 3) 0-14
00 2DH	0000 aaaa	PANPOT (Part 4) 0-14
00 2EH	0000 aaaa	PANPOT (Part 5) 0-14
00 2FH	0000 aaaa	PANPOT (Part 6) 0-14
00 30H	0000 aaaa	PANPOT (Part 7) 0-14
00 31H	0000 aaaa	PANPOT (Part 8) 0-14

Total size = 00 00 32H

Example of RQ1 and DT1 application ... 3

Unit # is set at 17 in this example.

The byte string shown below will set Partial reserve of each part as follows :

Part 1 ... 8 Part 3 thru 8 ... 0
 Part 2 ... 10 Rhythm part ... 8

F0 41 10 16 12 10 00 04 00 08 0A 00 00 00 00 00 08 66 F7

*8-9 DISPLAY

D-20 deciphers incoming data and sends them to the LCD as a string of ASCII code characters.

The display data in this area cannot be brought outside D-20 through MIDI message, such as RQ1 and DT1.

Offset address	Description
00H	0aaa aaaa DISPLAYED LETTER 32-127 (ASCII)
:	:
1FH	0aaa aaaa DISPLAYED LETTER

Total size = 00 00 20H

*8-10 Write Request

This message simulates write switch: D-20 stores the data of each part in the temporary area into individual memory locations specified by two byte data. Timbre write is effective only in Multi timbral mode; Patch write only in Performance mode.

The data in this area cannot be brought outside D-20 through MIDI message, such as RQ1 and DT1.

D-20 returns the result to the transmitter.

Offset address	Description
00 00H	00aa aaaa Tone Write (part 1/upper) 0-63 (01-64)
00 01H	0000 000a 0, 1 (Internal, Card)
00 02H	00aa aaaa Tone Write (part 2/lower)
00 03H	0000 000a
:	:
00 0EH	00aa aaaa Tone Write (part 8)
00 0FH	0000 000a
01 00H	0aaa aaaa Timbre Write (part 1) 0-127 (A11-B88)
01 01H	0000 000a 0, 1 (Internal, Card)
01 02H	0aaa aaaa Timbre Write (part 2)
01 03H	0000 000a
:	:
01 0EH	0aaa aaaa Timbre Write (part 8)
01 0FH	0000 000a
03 00H	0aaa aaaa Patch Write 0-127 (A11-B88)
03 01H	0000 000a 0, 1 (Internal, Card)
10 00H	0000 00aa Result 0-3

0=Function Completed
 1=Card Not Ready
 2=Write Protected
 3=Incorrect Mod

Example of RQ1 and DT1 application ... 4

Unit # is set at 17 in this example.

Sending the following byte string will enable D-20 to write data in Part 3 in temporary data into 1-B24.

F0 41 10 16 12 40 04 4B 00 71 F7

Address Map

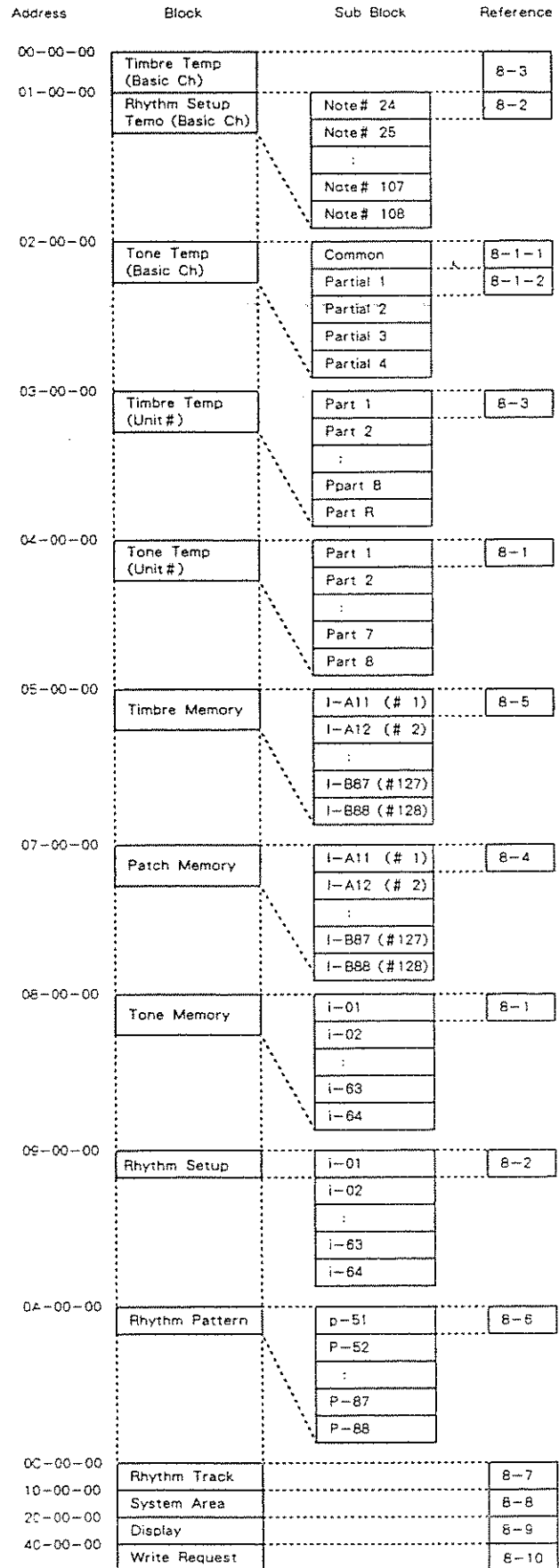

RPC MSB

Status	Second	Third
BnH	65H	vvH

vv=MSB of the parameter number controlled by RPC
00H-7FH (0-127)
n=MIDI channel 0H-FH (1-16)

Program Change

Patch/Timbre change

Status	Second
CnH	ppH

pp=Program number 00H-7FH (0-127)
n=MIDI channel 0H-FH (1-16)

Pitch Bender Change

Pitch bender

Status	Second	Third
EnH	vvH	vvH

vv=Pitch bender change value
n=MIDI channel 0H-FH (1-16)

3.2 GENERATED MESSAGES

Mode Message

All notes off

Status	Second	Third
BnH	7BH	00H

n=MIDI channel 0H-FH (1-16)

Transmitted when all notes in a muted track have been turned off with MIDI All Notes Off function set at On. Transmitted channel: Set by MIDI function in Multi timbral mode.

Timing Clock

Status
F8H

Transmitted only when in Internal clock mode.

Start

Status
FAH

Transmitted only when in Internal clock mode.
Panel operation: Press Start button while holding Stop button.

Continue

Status
FBH

Transmitted only when in Internal clock mode.
Panel operation: Press Start button.

Stop

Status
FCH

Transmitted only when in Internal clock mode.
Panel operation: Press Stop button.

4. RECOGNIZED RECEIVE DATA (Synthesizer Section)

Note Event

Note off

Status	Second	Third
8nH	kkH	vvH
9nH	kkH	00H

kk=Note number 00H-7FH (0-127)
vv=Velocity ignored
n=MIDI channel 0H-FH (1-16)

Note on

Status	Second	Third
9nH	kkH	vvH

kk=Note number 00H-7FH (0-127)
vv=Velocity 01H-7FH (1-127)
n=MIDI channel 0H-FH (1-16)

Note numbers outside of the range 12-108 are transposed to the nearest octave inside the range.

Control Change

Modulation depth

Status	Second	Third
BnH	01H	vvH

vv=Modulation depth 00H-7FH (0-127)
n=MIDI channel 0H-FH (1-16)

In Performance mode, recognized when MIDI Modulation function is on.
In Multi timbral mode, always recognized.

Data entry

Status	Second	Third
BnH	06H	vvH

vv=Value of RPC 00H-18H (0-24)
n=MIDI channel 0H-FH (1-16)

Recognized a a value corresponding to the parameter specified by RPC.
See RPC MSB section.

Main volume

Status	Second	Third
BnH	07H	vvH

vv=Volume value 00H-7FH (0-127)
n=MIDI channel 0H-FH (1-16)

In Performance mode, recognized when MIDI Volume function is on.
In Multi timbral mode, always recognized.
Can control the volume of the Parts played through the same MIDI channel.
The maximum volume is determined by the Volume knob and Expression message.

Panpot

Status	Second	Third
BnH	0AH	vvH

vv=Panpot value 00H-7FH (0-127)
n=MIDI channel 0H-FH (1-16)

Ignored when in Performance mode.
Moving direction of sound is as follows.

0=LEFT, 63=CENTER, 127=RIGHT

Expression

Status	Second	Third
BnH	0BH	vvH

vv=Expression 00H-7FH (0-127)
n=MIDI channel 0H-FH (1-16)

Can control the volume of the parts played through the same MIDI channel.
The maximum volume is determined by the Volume knob and Main volume message.

2. TRANSMITTED DATA (Rhythm Section)

Note Event

Note off

Status	Second	Third
9nH	kkH	00l

kk=Note number 18H-6CH (24-108)
n=MIDI channel 0H-FH (1-16)

Note on

Status	Second	Third
9nH	kkH	vvH

kk=Note number 18H-6CH (24-108)
vv=Velocity 01H-7FH (1-127)
n=MIDI channel 0H-FH (1-16)

transmitted on the MIDI channel being assigned to rhythm part when a rhythm pattern is played in internal clock mode.

Exclusive

Status
F0H : System exclusive
F7H : EOX (End of exclusive)

Used for Bulk dump/load operation.
Refer to Section 7 for details.

Timing Clock

Status
F8H

Transmitted only when Clock mode is Internal.

Start

Status
FAH

Transmitted only when in Internal clock mode.
Panel operation : Press Start button while holding Stop button.

Continue

Status
FBH

Transmitted only when in Internal clock mode.
Panel operation : Press Start button.

Stop

Status
FCH

Transmitted only when in Internal clock mode.
Panel operation : Press Stop button.

3. TRANSMITTED DATA (Sequencer Section)

The sequencer has 9 tracks : 8 for 8 synth parts and one for sog of rhythm.

3.1 TRANSMITTED VOICE MESSAGES IN PLAYBACK

Muting a track will enable D-20 to transmit data stored in that track --- on the MIDI channel set by MIDI function in Multi timbral mode.

Note Event

Note off

Status	Second	Third
9nH	kkH	00H

kk=Note number 00H-7FH (0-127)
n=MIDI channel 0H-FH (1-16)

Note on

Status	Second	Third
9nH	kkH	vvH

kk=Note number 00H-7FH (0-127)
vv=Velocity 01H-7FH (1-127)
n=MIDI channel 0H-FH (1-16)

Control Change

Modulation depth

Status	Second	Third
BnH	01H	vvH

vv=Modulation depth 00H-7FH (0-127)
n=MIDI channel 0H-FH (1-16)

Data entry

Status	Second	Third
BnH	06H	vvH

vv=Value of RPC 00H-7FH (0-127)
n=MIDI channel 0H-FH (1-16)

Main volume

Status	Second	Third
BnH	07H	vvH

vv=Volume value 00H-7FH (0-127)
n=MIDI channel 0H-FH (1-16)

Panpot

Status	Second	Third
BnH	0AH	vvH

vv=Panpot value 00H-7FH (0-127)
n=MIDI channel 0H-FH (1-16)

Expression

Status	Second	Third
BnH	0BH	vvH

vv=Expression 00H-7FH (0-127)
n=MIDI channel 0H-FH (1-16)

Hold- 1

Status	Second	Third
BnH	40H	vvH

vv=00H-3FH (0-63) : Off
vv=40H-7FH (64-127) : On
n=MIDI channel 0H-FH (1-16)

RPC LSB

Status	Second	Third
BnH	64H	vvH

vv=LSB of the parameter number controlled by RPC
00H-7FH (0-127)
n=MIDI channel 0H-FH (1-16)

6. RECOGNIZED RECEIVE DATA (Sequencer Section)

6.1 RECORDED MESSAGES

During external recording, each of the following messages is recorded onto the track assigned to the MIDI channel in a part. The MIDI channel is the channel set by MIDI function in Multi timbral mode.

■ Note Event

Note off

Status	Second	Third
8nH	kkH	vvH
9nH	kkH	00H

kk = Note number 00H-7FH (0-127)
 vv = Velocity ignored
 n = MIDI channel 0H-FH (1-16)

Note on

Status	Second	Third
9nH	kkH	vvH

kk = Note number 00H-7FH (0-127)
 vv = Velocity 01H-7FH (1-127)
 n = MIDI channel 0H-FH (1-16)

■ Control Change

Modulation depth

Status	Second	Third
BnH	01H	vvH

vv = Modulation depth 00H-7FH (0-127)
 n = MIDI channel 0H-FH (1-16)

Data entry

Status	Second	Third
BnH	06H	vvH

vv = Value of RPC 00H-7FH (0-127)
 n = MIDI channel 0H-FH (1-16)

Main volume

Status	Second	Third
BnH	07H	vvH

vv = Volume value 00H-7FH (0-127)
 n = MIDI channel 0H-FH (1-16)

Panpot

Status	Second	Third
BnH	0AH	vvH

vv = Panpot value 00H-7FH (0-127)
 n = MIDI channel 0H-FH (1-16)

Expression

Status	Second	Third
BnH	0BH	vvH

vv = Expression 00H-7FH (0-127)
 n = MIDI channel 0H-FH (1-16)

Hold-1

Status	Second	Third
BnH	40H	vvH

vv = 00H-3FH (0-63) : Off
 vv = 40H-7FH (64-127) : On
 n = MIDI channel 0H-FH (1-16)

RPC LSB

Status	Second	Third
BnH	64H	vvH

vv = LSB of the parameter number controlled by RPC
 00H-7FH (0-127)
 n = MIDI channel 0H-FH (1-16)

RPC MSB

Status	Second	Third
BnH	65H	vvH

vv = MSB of the parameter number controlled by RPC
 00H-7FH (0-127)
 n = MIDI channel 0H-FH (1-16)

■ Program Change

Patch/Timbre change

Status	Second	Third
CnH	ppH	

pp = Program number 00H-7FH (0-127)
 n = MIDI channel 0H-FH (1-16)

■ Pitch bender change

Pitch bender

Status	Second	Third
EnH	vvH	vvH

vv vv = Pitch bender change value
 n = MIDI channel 0H-FH (1-16)

6.2 RECOGNIZED DATA IN RECORDING

During external recording, following messages are recognized but not memorized as performance information. Receiving channel: MIDI channel set by MIDI function in Multi timbral mode.

■ Mode Message

All notes off

Status	Second	Third
BnH	7BH	00H

n = MIDI channel 0H-FH (1-16)

This message causes the D-20 to generate and retain Note off events for the notes turned on by MIDI.

OMNI off

Status	Second	Third
BnH	7CH	00H

n = MIDI channel 0H-FH (1-16)

OMNI on

Status	Second	Third
BnH	7DH	00H

n = MIDI channel 0H-FH (1-16)

MONO

Status	Second	Third
BnH	7EH	mmH

mm = MONO channel range ignored
 n = MIDI channel 0H-FH (1-16)

POLY

Status	Second	Third
BnH	7FH	00H

n = MIDI channel 0H-FH (1-16)

OMNI off, OMNI on, POLY and MONO are recognized as All notes off only.

6.3 Recognized Synchronizing Messages

■ Timing Clock

Status
F8H

Recognized only when Clock mode is MIDI.

Start

Status
FAH

Recognized only when Clock mode is MIDI.

Continue

Status
FBH

Recognized only when Clock mode is MIDI.

Stop

Status
FCH

Recognized only when Clock mode is MIDI.

7. EXCLUSIVE COMMUNICATION

A set of parameters of a patch or timbre can be transmitted to/from D-20 using one way MIDI exclusive message. Bulk dumping/loading of internal memory can be performed using either of one way or handshaking communication.

Model-ID# in the exclusive message: 16H

In addition to usual MIDI channel, each D-20 can be provided with a unique ID# called unit # through which any part is made accessible independently of its MIDI channel.

MIDI channel: 1-16 Unit #: 17-32

Whether to use MIDI channel or unit # is dependent on application -- refer to description on each message.

NOTE: MIDI standard states that channel starts with "0". So the actual Device # is a number that is "1" subtracted from the above-mentioned channel number or unit #.

One-Way Communication

Request data RQ1 11H

When the RQ1 received contains start address listed in the Parameter base address table; and address size is 1 or more, D-20 sends the data stored in that address location and the subsequent locations, if any.

Byte	Description
F0H	Exclusive status
41H	Manufactures ID (Roland)
DEV	Device ID
16H	Model ID
11H	Command ID
aaH	Address MSB *7-1
aaH	Address
aaH	Address LSB
ssH	Size MSB
ssH	Size
ssH	Size LSB
sum	Check sum
F7H	End of exclusive

Data set 1 DT1 12H

When D-20 is receiver:

- D-20 recognizes this message when it has a unit # (17-32) which is indicated on MIDI function display. If the address specified in the message corresponds to the current mode (Performance or Multi timbral) parameter base address, D-20 stores the data into that and subsequent address locations.
Device-ID# = MIDI channel # less 1 or Unit # less 1
- When D-20 receives this message while executing one way bulk loading in data transfer mode with or without having unit #; And if the address specified in the message corresponds to one of the following parameter base addresses, D-20 stores coming data into that and subsequent address locations.
Timbre memory
Patch memory
Tone memory
Rhythm setup
Rhythm pattern
Rhythm track
System area
Device-ID# -----
When unit # is specified by MIDI function: Unit # less 1. If not specified: 10H

When D-20 is transmitter:

- With unit # (17-32) set
Transmits data directed by RQ1.
Device-ID# = Unit # less 1
- 1) With unit # (17-32) set and Patch dump on (Performance mode) Modifying timbre from the D-20 panel causes it to send program change message and parameter data of a patch.
- 2) With unit # (17-32) set and Timbre dump on (Multi timbral mode) Modifying timbre from the D-20 panel causes it to send program change message and parameter data of a timbre.
Device-ID# :
Performance mode -- Unit # less 1
Multi timbral mode -----
LCD is showing part status: Unit # less 1
LCD is showing keyboard: Transmitting channel number less 1
- D-20 sends this message when one way dump is executed in Data transfer mode.
Transferable addresses:
Timbre memory
Patch memory
Tone memory
Rhythm setup
Rhythm pattern
Rhythm track
System area
Device-ID# :
With Unit # set ---- Unit # less 1
Without Unit # ----- 10H

Refer to Section 8 Parameter Address Map for transferable parameters.

Byte	Description
F0H	Exclusive status
41H	Manufactures ID (Roland)
DEV	Device ID
16H	Model ID
12H	Command ID
aaH	Address MSB *7-1
aaH	Address
aaH	Address LSB
ddH	Data *7-2
:	:
sum	Check sum
F7H	End of exclusive

Handshake Communication

Bulk dump/load to an from D-20 through handshaking communication in Data transfer mode starts with the following message.

Device-ID# :
With Unit # set ---- Unit # less 1
Without Unit # ----- 10H

Addresses containable in the bulk dump/load messages:

Timbre memory
Patch memory
Tone memory
Rhythm setup
Rhythm pattern
Rhythm track
System area

Want to send data WSD 40H

D-20 sends acknowledge upon receiving this message and waits for coming data.

Byte	Description
F0H	Exclusive status
41H	Manufactures ID (Roland)
DEV	Device ID
16H	Model ID
40H	Command ID
aaH	Address MSB *7-1
aaH	Address
aaH	Address LSB
ssH	Size MSB
ssH	Size
ssH	Size LSB
sum	Check su
F7H	End of exclusive

5. RECOGNIZED RECEIVE DATA (Rhythm Section)

Note Event

Note off

Status	Second	Third
8nH	kkH	vvH
9nH	kkH	00H

kk = Note number 18H-6CH (24-108)
 vv = Velocity ignored
 n = MIDI channel 0H-FH (1-16)

Note on

Status	Second	Third
9nH	kkH	vvH

kk = Note number 18H-6CH (24-108)
 vv = Velocity 01H-7FH (1-127)
 n = MIDI channel 0H-FH (1-16)

Note numbers outside of the range 24-108 are ignored.

Control Change

Data entry

Status	Second	Third
BnH	06H	vvH

vv = Value of RPC 00H-18H (0-24)
 n = MIDI channel 0H-FH (1-16)

Recognized as a value corresponding to the parameter specified by RPC.

Main volume

Status	Second	Third
BnH	07H	vvH

vv = Volume value 00H-7FH (0-127)
 n = MIDI channel 0H-FH (1-16)

Can control the volume of the Rhythm section.
 The maximum volume is determined by the Volume knob setting and Expression message.

Expression

Status	Second	Third
BnH	0BH	vvH

vv = Expression 00H-7FH (0-127)
 n = MIDI channel 0H-FH (1-16)

Can control the volume of the Rhythm section.
 The maximum volume is determined by the volume knob setting and Main volume message.

RPC LSB

Status	Second	Third
BnH	64H	vvH

vv = LSB of parameter number controlled by RPC
 n = MIDI channel 0H-FH (1-16)

See: RPC MSB section.

RPC MSB

Status	Second	Third
BnH	65H	vvH

vv = MSB of parameter number controlled by RPC
 n = MIDI channel 0H-FH (1-16)

Using MIDI RPC, parameters can be changed by Control change messages. RPC MSB and LSB specify the parameter to be controlled, and Data entry shows the parameter value.

RPC	Data entry	Description
MSB LSB	vvH	Parameter Range (vv=0-24)

Reset all controllers

Status	Second	Third
BnH	79H	00H

When Reset All Controllers is recognized, each of the following controllers is set as follows.

Controller	setting
Main volume	MAX (127)
Expression	MAX (127)
Pitch bender change	CENTER

Pitch Bender Change

Pitch bender

Status	Second	Third
EnH	vvH	vvH

vv vv = Pitch bender change value
 n = MIDI channel 0H-FH (1-16)

Exclusive

Status
F0H : System exclusive
F7H : EOX (End of exclusive)

Used for Bulk dump/load operation.
 Refer to Section 7 for details.

Timing Clock

Status
F8H

Recognized only when Clock mode is MIDI.

Start

Status
FAH

Recognized only when Clock mode is MIDI.

Continue

Status
FBH

Recognized only when Clock mode is MIDI.

Stop

Status
FCH

Recognized only when Clock mode is MIDI.

Hold-1

<u>Status</u>	<u>Second</u>	<u>Third</u>
BnH	40H	vvH

vv=00H-3FH (0-63) : Off
 vv=40H-7FH (64-127) : On
 n=MIDI channel 0H-FH (1-16)

In Performance mode, recognized when MIDI Hold function is on.
 In Multi timbral mode, always recognized.

RPC LSB

<u>Status</u>	<u>Second</u>	<u>Third</u>
BnH	64H	vvH

vv=LSB of the parameter number controlled by RPC
 n=MIDI channel 0H-FH (1-16)

See RPC MSB section.

RPC MSB

<u>Status</u>	<u>Second</u>	<u>Third</u>
BnH	65H	vvH

vv=MSB of the parameter number controlled by RPC
 n=MIDI channel 0H-FH (1-16)

Using MIDI RPC, parameters can be changed by Control change message. RPC MSB and LSB specify the parameter to be controlled, while Data entry sets the parameter value.

RPC MSB LSB	Data entry	Description
00H 00H	vvH	Bender Range (vv=0-24)

Reset all controllers

<u>Status</u>	<u>Second</u>	<u>Third</u>
BnH	79H	00H

n=MIDI channel 0H-FH (1-16)

When Reset all controllers is recognized, controllers are set to the following value.

Controller	Setting
Modulation Depth	OFF (0)
Main Volume	MAX (127)
Expression	MAX (127)
Hold1	OFF (0)
Pitch Bender Change	CENTER

Program Change

Patch/Timbre change

<u>Status</u>	<u>Second</u>
CnH	ppH

pp=Program number 00H-7FH (0-127)
 n=MIDI channel 0H-FH (1-16)

In Performance mode, recognized when MIDI Prog. Change function is on and the Patch is changed.
 In Multi timbral mode, always recognized and the Timbre is changed.
 Cannot switch between Internal and Card through MIDI Program change message.

pp	A/B	BANK	NUMBER
00H (00)	A	1	1
:	:	:	:
3FH (63)	A	8	8
40H (64)	B	1	1
:	:	:	:
7FH (127)	B	8	8

Pitch Bender Change

Pitch bender

<u>Status</u>	<u>Second</u>	<u>Third</u>
EnH	vvH	vvH

vv vv=Pitch bender change value
 n=MIDI channel 0H-FH (1-16)

In Performance mode, recognized when MIDI Bender function is on.
 In Multi timbral mode, always recognized.

Mode Message

Local control

<u>Status</u>	<u>Second</u>	<u>Third</u>
BnH	7AH	vvH

vv=00H (0) : Off
 vv=7FH (127) : On
 n=MIDI Channel 0H-FH (1-16)

Recognized in performance mode only.

All notes off

<u>Status</u>	<u>Second</u>	<u>Third</u>
BnH	7BH	00H

n=MIDI channel 0H-FH (1-16)

When All notes off is recognized, all the notes which have been turned on by Note on message are turned off.

OMNI off

<u>Status</u>	<u>Second</u>	<u>Third</u>
BnH	7CH	00H

n=MIDI channel 0H-FH (1-16)

Recognized as All notes off only.
 The D-20 stays in MODE 3.

OMNI on

<u>Status</u>	<u>Second</u>	<u>Third</u>
BnH	7DH	00H

n=MIDI channel 0H-FH (1-16)

Recognized as All notes off only.
 The D-20 stays in MODE 3.

MONO

<u>Status</u>	<u>Second</u>	<u>Third</u>
BnH	7EH	mmH

mm=MONO channel range ignored
 n=MIDI channel 0H-FH (1-16)

Recognized as All notes off only.
 The D-20 stays in MODE 3.

POLY

<u>Status</u>	<u>Second</u>	<u>Third</u>
BnH	7FH	00H

n=MIDI channel 0H-FH (1-16)

Recognized as All notes off only.
 The D-20 stays in mode 3.

Exclusive

Status
 FDH : System exclusive
 F7H : EOX (End of exclusive)

A set of Patch/Timbre parameters will be received when MIDI Exclusive function is on.
 When in Multi timbral mode and if Device-ID contains "MIDI Channel number less 1", the timbre parameters enter into the parts of the same MIDI channel; if Device-ID contains "Unit number less 1", into the parts specified by address in the exclusive message.
 In performance mode "Unit number less 1" is effective.

Also used for Bulk dump/load operation.
 Refer to Section 7 for details.

Active Sensing

Status
 FEH : Active sensing

Having received this message, the D-20 expects to accept status or data in sequence, at least within 300ms intervals. If the unit fails to receive a message 300ms after the previous one, it judges there is a problem somewhere in MIDI path, muting the current sound and stopping 300ms-interval monitoring of incoming signal.

1. TRANSMITTED DATA (Synthesizer Section)

■ Note Event

Note off

Status	Second	Third
9nH	kkH	00H

kk=Note number 18H-6CH (24-108)
n=MIDI channel 0H-FH (1-16)

Note on

Status	Second	Third
9nH	kkH	vvH

kk=Note number 18H-6CH (24-108)
vv=Velocity 01H-7FH (1-127)
n=MIDI channel 0H-FH (1-16)

■ Control Change

Modulation depth

Status	Second	Third
BnH	01H	vvH

vv=Modulation depth 00H-7FH (0-127)
n=MIDI channel 0H-FH (1-16)

In Performance mode, transmitted when MIDI Modulation function is on.
In Multi timbral mode, transmitted on both upper and lower MIDI TX channels of the keyboard.
D-20 does not transmit this message repeatedly if both channels are the same.

Hold-1

Status	Second	Third
BnH	40H	vvH

vv=00H (0) : Off
vv=7FH (127) : On
n=MIDI channel 0H-FH (1-16)

In Performance mode, transmitted when MIDI Hold function is 0.
In Multi timbral mode, transmitted on the MIDI TX channel of upper and lower sides of the keyboard.
D-20 does not transmit this message repeatedly if both channels are the same.

Reset all controllers

Status	Second	Third
BnH	79H	00H

n=MIDI channel 0H-FH (1-16)

Transmitted upon changing modes (Performance ↔ Multi timbral) or MIDI channels (on the previous channel).

■ Program Change

Patch/Timbre change

Status	Second
CnH	ppH

pp=Program number 00H-7FH (0-127)
n=MIDI channel 0H-FH (1-16)

In Performance mode, transmitted when MIDI Program change function is on.
In Multi timbral mode and when the LCD is showing the status of either of upper or lower keyboard, transmitted on the MIDI TX channel assigned to the keyboard.

■ Pitch Bender Change

Pitch bender

Status	Second	Third
EnH	vvH	vvH

vv=Pitch bender change value
n=MIDI channel 0H-FH (1-16)

In Performance mode, transmitted when MIDI Bender function is on.
In Multi timbral mode, transmitted on the MIDI TX channel of both upper and lower sides of keyboard.
Transmitted only once if both TX channels are the same.

pp	A/B	BANK	NUMBER
00H (00)	A	1	1
:	:	:	:
3FH (63)	A	8	8
40H (64)	B	1	1
:	:	:	:
7FH (127)	B	8	8

■ Mode Message

All notes off

Status	Second	Third
BnH	7BH	00H

n=MIDI channel 0H-FH (1-16)

When MIDI All notes off function is on, will be transmitted upon release of all the keys after pressing a key(s).

OMNI off

Status	Second	Third
BnH	7CH	00H

n=MIDI channel 0H-FH (1-16)

Transmitted on power-up or when MIDI TX channel is changed to the new channel (always accompanied by "POLY").
In Multi timbral mode, transmitted on the MIDI TX channel of both upper side and lower side of keyboard.
Transmitted only once if both channels are the same.

Poly

Status	Second	Third
BnH	7FH	00H

n=MIDI channel 0H-FH (1-16)

Transmitted on power-up or when MIDI TX channel is changed to the new channel. (Always accompanied by "OMNI OFF".)
In Multi timbral mode, transmitted on the MIDI TX channel of both upper side and lower side of keyboard.
Transmitted only once if both channels are the same.

■ Exclusive

Status
F0H : System exclusive
F7H : EOX (End of exclusive)

A set of Patch/Timbre parameters is transmitted when MIDI Patch dump function is on.
The contents in Device-ID is either of the following two: unit number and MIDI channel number. The type of the information in the Device-ID can be determined from the display mode:

When display is showing,
(in Multi timbral mode)
Part --- unit number less 1
Keyboard status --- MIDI channel less 1
(in Performance mode)
unit number less 1
Also used for Bulk dump/load operation.
Refer to Section 7 for details.

■ Active Sensing

Status
FEH : Active sensing

Transmitted for checking MIDI connection between D-20 and external equipment.
Cannot be transmitted during disk operation in data transfer mode.

Rejection : RJC (4FH)

This message is sent out when there is a need to terminate communication by overriding the current message. An RJC message will be triggered when :

- a WSD or RQD message has specified an illegal data address or size,
- the device is not ready for communication.
- an illegal number of addresses or data has been detected.
- data transfer has been terminated by an operator.
- a communications error has occurred.

An ERR message may be sent out by a device on either side of the interface. Communication must be terminated immediately when either side triggers an ERR message.

Byte	Description
F0H	Exclusive status
41H	Manufacturer ID (Roland)
DEV	Device ID
MDL	Model ID
4FH	Command ID
F7H	End of exclusive

Example of Message Transactions

- Data transfer from device (A) to device (B).

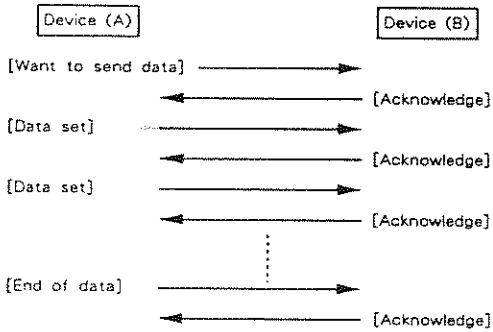

- Device (A) requests and receives data from device (B).

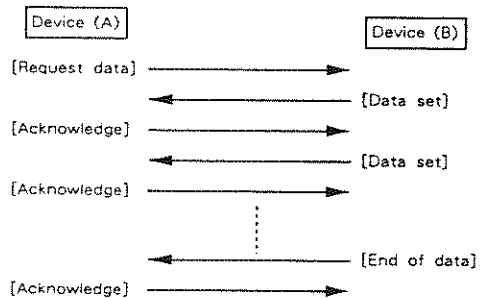

- Error occurs while device (A) is receiving data from device (B).

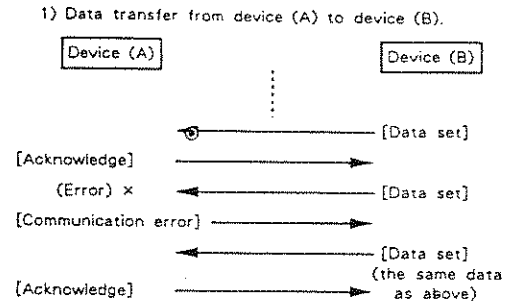

- 2) Device (B) rejects the data re-transmitted, and quits data transfer.

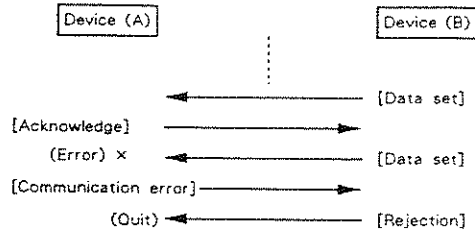

- 3) Device (A) immediately quits data transfer.

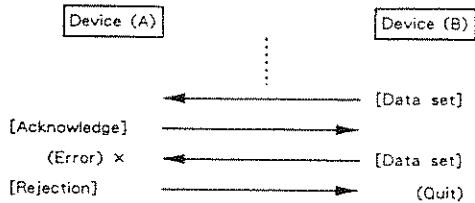

MIDI Implementation Chart

Function...		Transmitted	Recognized	Remarks
Basic Channel	Default Changed	* 1-16 X	* 1-16 X	Memorized
Mode	Default Messages Altered	X X *****	Mode 3 X	
Note Number	True Voice	0-127 *****	0-127 0-127	
Velocity	Note ON Note OFF	*** X 9n v=0 (***)	O v=1-127 X	
After Touch	Key's Ch's	X X	X X	
Pitch Bender		***	O	
Control Change	1	***	O	Modulation Data entry Volume Panpot Expression
	6	***	O	
	7	***	O	
	10	***	O	
	11	***	O	
	64	***	O	Hold 1 RPC LSB, MSB
	100, 101	***	O	
Prog Change	True #	*** *****	O 0-127 0-127	
System Exclusive		X	X	
System Common	Song Pos	X	X	
	Song Sel	X	X	
	Tune	X	X	
System Real Time	Clock Commands	O (Clock mode=INT) O (Clock mode=INT)	O (Clock mode=MIDI) O (Clock mode=MIDI)	
	Aux Message	X *** X X	X O (123-127) X X	
Notes		* Channel number of a part. ** Can be set to O or X manually. *** Transmitted when the track is muted. **** Can be set to O or X manually. Only the data in a muted track is made transferable.		

MEMO

 Roland®

10688

UPC

10688



10961

 Roland®